

Technical Teaching Equipment

Summarized
Catalogue

three⁽³⁾

Mechanics & Materials



www.edibon.com

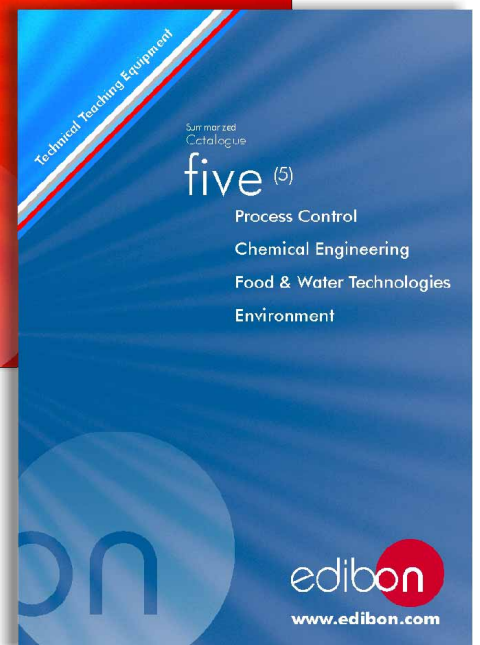
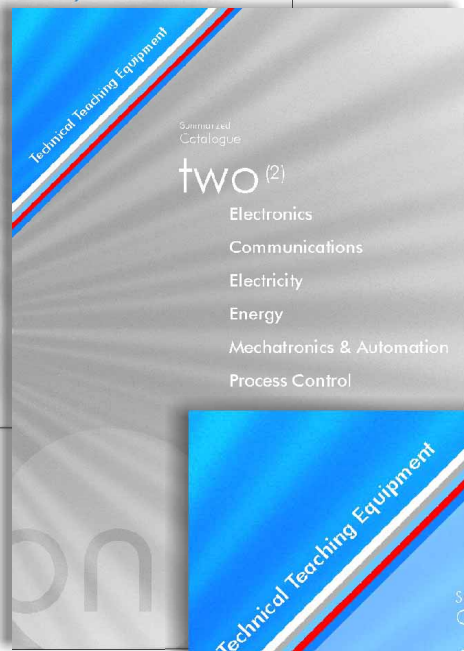
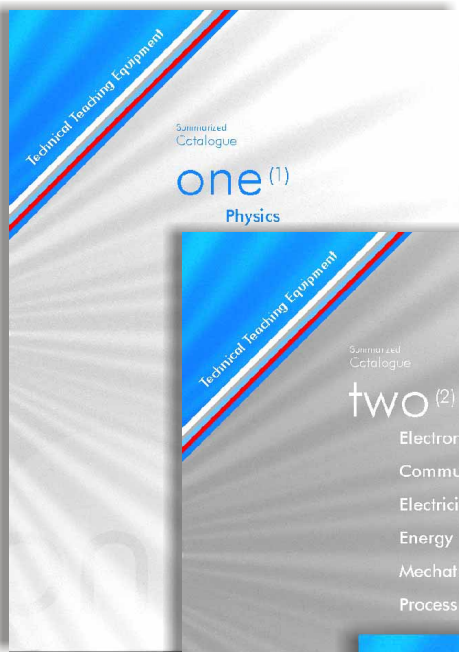

three (3)

7. Mechanics & Materials

page 4

7.1.	Basic Mechanics.	6-9
7.2.	General Mechanics:	
	7.2.1. Automotive Mechanisms.	10-11
	7.2.2. Gears and Transmissions.	11-13
	7.2.3. Mechanisms.	13-16
	7.2.4. Lubrication. Wear. Friction.	16
7.3.	Automotive.	16
7.4.	Special Mechanics & Foundry.	17
7.5.	Strength of Materials:	
	7.5.1. General Strength of Materials.	18-25
	7.5.2. Strength of Materials (Photoelasticity).	26-28
7.6.	Basic Cut Away Mechanics.	
7.7.	General Cut Away Mechanics.	
7.8.	Building.	29-30
7.9.	Civil Engineering.	
7.10.	Agricultural Engineering.	
7.11.	Other Engineerings.	

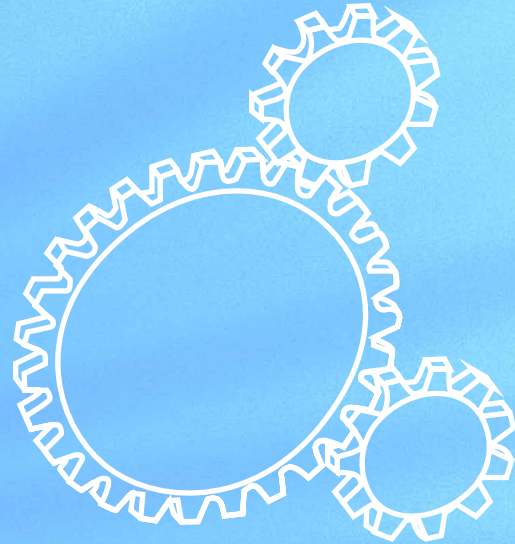

7. Mechanics & Materials

	page
7.1. Basic Mechanics.	6-9
7.2. General Mechanics:	
7.2.1. Automotive Mechanisms.	10-11
7.2.2. Gears and Transmissions.	11-13
7.2.3. Mechanisms.	13-16
7.2.4. Lubrication. Wear. Friction.	16
7.3. Automotive.	16
7.4. Special Mechanics & Foundry.	17
7.5. Strength of Materials:	
7.5.1. General Strength of Materials.	18-25
7.5.2. Strength of Materials (Photoelasticity).	26-28
7.6. Basic Cut Away Mechanics	
7.7. General Cut Away Mechanics.	
7.8. Building.	29-30
7.9. Civil Engineering.	
7.10. Agricultural Engineering.	
7.11. Other Engineerings.	

7.- Mechanics & Materials

Equipment list

	page		page			
7.1- Basic Mechanics		7.4- Special Mechanics & Foundry				
-LIMEBA	Basic Mechanics Integrated Laboratory:	6-9	-MCAM	Bell Casting Basic Training Set.	17	
	Modules		-MCLA	Foundry Building-up Training Set 1.	17	
	•MECA1	Statics Experiments.		-MCEN	Centrifugal Casting Building-up Training Set 2.	17
	•MECA2	Load Elevation Mechanisms Experiments.	7.5- Strength of Materials			
	•MECA3	Transmissions Experiments.	7.5.1- General Strength of Materials			
	•MECA4	Dynamics Experiments.	-EEFC	Computer Controlled Fatigue Testing Unit.	18	
	•MECA5	Friction Experiments.	-EEF	Fatigue Testing Unit.		
	•MECA6	Special Mechanisms Experiments.	-EEU/20KN	Universal Material Testing Unit.	18	
	Software		-EEFCR	Creep Testing Unit.	19	
-CAI	Computer Aided Instruction Software System,		-EEICI	Charpy and Izod Impact Testing Unit.	19	
	additional and optional to the Modules type "MECA".		-EEDB	Brinell Hardness Testing Unit.	20	
-LIMEBA/CAL	Computer Aided Learning Software (Result		-MVV	Unsymmetrical Cantilever Unit.	20	
	Calculation and Analysis), additional and optional to the		-MUP	Loading of Struts Unit.	20	
	Modules type "MECA".		-MTP	Twist & Bend Machine.	21	
7.2- General Mechanics			-MFV	Beam Deflection Unit.	21	
7.2.1- Automotive Mechanisms			-MTB	Torsion Unit.	21	
-MFT	Drum Brake System.	10	-MFLT	Strut Unit.	22	
-MEM	Plate Clutch.	10	-MVS	Suspension Bridge Unit.	22	
-MFD	Disk Brake.	10	-MFL	Two Pinned Arch Unit.	22	
-MCC	Gearbox.	10	-MPO	Portal Frame Unit.	23	
-MDC	Differential- Crownwheel and Pinion.	11	-MDB	Deflection of Curved Bars Unit.	23	
-MFF	Braking and Accelerating Forces Unit.	11	-MMF	Shear Force and Bending Momentum Unit.	23	
-MGE	Gear Generation Unit.		-MVL	Free Vibration Unit.	24	
7.2.2- Gears and Transmissions			-MVLf	Free & Forced Vibration Unit.	24	
-MEC	Overdrive Unit.	11	-MOT	Torsional Oscillations Unit.	24	
-MEE	Geared Lifting Machine.	11	-MAE	Acceleration of Geared Systems Unit.	24	
-MBW	Borg-Warner Automatic Transmission.	12	-MES	Simple Balancing Unit.	25	
-MED	Static & Dynamic Balancing Unit.	12	-MBU	Universal Bench Mounted Frame.	25	
-MTE1	Epicyclic Gear Unit (1 element).	12	-MCD	Thin Cylinder Unit.	25	
-MTE2	Epicyclic Gear Unit (2 elements).	13	7.5.2- Strength of Materials (Photoelasticity)			
-MTE3	Epicyclic Gear Unit (3 elements).	13	-EFO	Photoelasticity Unit.	26	
7.2.3- Mechanisms			-EFOC	Photoelasticity Unit with Strain Gauges Measurement System.	27	
-MSH	Simple Hydraulic System.	13	-EFOV	Photoelasticity Unit with Strain Gauges Measurement System and Artificial Vision System.	28	
-MBD	Slider Crank Mechanism.	14	7.6- Basic Cut Away Mechanics			
-MYE	Scotch Yoke Mechanism.	14	7.7- General Cut Away Mechanics			
-MBM1	Slotted Link Mechanism.	14	7.8- Building			
-MBM2	Whitworth Quick Return Mechanism.	14	-TIAC	Computer Controlled Acoustic Impedance Tube/ Acoustic Insulation Test Unit.	29	
-MCA	Chain Mechanism.	14	-TDRC	Computer Controlled Noise Control Demonstration Unit.	29	
-MME	Geneva Stop Mechanism.	15	-TEVC	Computer Controlled Ventilation Trainer.	30	
-MAC	Coupling Mechanism.	15	-TCMC	Computer Controlled Thermal Conductivity of Building and Insulating Materials Unit.	30	
-MUN	Hook 's Joint Mechanism.	15	7.9- Civil Engineering			
-MEX	Cam and Follower Mechanism.	15	7.10- Agricultural Engineering			
-MUV	Constant Velocity Joint Mechanism.		7.11- Other Engineerings			
-MBI	Crank Mechanism.	16				
7.2.4- Lubrication. Wear. Friction						
-MCF	Belt Friction Unit.	16				
-MEF	Friction Study Unit.	16				
7.3- Automotive						
7.3.1- Sensors and Basic Electricity of Automobile						
7.3.2- Electricity and Electronics of Automobile						
7.3.3- Motors						
7.3.4- Injection Systems						
7.3.5- General Automobile Mechanics						

LIMEBA. **Basic Mechanics Integrated Laboratory:**

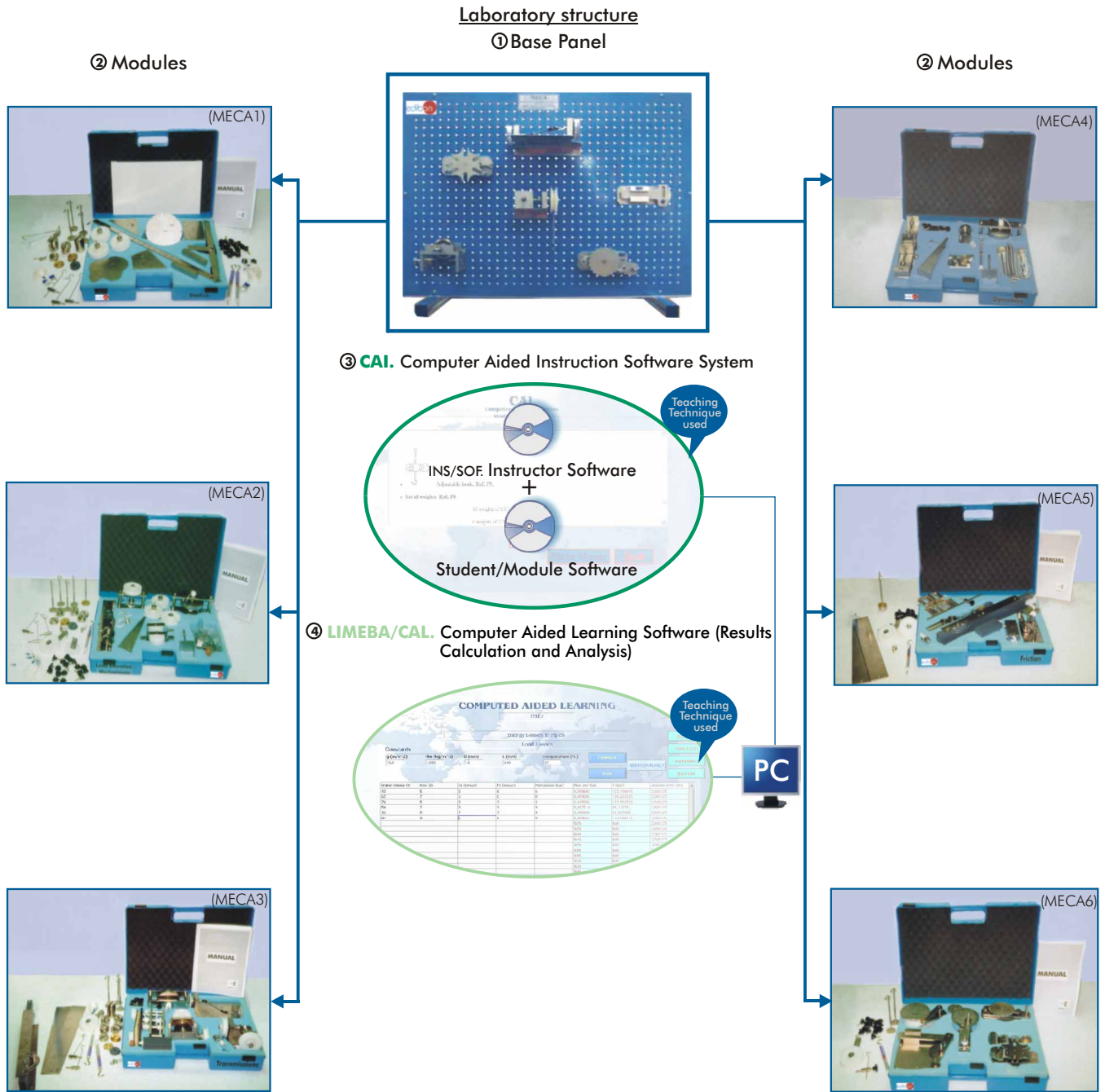

The complete laboratory includes parts 1 to 4 but any part can be supplied individually or additionally to others. (Base Panel + Module/s is the minimum supply).

Some Available Modules:

- MECA1. **Statics Experiments.**
- MECA2. **Load Elevation Mechanisms Experiments.**
- MECA3. **Transmissions Experiments.**
- MECA4. **Dynamics Experiments.**
- MECA5. **Friction Experiments.**
- MECA6. **Special Mechanisms Experiments.**

LIMEBA consists on a complete set of exercises and practical experiments belonging to the area of Applied Mechanics in its two main subareas: Statics (the analysis of structures in balance) and Dynamics (analysis of the motion of mechanisms). LIMEBA is divided into various experimental modules, each one presenting a subject of Statics or Dynamics.

Students are expected to build the experiments on the base panel, where distance measurements are possible due to equidistant spacings between holes on the base panel.

Thanks to the Manuals and the necessary theoretical knowledge imparted by the teacher, students shall be able to do all the measurements.

The MECA series is split up into six parts, named Modules, each of which contains the elements needed for completing a specific group of related exercises and experiments.

More information in: www.edibon.com/products/catalogues/en/units/mechanicsmaterials/basic/LIMEBA.pdf

① Base Panel

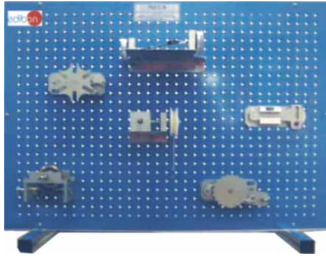

SPECIFICATIONS SUMMARY

It is the supporting structure where the modules's elements are mounted in order to undertake the experiments and hence, the base panel is necessary along with any module.
The panel is pierced with equidistant holes that help students to take measurements.
Anodized aluminium structure.
Front Panel in painted steel.
The holes on the base panel are accurately spaced at 25mm centres.
Dimensions (approx.): 950 x 400 x 550 mm. Weight: 15Kg.

More information in: www.edibon.com/products/catalogues/en/units/mechanicsmaterials/basic/LIMEBA.pdf

② Modules

Each module is formed by different experiment components and is packed in a high quality case. The experimental elements of each module are made out of special anodized aluminium, a high quality material to achieve total precision and to obtain 100% accuracy in carried out practices.

Manuals include laboratory sheets for every experiment, listing the elements needed in every experiment and giving the correct position of each element on the base panel. These sheets also give valuable guidance on how to conduct the experiments and recording the results. There is a particular manual for each Module (8 manuals normally supplied).

MECA1. Statics Experiments

SPECIFICATIONS SUMMARY

All experiment elements are made in special anodized aluminium.
Centres of gravity of various shaped plates: rectangle, circle, triangle, T, kite and irregular.
Drawing panel.
3 Cords and ring. 5 Cords and ring.
Beam balance. Beam.
2 forces equality divided.
The simple pendulum.
Pivot screw. Adjustable hooks.
Set of weights of 0.05 N., 0.1 N., 0.5 N., 1 N., 2 N., 5 N.
Weight hooks. Light weight hooks.
Pulleys. Screws. Knurled nuts.
Large ext. spring. Small ext. spring.
Dynamometer. Spare rope.
Dimensions (approx.): 500 x 360 x 120 mm.
Weight: 5 Kg.

More information in: www.edibon.com/products/catalogues/en/units/mechanicsmaterials/basic/LIMEBA.pdf



PRACTICAL POSSIBILITIES

- Centres of gravity (Centres of gravity (I) and Centres of gravity (II)): Specification of the centre of gravity of plates of different shapes using the simple pendulum and graphical methods.
- Triangle of forces. To test that three non-parallel forces in equilibrium acting in the same plane can be represented by a Triangle of forces.
- Parallelogram of forces. When three non-parallel forces in the same plane are in equilibrium, their lines of action meet at a point, and hence to show that the resultant of two forces can be found using the Parallelogram of forces.
- Polygon of forces. Verification of the fact that four or more forces in equilibrium acting on the same point, can be represented by a Polygon of forces.
- Principle of moments. Verification of the principle of moments for parallel and non parallel forces.
- The Pivot or beam balance. To demonstrate that the action of weighing with a beam balance or slide balance is based upon the principle of moments.
- Levers: To determine the mechanical advantage of various types of levers using the ratio resistance/power (W/P) and to verify that this is the same as the ratio between distances.
- Beam reaction forces. Verification of the fact that a distributed load applied over a beam may be considered as an equivalent concentrated load applied at the centre of gravity of the distributed load. Reactions located at supports due to the load acting on the simply supported beam may be calculated using the momentum principle, independent of the position of these beam supports.

MECA2. Load Elevation Mechanisms Experiments

SPECIFICATIONS SUMMARY

All experiment elements are made in special anodized aluminium.
Three pulley block. Two pulley block. Wheel and axle set. Weston differential chain block.
Screw jack. Support screw. Adjustable hooks.
Set of weights of 0.05 N., 0.1 N., 0.5 N., 1 N., 2 N., 5 N.
Weight hooks. Light weight hook. Pulleys.
Adjustable pulley. Single pulley block.
Knurled nuts. Dynamometer. Spare rope.
Screws.
Dimensions (approx.): 500 x 360 x 120 mm.
Weight: 9 Kg.

More information in: www.edibon.com/products/catalogues/en/units/mechanicsmaterials/basic/LIMEBA.pdf



PRACTICAL POSSIBILITIES

- Simple pulleys. Verification of the variation of cable tension in a pulley with the cable's direction as it passes over the pulley. To determine the mechanical advantages of a simple combination of fixed and movable pulleys.
- Pulley blocks. Analysis of the mechanical features of a set of pulley blocks, which has three sheaves in the upper block and two pulleys in the lower block.
- Single axle and wheel. Determine the law of the Machine for a simple axle and wheel, and the variation of mechanical advantage and efficiency with load.
- Differential axle and wheel. Determine the law of the Machine for differential axle and wheel. Verification that the mechanical advantage and efficiency increases with load up to a limiting maximum.
- Weston differential chain blocks. Analysis of the specific characteristics of these chains.
- Screw Jack. To measure the effort required to raise various loads using a simple form of screw jack and to determine how the mechanical advantage and efficiency varies with load.

MECA3. Transmissions Experiments

SPECIFICATIONS SUMMARY

All experiment elements are made in special anodized aluminium.
System of belt drive (includes: flat belt, round belt and leather strip). Chain drive. Simple gear train. Bevel gears. Worm gears.
Universal coupling. Support screw.
Adjustable screws.
Set of weights of 0.05 N., 0.1 N., 0.5 N., 1 N., 2 N., 5 N.
Weight hooks. Light weight hooks. Pulley.
Screws. Knurled nuts. Dynamometers. Spare rope.
Dimensions (approx.): 500 x 360 x 120 mm.
Weight: 7 Kg.

More information in: www.edibon.com/products/catalogues/en/units/mechanicsmaterials/basic/LIMEBA.pdf



PRACTICAL POSSIBILITIES

- Belt drive (Belt drive (I) and Belt drive (II)): Verification of the direction of rotation of open and crossed belt drives. Verification of the speed of rotation of the two pulleys is inversely proportional to their diameters. To measure the difference in tension between the two sides of a belt drive and to determine the efficiency of drive transmission.
- Chain drive. Verification of the speed ratio of a chain drive. Measurement of the efficiency of drive transmission.
- The Geared winch (two parallel axes). Comparison of the velocity ratios of a system of single-stage and double stage geared winch. Specification of their corresponding mechanical advantages and efficiencies under varying loads.
- Bevel gears (two intersecting axes). Verification of the efficiency velocity-ratio and mechanical advantages of the Bevel gear unit under different loads.
- Worm gear (two crossed axes). Verification of the speed ratio of a worm and specification of the transmission efficiency under different loads.
- Universal coupling. To investigate the effect of introducing universal coupling to a simple drive shaft.

LIMEBA. Basic Mechanics Integrated Laboratory:

② Modules

MECA4. Dynamics Experiments



SPECIFICATIONS SUMMARY

All experiment elements are made in special anodized aluminium.
 The spring balance.
 Friction with rear.
 Friction equipment.
 Wheel.
 Centrifugal force system.
 The simple pendulum.
 Adjustable screw.
 Set of weights of 0.05 N., 0.1 N., 0.5 N., 1 N., 2 N., 5 N.
 Weight hooks.
 Adjustable pulley.
 Screws.
 Knurled nuts.
 Small ext. Spring.
 Large ext. Spring.
 Dynamometer.
 Spare rope.
 Dimensions (approx.): 500 x 360 x 120 mm.
 Weight: 7 Kg.

More information in:

www.edibon.com/products/catalogues/en/units/mechanicsmaterials/basic/LIMEBA.pdf

PRACTICAL POSSIBILITIES

- 1.- Spring balance. To verify that the extension of a coiled spring is proportional to the load applied, to show the principle of a spring balance.
- 2.- Simple pendulum. To show that the time of a simple pendulum depends only on the length of the pendulum, and to determine the value of the force of gravity using a simple pendulum.
- 3.- Kinetic and potential energy. Analysis of some features of kinetic and potential energy and to show that energy exists, that is may be transformed, and that it may be "stored" and "given back".
- 4.- Inertia. The wheel. To find the energy stores in a wheel by supplying a known quantity of energy.
- 5.- Belt-pulley friction. Verification of the fact that the driving force of a transmission belt increases with the helical angle.
- 6.- Centrifugal force. Demonstration of the laws of the centrifugal force.

MECA5. Friction Experiments



SPECIFICATIONS SUMMARY

All experiment elements are made in special and anodized aluminium.
 Friction equipment.
 Friction with roar.
 Foils of friction.
 Roller.
 Block of wheels with roar.
 Set of rollers in a marc.
 Principle of wedge.
 Bearings.
 The simple pendulum.
 Set of weights of 0.05 N., 0.1 N., 0.5 N., 1 N., 2 N., 5 N.
 Weight hooks.
 Light weight hook.
 Pulley.
 Adjustable pulley.
 Single pulley block.
 Screws. Knurled nuts.
 Dynamometer.
 Spare rope.
 Dimensions (approx.): 500 x 360 x 120 mm.
 Weight: 6 Kg.

More information in:

www.edibon.com/products/catalogues/en/units/mechanicsmaterials/basic/LIMEBA.pdf

PRACTICAL POSSIBILITIES

- 1.- Sliding friction. Verification of the laws of friction and to measure the coefficient of friction for different materials.
- 2.- Inclined plane (Inclined plane (I) and Inclined plane (II)) Analysis of the forces acting on an inclined plane due to a weighted of a roller supported on the plane. Calculation of the starting force needed for dragging a block on the plane.
- 3.- Angle of friction. Measurement of the angle of friction and from it find the coefficient of friction. To show that the coefficient of friction is equal to tangent of the angle of friction.
- 4.- Friction. To show the extent to which friction is reduced by using wheels and rollers and to compare the effects of different bearing surfaces.
- 5.- The wedge. Determine mechanical advantage and efficiency obtained using two different wedges, and to show that overhauling may be prevented if the angle of inclination of a wedge is small.
- 6.- Bearings. Comparison of the resistance to turning due to friction of four bearings made of different materials, and to show something of the progress made in bearing development.

MECA6. Special Mechanisms Experiments



SPECIFICATIONS SUMMARY

All experiment elements are made in special and anodized aluminium
 The cam and roller mechanisms (included two cams).
 Geneva mechanism.
 The ratchet mechanisms.
 Scotch yoke.
 Crank mechanism.
 Quick return mechanism.
 Adjustable hooks.
 Set of weights of 0.05 N., 0.1 N., 0.5 N., 1 N., 2 N., 5 N.
 Weight hooks.
 Adjustable pulley.
 Screws.
 Knurled nuts.
 Dynamometer.
 Dimensions (approx.): 500 x 360 x 120 mm. Weight: 7 Kg.

More information in:

www.edibon.com/products/catalogues/en/units/mechanicsmaterials/basic/LIMEBA.pdf

PRACTICAL POSSIBILITIES

- 1.- Cam and roller. To study the difference aspects of cam design.
- 2.- Geneva motion. Verification of how the circular motion of the drive unit is transformed into the intermittent motion of the Geneva motion, and of how this mechanism accelerates and decelerates during the transmission process.
- 3.- Ratchet mechanisms. Examination of the parts of the Ratchet assembly supplied in which a swinging lever is fitted with two pawls.
- 4.- Scotch yoke. Analysis and verification of the motion of a driving crank and its relation to the reciprocal element of motion.
- 5.- Crank mechanism. Analysis of the features of a crank mechanism, drawing a rotation torque diagram and educing the relation between the crank rotation and the slide platform movement.
- 6.- Quick return mechanism. To show a quick return mechanism at work and to record the relationship between the rotation of the crank and the movement of the slide.

③ CAI. Computer Aided Instruction Software System

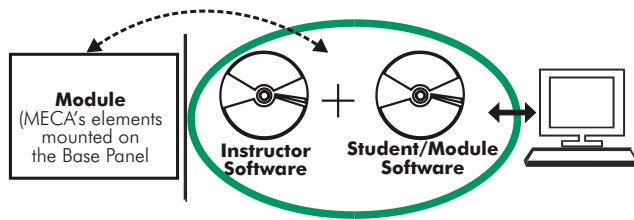

With no physical connection between module and computer, this complete package consists on an Instructor Software (INS/SOF) totally integrated with the Student/Module Software (MECA../SOF). Both are interconnected so that the teacher knows at any moment what is the theoretical and practical knowledge of the students. These, on the other hand, get a virtual instructor who helps them to deal with all the information on the subject of study.

- INS/SOF. Classroom Management Software (Instructor Software):

The Instructor can:

- Organize Students by Classes and Groups.
- Create easily new entries or delete them.
- Create data bases with student information.
- Analyze results and make statistical comparisons.
- Print reports.
- Develop own examinations.
- Detect student's progress and difficulties.
- ...and many other facilities.

The Instructor Software is the same for all the modules, and working in network configuration allows controlling all the students in the classroom.

- MECA../SOF. Computer Aided Instruction Softwares (Student/Module Software):

It explains how to use the module, run the experiments and what to do at any moment. Each module has its own Student Software:

- The options are presented by pull-down menus and pop-up windows.
- This Software contains:

Theory: that gives the student the theoretical background for a total understanding of the studied subject.

Exercises: divided by thematic areas and chapters to check out that the theory has been understood.

Guided Practices: presents several practices to be done with the module, showing how to complete the exercises and practices.

Exams: set of questions presented to test the obtained knowledge.

Instructor Software

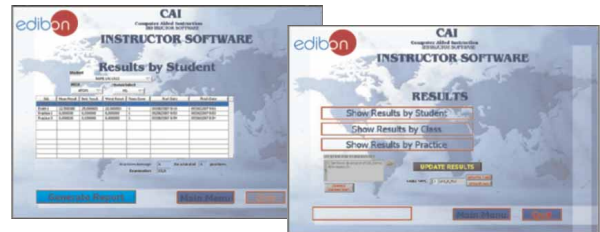

Student/Module Software



Available Student/Module Softwares:

- MECA1/SOF. Statics.
- MECA2/SOF. Load Elevation Mechanisms.
- MECA3/SOF. Transmissions.
- MECA4/SOF. Dynamics.
- MECA5/SOF. Friction.
- MECA6/SOF. Special Mechanisms.

④ LIMEBA/CAL. Computer Aided Learning Software (Results Calculation and Analysis)

This Computer Aided Learning Software (CAL) is a Windows based software, simple and very easy to use, specifically developed by EDIBON.

CAL is a class assistant that helps in making the necessary calculations to extract the right conclusions from data obtained during the experimental practices.

CAL will perform the calculations.

CAL computes the value of all the variables involved.

It allows to plot and print the results. Between the plotting options, any variable can be represented against any other.

Different plotting displays.

It has a wide range of information, such as constant values, unit conversion factors and integral and derivative tables.

Calculations

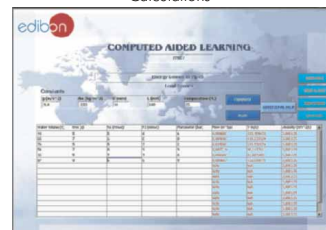

Information of constant values, unit conversion factors and integral and derivative tables

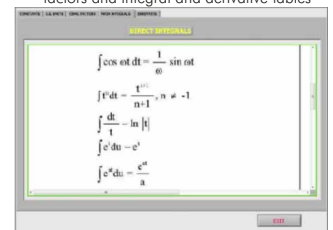

Plotting options



Available Softwares:

- MECA1/CAL. Statics.
- MECA2/CAL. Load Elevation Mechanisms.
- MECA3/CAL. Transmissions.
- MECA4/CAL. Dynamics.
- MECA5/CAL. Friction.
- MECA6/CAL. Special Mechanisms.

7.2.1- Automotive Mechanisms

MFT. Drum Brake System



SPECIFICATIONS SUMMARY

The Drum Brake System (MFT) is particularly suitable for motor vehicle teaching. The unit permits to demonstrate the difference in the braking torque between leading and trailing shoe braking systems and the effect on the braking torque of the different combinations of leading and trailing shoes.

With this unit we can carry out studies and experiments to investigate the relationship between actuating forces and the braking torques and for the determination of the coefficient of friction between the brake lining and the drum.

To have drum torque and braking load applied by weights hangers and cord.

Two shoes with brake linings are provided.

Manuals: This unit is supplied with 8 manuals.

Dimensions (approx.): 455 x 270 x 300 mm. Weight: 15 Kg.

More information in: www.edibon.com/products/catalogues/en/units/mechanicsmaterials/general/MFT.pdf

PRACTICAL POSSIBILITIES

- 1.- Demonstration of a drum brake with leading and trailing shoes.
- 2.- Demonstration of the effect on the braking torque of different combinations of leading and trailing shoes.
- 3.- To study the difference in the braking torque between leading and trailing shoe braking systems.
- 4.- To determine experimentally the variation of tangential force with braking load.
- 5.- To investigate the relationship between actuating forces and the braking forces.
- 6.- Determination of the coefficient of friction between the drum and the brake shoe.
- 7.- With the optional accessory MFTA the student can investigate the effect on the braking torque when the pressure point on the brake shoe is displaced relative to the pivot point.

MEM. Plate Clutch



SPECIFICATIONS SUMMARY

This unit has been designed to perform studies and experiments on surface friction and the function of a plate clutch.

We can also carry out experiments to investigate the relationship between the pressure applied to the friction surfaces, the radius of the friction discs and the torque.

This unit is mounted on a aluminium and painted steel structure.

The unit comprises a lower plate and an upper plate. On top of the lower plate sits the upper plate whose shaft rotates in ball bearings.

Between the lower and upper plates will be the interchangeable friction discs. Three interchangeable discs of different diameters are supplied.

The self weight of the upper plate is the minimum pressure or force on the friction disc. Adding weights to the upper plate we can increase the contact pressure.

Torque is applied to the upper plate through pulleys and loaded cords. By means of hangers and masses or weights we can modify the loading force and also adjust the torque.

This unit can be wall mounted.

Manuals: This unit is supplied with 8 manuals.

Dimensions (approx.): 400 x 300 x 400 mm. Weight: 15 Kg.

More information in: www.edibon.com/products/catalogues/en/units/mechanicsmaterials/general/MEM.pdf

PRACTICAL POSSIBILITIES

- 1.- Function of a plate clutch.
- 2.- Relationship between contact force and friction moment.
- 3.- To determine the coefficient of friction.
- 4.- To study the influence of the materials used on the friction moment.
- 5.- To study the influence of the friction surface geometry on the friction moment.
- 6.- To investigate the relationship between the pressure applied to the friction surfaces, the radius of the friction surfaces, the number of friction surfaces and the torque.
- 7.- To show that the minimum torque to maintain rotation is proportional to the axial load and diameter of the friction surface.

MFD. Disk Brake



SPECIFICATIONS SUMMARY

This unit (MFD) has been designed to carry out experiments to investigate the relationship between the normal force acting on the brake pads, the effective radius of the brake pads and the braking torque.

The brake pads are located on bell crank levers to which the load hangers may be attached. A load beam is supplied for use when carrying out experiments with two brake pads. The support shafts are drilled and pins provided so that the bell crank levers can be located in different radial positions.

Different brake pads materials can be tested.

The braking torque can be determined by attaching masses or weights to a cord wrapped round the pulley on the disc shaft.

This unit may be wall mounted.

Manuals: This unit is supplied with 8 manuals.

Dimension (approx.): 400 x 350 x 350 mm. Weight: 15 Kg.

More information in: www.edibon.com/products/catalogues/en/units/mechanicsmaterials/general/MFD.pdf

PRACTICAL POSSIBILITIES

With this unit we can study and carry out experiments to investigate:

- 1.- Normal forces.
- 2.- Friction.
- 3.- Effective radius of the brake pads.
- 4.- Normal force acting on the brake pads.
- 5.- Determination of the braking torque.
- 6.- Material suitability testing.

MCC. Gearbox



SPECIFICATIONS SUMMARY

The gearbox (MCC) has been designed to represent a typical arrangement of a simple three forward ratio and reverse sliding mesh box.

Basically the gearbox unit consists on gear wheels of different sizes. These can be engaged as required.

The gears are clearly visible to aid the students understanding of the principles involved. All gears run on shafts fitted into bearings and the changing mechanism ensures smooth transition.

Pulleys fitted with protractors are attached to the input and output shafts so that students can determine and verify velocity and torque ratios.

This unit may be wall mounted.

In order to carry out some of the practices with MCC unit, 2 Sets of weights "B type" are required.

Manuals: This unit is supplied with 8 manuals.

Dimensions (approx.): 530 x 350 x 530 mm. Weight: 17 Kg.

More information in: www.edibon.com/products/catalogues/en/units/mechanicsmaterials/general/MCC.pdf

PRACTICAL POSSIBILITIES

- 1.- Measure of the angular displacement at the input and output of the gear box and comparison with the calculated values.
- 2.- Calculation of the efficiency for different ratios according to the torque at entry.
- 3.- Determination of velocity and torque ratios.
- 4.- Measurement of input and output angular displacements and comparing with the theoretical ratios.
- 5.- Efficiency studies.

7.2- General Mechanics

7.2.1- Automotive Mechanisms

MDC. Differential-Crownwheel and Pinion

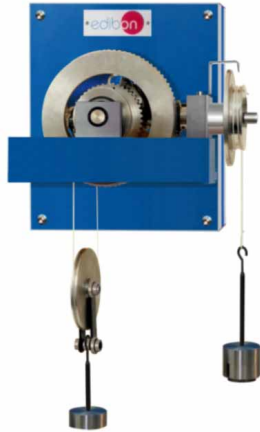

SPECIFICATIONS SUMMARY

The Differential-Crownwheel and Pinion Unit (MDC) has been designed to demonstrate the action of Crownwheel and pinion rear axle drive and differential gear elements.

A pulley fitted with a protractor is located at the input shaft. The output bevels are grooved and can be loaded individually or by means of a differential pulley arrangement so that we can determine and verify torque distribution and velocity ratios.

In order to carry out some of the practices with MDC unit, 2 Sets of weights "B type" are required.

This unit can be wall mounted.

Manuals: This unit is supplied with 8 manuals.

Dimensions (approx.): 400 x 350 x 500 mm. Weight: 20 Kg.

More information in: www.edibon.com/products/catalogues/en/units/mechanicsmaterials/general/MDC.pdf

PRACTICAL POSSIBILITIES

- 1.- Determining the input and output velocity ratios and torque distribution.
- 2.- Efficiency studies.
- 3.- Study of the use of a differential as a simple transmission system.
- 4.- To visualise and demonstrate the action of a differential when used as a means of providing a drive.

MFF. Braking and Accelerating Forces Unit

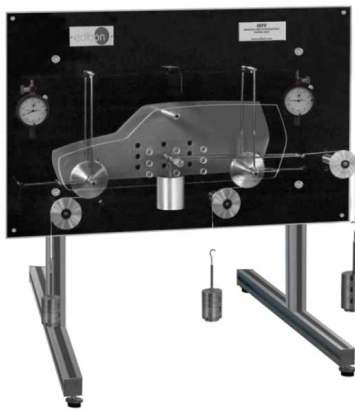

SPECIFICATIONS SUMMARY

A load transfer between front and rear wheels takes place under conditions of braking or acceleration of a vehicle (a car for example). The problem of load transfer occurs since the accelerating or braking force is not applied to the centre of gravity of the vehicle but to the point of contact of the wheels with the road.

The MFF unit has been designed to demonstrate and study this load transfer.

This unit allows to carry out practices and experiments to study the relationship between the forces involved in car braking and acceleration.

The MFF unit also allows the demonstration of the relationship between these forces on front wheel drive, rear wheel drive, and four wheel drive.

This unit is mounted on an anodized aluminium and steel structure. A car model is supported on a beam load cell and has road wheels. A pin can be inserted in different positions to represent the centre of gravity of the car.

Pulleys, weights and cords are used to apply different horizontal braking or acceleration and inertia forces to the car.

Manuals: This unit is supplied with 8 manuals.

Dimensions (approx.): 800 x 600 x 800 mm. Weight: 20 Kg.

More information in: www.edibon.com/products/catalogues/en/units/mechanicsmaterials/general/MFF.pdf

PRACTICAL POSSIBILITIES

- 1.- Investigation of the relationship between the forces involved in vehicle braking and acceleration.
- 2.- Study of the inertia force.
- 3.- Demonstration of the relationship between these forces on front wheel drive, rear wheel drive, and four wheel drive.
- 4.- Study of the load transfer between front and rear wheels.
- 5.- Study of different conditions varying the position of the centre of gravity.
- 6.- Application of the accelerating or braking force on different points of the centre of gravity.

7.2.2- Gears and Transmissions

MEC. Overdrive Unit

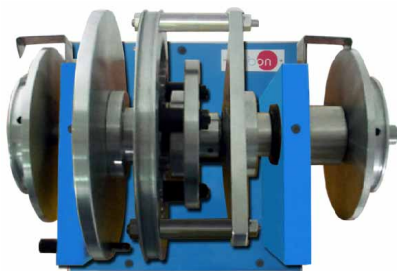

SPECIFICATIONS SUMMARY

Overdrive Unit (MEC) has been designed to demonstrate the action of the gear elements in simple epicyclic gear arrangements. The unit may also be used to carry out experiments on epicyclic gearing.

This unit represents an application of a simple epicyclic arrangement of the type used in a motor vehicle overdrive.

Pulleys fitted with protractors are secured to the input and output shafts to enable us to determine and verify velocity and torque ratios.

The MEC unit is assembled in a metallic structure and can be wall mounted.

In order to carry out some of the practices with MEC unit, 2 Sets of weights "B type" are required.

Manuals: This unit is supplied with 8 manuals.

Dimensions (approx.): 400 x 350 x 410 mm. Weight: 15 Kg.

More information in: www.edibon.com/products/catalogues/en/units/mechanicsmaterials/general/MEC.pdf

PRACTICAL POSSIBILITIES

- 1.- Study of a simple lifting mechanism and its use to determine the velocity ratio, mechanical advantages and efficiency.
- 2.- Use of pulleys and gears to simulate simple wheel and shaft, single gear and double gear.
- 3.- Measurement of the linear displacement between the masses and comparison with the calculated values.
- 4.- Calculation of the minimum work to lift a load and the efficiency.

MEE. Geared Lifting Machine



SPECIFICATIONS SUMMARY

This unit has been designed to study a simple lifting mechanism and its use to determine the velocity ratio, mechanical advantages and efficiency.

This unit is mounted on a metallic structure and may be wall mounted.

In order to carry out some of the practices with MEE unit, 2 Sets of weights "B type" are required.

Manuals: This unit is supplied with 8 manuals.

More information in: www.edibon.com/products/catalogues/en/units/mechanicsmaterials/general/MEE.pdf

7.2.2- Gears and Transmissions

MBW. Borg-Warner Automatic Transmission



SPECIFICATIONS SUMMARY

The MBW unit simulates the working of all the elements that compose an automatic transmission and it lets the student learn its working, being able to proceed to its diagnosis and study the consequences of a fault in a clutch or in band brakes.

This unit is mainly composed of:

Planetary gear set formed for:

- 2 sun gears, one for forward operations and the other one for reverse operations.
- 2 set of pinions: long and short pinions.
- A common carrier for the pinions.
- A ring gear.

2 graduated discs placed in the input and output shaft.

2 input discs to simulate the clutch of gears.

Some mechanic actuators or pins that simulate the pilot valves used to brake the different components of the planetary gear.

The shaft of the unit is made of stainless steel. The discs and the gears are made of aluminum to facilitate the practice's carrying out.

MBW is a bench-top unit supported by four legs. Besides, it is provided with four brackets to be suspended in the wall, which allows an easier carrying out of the practice with weights.

Manuals: This unit is supplied with 8 manuals.

Dimensions (approx.): 450 x 320 x 300 mm. Weight: 15 Kg.

More information in: www.edibon.com/products/catalogues/en/units/mechanicsmaterials/general/MBW.pdf

PRACTICAL POSSIBILITIES

Selection of the gears:

- 1.- First gear (lockup selected).
- 2.- First gear imposed (drive selected).
- 3.- Second gear.
- 4.- Third gear.
- 5.- Reverse gear.
- 6.- Neutral position.
- 7.- Parking break.

Faults simulation:

- 8.- Forward gear clutch fault.
- 9.- Reversing gear clutch fault.
- 10.- Brakes fault.

Power transmission:

- 11.- Checking the connection between the torque motor of the input and the torque motor of the output.
- 12.- Experiment for the different connections of reduction but activating the motor brake of the transmission.

MED. Static & Dynamic Balancing Unit



SPECIFICATIONS SUMMARY

The Static and Dynamic Balancing Unit developed by EDIBON is an unit to study and analyze the oscillations and vibrations and how to eliminate or diminish them.

This unit has:

An electrical motor with variable speed which can reach 8,300 r.p.m.

It has a transmission through pulleys and a belt from the motor to the shaft.

2 Balancing discs. They are made of aluminum and have a diameter of 150 mm.

An aluminum external disc, that we will name Graduated disc. It has a diameter of 150 mm.

The unit is completed with a set of sector masses and weights to do the practices:

- 2 Sector masses of 27° angle. 2 Sector masses of 114° angle.
- 2 Sector masses of 43° angle. 2 Sector masses of 72° angle.

18 weights of 60 gr., 40 gr., 30 gr., 20 gr. and 15 gr., to do the balance of masses in rotation experiments.

Auxiliary module for the electrical supply and the motor control. At its back, there are connections and at its front part it has a potentiometer to control the speed of the motor.

Cables and Accessories, for normal operation.

Manuals: This unit is supplied with 8 manuals.

Dimensions (approx.):

Unit: 450 x 550 x 600 mm. Weight: 30 Kg

Auxiliary module: 310 x 220 x 145 mm. Weight: 2 Kg

More information in: www.edibon.com/products/catalogues/en/units/mechanicsmaterials/general/MED.pdf

PRACTICAL POSSIBILITIES

- 1.- Balance on an individual plane of revolution.
- 2.- Balance on separated planes of revolution.
- 3.- Easy demonstration experiments.
- 4.- Illustrate the dynamic balance of rotation and reciprocating systems.
- 5.- Balance of reciprocating masses.
- 6.- Observe the effects on oscillations of various conditions of partial balance in the reciprocating systems.

MTE1. Epicyclic Gear Unit (1 element)

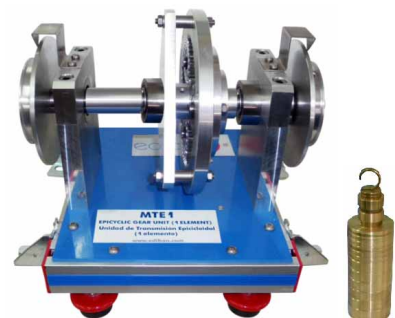

SPECIFICATIONS SUMMARY

The epicyclic gear unit (MTE1) has been developed to enable students carry out studies and investigations concerning epicyclic gearing.

This unit is mainly composed of:

Coupled epicyclic gears set, formed by:

- Sun gears.
- Satellite gears set.
- Common support of the satellites.
- External ring.

2 Graduated discs located at the input and output shafts.

The shafts of the unit are made in stainless steel. The discs and gears are made in aluminium to facilitate the experiments.

The pinions are mounted on ball bearings to reduce frictional losses. They are made in aluminium, so the inertia will be less and the results of the experiments will be improved.

MTE1 is a bench-top unit supported by four legs. Besides, it is provided with four brackets to be suspended in the wall, which allows the experiments with weights to be carried out more easily.

Manuals: This unit is supplied with 8 manuals.

Dimensions (approx.): 300 x 300 x 300 mm. Weight: 19 Kg

More information in: www.edibon.com/products/catalogues/en/units/mechanicsmaterials/general/MTE1.pdf

PRACTICAL POSSIBILITIES

- 1.- Demonstration of the function of an epicyclic gear system.
- 2.- To determine and verify the velocity and torque ratios between the input and output shafts.
- 3.- Study of the mechanical advantage and efficiency of a planetary system.
- 4.- Determination of the angular displacement at the input and output and comparison with calculated ratios.
- 5.- Determination of the minimum force at the input to move a weight at the output.
- 6.- Overdrive.
- 7.- Direct drive.

7.2.2- Gears and Transmissions

MTE2. Epicyclic Gear Unit (2 elements)



SPECIFICATIONS SUMMARY

EDIBON "MTE2" transmission consists of two coupled epicyclic gears sets. It will allow the students to carry out experiments of different gear ratios, as well as the torque conversions.

This unit is mainly composed of:

2 Coupled epicyclic gear sets, formed by:

- Sun gears.
- Satellite gears set.
- Common support of the satellites.
- External ring.

2 Graduated discs located at the input and output shafts.

Different mechanical pins that simulate the pilot valves used to brake the different planetary components.

The shafts of the unit are made in stainless steel. The discs and gears are made in aluminium to facilitate the experiments.

The pinions are mounted on ball bearings to reduce frictional losses. They are made in aluminium, so the inertia will be less and the results of the experiments will be improved.

The MTE2 unit provides three forward speeds.

MTE2 is a bench-top unit supported by four legs. Besides, it is provided with four brackets to be suspended in the wall, which allows the experiments with weights to be carried out more easily.

Manuals: This unit is supplied with 8 manuals.

Dimensions (approx.): 360 x 260 x 300 mm. Weight: 24 Kg

More information in: www.edibon.com/products/catalogues/en/units/mechanicsmaterials/general/MTE2.pdf

PRACTICAL POSSIBILITIES

- 1.- Demonstration of the function of an epicyclic gear system.
- 2.- To determine and verify the velocity and torque ratios between the input and output shafts.
- 3.- Study of the mechanical advantage and efficiency of a planetary system.
- 4.- Determination of the angular displacement at the input and output and comparison with calculated ratios.
- 5.- Determination of the minimum force at the input to move a weight at the output.

Gears selection:

- 6.- First gear.
- 7.- Second gear.
- 8.- Third gear.
- 9.- Neutral.

Power transmission:

- 10.- Checking the relation between the input motor torque and the output motor torque.

MTE3. Epicyclic Gear Unit (3 elements)



SPECIFICATIONS SUMMARY

EDIBON "MTE3" transmission consists of three coupled epicyclic gears sets. It will allow the students to carry out experiments of different gear ratios, as well as the torque conversions.

This unit is mainly composed of:

3 Coupled epicyclic gear sets, formed by:

- Sun gears.
- Satellite gears set.
- Common support of the satellites.
- External ring.

2 Graduated discs located at the input and output shafts.

Different mechanical pins that simulate the pilot valves used to brake the different planetary components.

The shafts of the unit are made in stainless steel. The discs and the gears are made in aluminium to facilitate the experiments.

The pinions are mounted on ball bearings to reduce frictional losses. They are made in aluminium, so the inertia will be less and the results of the experiments will be improved.

The MTE3 unit provides three forward speeds and one reverse speed.

MTE3 is a bench-top unit supported by four legs. Besides, it is provided with four brackets to be suspended in the wall, which allows the experiments with weights to be carried out more easily.

Manuals: This unit is supplied with 8 manuals.

Dimensions (approx.): 500 x 260 x 300 mm. Weight: 30 Kg

More information in: www.edibon.com/products/catalogues/en/units/mechanicsmaterials/general/MTE3.pdf

PRACTICAL POSSIBILITIES

- 1.- Demonstration of the function of an epicyclic gear system.
- 2.- To determine and verify the velocity and torque ratios between the input and output shafts.
- 3.- Study of the mechanical advantage and efficiency of a planetary system.
- 4.- Determination of the angular displacement at the input and output and comparison with calculated ratios.
- 5.- Determination of the minimum force at the input to move a weight at the output.

Gears selection:

- 6.- First gear.
- 7.- Second gear.
- 8.- Third gear.
- 9.- Reverse gear.
- 10.- Neutral.

Power transmission:

- 11.- Checking the relation between the input motor torque and the output motor torque.

7.2.3- Mechanisms

MSH. Simple Hydraulic System



SPECIFICATIONS SUMMARY

The MSH has been designed for mechanical engineering and motor vehicle studies. It is used to demonstrate how a liquid can be used to transmit a force.

The unit can also be used to carry out experiments to study the relationships between the force on the plungers, the cross section area of the plungers and the fluid pressure in the system.

This unit is mounted on an anodized aluminium structure and painted steel panel.

The unit consists of three cylinders and plungers whose cross-section areas are in the ratio 1, 2 and 6. These three cylinders and the pressure gauge are connected in parallel. Using the on/off taps included in the circuit any of the cylinder units can be isolated from the system.

Load hangers are supplied.

In order to carry out some of the practices with MSH unit, 2 Sets of weights "B type" are required.

Manuals: This unit is supplied with 8 manuals.

Dimensions (approx.): 710 x 600 x 810 mm. Weight: 25 Kg.

More information in: www.edibon.com/products/catalogues/en/units/mechanicsmaterials/general/MSH.pdf

7.2.3- Mechanisms

MBD. Slider Crank Mechanism



SPECIFICATIONS SUMMARY

Manuals: This unit is supplied with 8 manuals.
Dimensions (approx.): 310 x 150 x 60 mm. Weight: 1.5Kg.

More information in: www.edibon.com/products/catalogues/en/units/mechanicsmaterials/general/MBD.pdf 

MYE. Scotch Yoke Mechanism

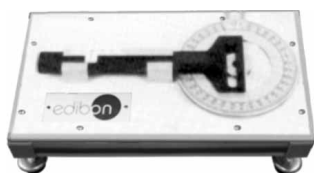

SPECIFICATIONS SUMMARY

Manuals: This unit is supplied with 8 manuals.
Dimensions (approx.): 310 x 150 x 45 mm. Weight: 1.5Kg.

More information in: www.edibon.com/products/catalogues/en/units/mechanicsmaterials/general/MYE.pdf 

MBM1. Slotted Link Mechanism



SPECIFICATIONS SUMMARY

Manuals: This unit is supplied with 8 manuals.
Dimensions (approx.): 400 x 300 x 100 mm. Weight: 3Kg.

More information in: www.edibon.com/products/catalogues/en/units/mechanicsmaterials/general/MBM1.pdf 

MBM2. Whitworth Quick Return Mechanism



SPECIFICATIONS SUMMARY

Manuals: This unit is supplied with 8 manuals.
Dimensions (approx.): 310 x 150 x 60 mm. Weight: 1.5Kg.

More information in: www.edibon.com/products/catalogues/en/units/mechanicsmaterials/general/MBM2.pdf 

MCA. Chain Mechanism



SPECIFICATIONS SUMMARY

Manuals: This unit is supplied with 8 manuals.
Dimensions (approx.): 390 x 260 x 60 mm. Weight: 2Kg.

More information in: www.edibon.com/products/catalogues/en/units/mechanicsmaterials/general/MCA.pdf 

MME. Geneva Stop Mechanism

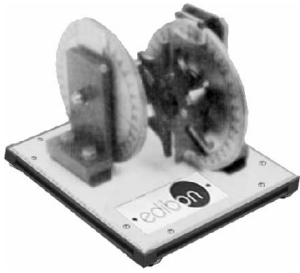

SPECIFICATIONS SUMMARY

Manuals: This unit is supplied with 8 manuals.
Dimensions (approx.): 230 x 150 x 160 mm. Weight: 3Kg.

More information in: www.edibon.com/products/catalogues/en/units/mechanicsmaterials/general/MME.pdf

MAC. Coupling Mechanism

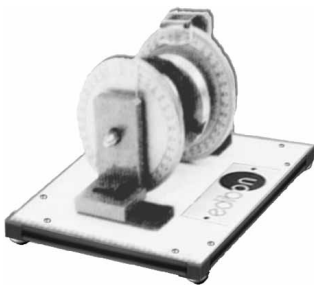

SPECIFICATIONS SUMMARY

Manuals: This unit is supplied with 8 manuals.
Dimensions (approx.): 230 x 150 x 160 mm. Weight: 3Kg.

More information in: www.edibon.com/products/catalogues/en/units/mechanicsmaterials/general/MAC.pdf

MUN. Hook's Joint Mechanism



SPECIFICATIONS SUMMARY

Manuals: This unit is supplied with 8 manuals.
Dimensions (approx.): 300 x 230 x 180 mm. Weight: 5Kg.

More information in: www.edibon.com/products/catalogues/en/units/mechanicsmaterials/general/MUN.pdf

MEX. Cam and Follower Mechanism

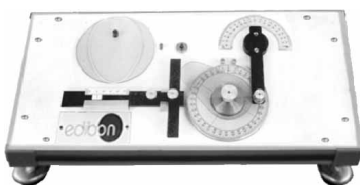

SPECIFICATIONS SUMMARY

Manuals: This unit is supplied with 8 manuals.
Dimensions (approx.): 390 x 230 x 65 mm. Weight: 2Kg.

More information in: www.edibon.com/products/catalogues/en/units/mechanicsmaterials/general/MEX.pdf

7.2.3- Mechanisms

MBI. Crank Mechanism



SPECIFICATIONS SUMMARY

The Crank Mechanism (MBI) is an unit that allows to observe, study and record the crank motion and forces involved with a simple engine mechanism.

This unit is mounted on an aluminium and painted steel structure.

The crank effort can be determined by attaching masses or weights to the beam balance arm.

The piston is fitted with rollers running on guide bars and roller bearings are fitted in the connecting rod.

Attached to the crank there is a protractor which can be rotated on the beam balance arm and locked in any predetermined angular position.

The piston displacement can be measured with the help of a linear scale attached to the piston guide. The piston can be fitted with removable masses or weights to change the piston mass.

This unit may be wall mounted.

Manuals: This unit is supplied with 8 manuals.

Dimensions (approx.): 500 x 300 x 600 mm. Weight: 18 Kg.

More information in: www.edibon.com/products/catalogues/en/units/mechanicsmaterials/general/MBI.pdf

PRACTICAL POSSIBILITIES

- 1.- To investigate the relationship between the piston displacement and the crank angle for a given connecting rod/crank radius ratio.
- 2.- To investigate the relationship between the turning moment on the crank shaft and the crank angle for a given force on the piston.
- 3.- Determination of the crank effort.
- 4.- Balancing the crank shaft.
- 5.- Measurement of the piston displacement.

7.2.4- Lubrication Wear Friction

MCF. Belt Friction Unit



SPECIFICATIONS SUMMARY

The Belt Friction Unit (MCF) allows us to carry out studies and investigations to compare the driving torque for a given degree of overlap of a flat belt (leather or rope) and a 'V' belt.

We can observe the relationship between the tensions in the two sides of a belt, to evaluate the differences between flat (leather or rope) and "V" belts and to investigate the effect of the angle lap, among others.

Tension is introduced into the belt by hanging a mass or weight. The slipping torque is determined by the addition of a suitable mass attached to a cord wrapped round the drum.

The unit is mounted in a metallic structure and basically consists of a pulley, 3 belts and load hangers.

4 pulleys: a flat one and 3 "V" pulleys (one of them is correctly fitted and the others are badly fitted). The angle of overlap can be varied in increments of 10 degrees.

The pulley is balanced and mounted on bearings to reduce frictional losses. It has machined grooves to suit the belts.

Three belts are supplied ("V", leather and rope).

Set of weights.

Manuals: This unit is supplied with 8 manuals.

Dimension (approx.): 550 x 500 x 600 mm. Weight: 15 Kg.

More information in: www.edibon.com/products/catalogues/en/units/mechanicsmaterials/general/MCF.pdf

PRACTICAL POSSIBILITIES

- 1.- Investigation of the relationship between the belt tensions and the angle of lap for a flat belt.
 - 2.- Comparison of the driving torque for a given angle of lap.
- Other possible practices:
- 3.- To evaluate the differences between Vee 'V' and flat belts.
 - 4.- To determine the coefficient of friction between the pulley and belt for the belt sections.
 - 5.- To verify the belt tension equation.

MEF. Friction Study Unit



SPECIFICATIONS SUMMARY

The Friction Study Unit "MEF" allows to illustrate the friction force by simple demonstrations.

It is designed for the study of the relations between friction forces and normal forces, between hard or soft surfaces, between lubricated or dry surfaces and between rolling surfaces for several types of materials.

The unit is assembled in an anodized aluminum profile structure, with steel painted panel.

This unit is mainly composed of:

Friction rollers.

Brake mechanism.

Movement pulley.

Friction cushions set: friction pads having stainless steel, brass, ferodo, nylon and rubber surfaces are provided as standard.

The weight makes the roller set turn while another weight exerts some pressure on the brake, the relation between both of them determines the coefficient of friction for different materials and different operational conditions.

In order to carry out some of the practices with MEF unit 2 set of weights "B type" are required.

Manuals: This unit is supplied with 8 manuals.

Dimensions (approx.): 400 x 400 x 600 mm. Weight: 20 Kg.

More information in: www.edibon.com/products/catalogues/en/units/mechanicsmaterials/general/MEF.pdf

PRACTICAL POSSIBILITIES

- 1.- Investigation of the relations between the friction forces and normal forces between surfaces in contact.
- 2.- Comparison of the values between dry surfaces in contact, using several materials, by the sliding coefficient.
- 3.- Comparison of the friction values for dry and lubricated surfaces.
- 4.- Comparison of the friction force for sliding surfaces with rolling surfaces.
- 5.- Comparison of the friction force of soft and hard rolling surfaces.

7.4- Special Mechanics & Foundry

MCAM. Bell Casting Basic Training Set



Detail of the finished, fettled castings

SPECIFICATIONS SUMMARY

Didactic case for the study of foundry fundamentals. Introduction to sand casting: student experiments with 3 different patterns (bell, anvil and anchor). Operations of ramming up of the moulding sand, melting of the metal, pouring, forming and fettling can be performed step by step. The student will practice in first place with symmetrical pieces and after this with asymmetrical ones.

Training set in a case, containing:

Aluminium cope and drag box, screwable.

Aluminium pattern plate.

3 different aluminium patterns:

The Bell as a natural or an on-piece pattern.

The Anvil as a split, asymmetrical pattern demonstrates the shrinkage cavitation.

The Anchor, as a split, symmetrical pattern.

Rammer. Small downgate and big downgate.

Bell clapper. Bell mountings.

Thermometer.

Saucepan.

Pencil brush.

Pattern-draw tool.

Shovel. Scraper.

Lancet.

Brush.

Separating agent.

2 Kg. metal alloy (melting point 200°C approx.) and 6 Kg. moulding sand in a separate container.

All instruction set is supplied ready to use, including enough test material.

All material is recoverable.

Manuals: This unit is supplied with 8 manuals.

Dimensions (approx.): 600 x 400 x 200 mm. Weight: 15 Kg.

More information in: www.edibon.com/products/catalogues/en/units/mechanicsmaterials/specialfoundry/MCAM.pdf

PRACTICAL POSSIBILITIES

- 1.- Study of foundry fundamentals.
- 2.- Introduction to sand casting: student experiments with 3 different patterns (bell, anvil and anchor).
- 3.- The bell as a natural or a one-piece pattern.
- 4.- The Anvil as a split, asymmetrical pattern, demonstrate the shrinkage cavitation.
- 5.- The Anchor, as a split, symmetrical pattern.

MCLA. Foundry Building-up Training Set 1



Detail of the finished casting, free of sand

SPECIFICATIONS SUMMARY

Didactic case for the study of foundry fundamentals. Operations of ramming up of the moulding sand, melting of the metal, pouring, forming and fettling can be performed step by step. Practice of melting, unmelting and foundry with irregular and asymmetrical patterns.

Making up a casting with cavity (pipe reduction).

Training set in a case, containing:

Aluminium cope and drag box, screwable.

Pattern plate with pattern.

Core box.

Downgate.

Small and big risers.

Shovel.

Brush.

Scraper.

Saucepan.

Ramer.

Pencil brush.

Lancet.

Thermometer.

2 Kg. metal alloy (melting point 70°C approx.), and 6 kg moulding sand in a separate container.

All instruction set is supplied ready to use, including enough test material.

All material is recoverable.

Manuals: This unit is supplied with 8 manuals.

Dimensions (approx.): 600 x 400 x 200 mm. Weight: 15 Kg.

More information in: www.edibon.com/products/catalogues/en/units/mechanicsmaterials/specialfoundry/MCLA.pdf

PRACTICAL POSSIBILITIES

- 1.- Study of foundry fundamentals.
- 2.- To manufacture of a pipe-reducing flange with cavity of 1 kg-mass approx.
- 3.- Practice of melting, unmelting and foundry with irregular and asymmetrical patterns.

MCEN. Centrifugal Casting Building-up Training Set 2



SPECIFICATIONS SUMMARY

This unit is designed for production of hollow bodies in a fast rotating die.

This unit is mounted on a 2mm. thick steel sheet, primed and painted with epoxy paint, and hold by a frame of extruded and anodized aluminium, which provides a great stiffness and resistance.

Three-phase motor that does 1.67A with 2700 rpm.

A variator that controls the motor. It can turn with a maximum frequency of 50Hz (which corresponds to 3000rpm approximately) and a minimum one of 5 Hz. The motor turning speed can be changed from this variator. Turning anticlockwise direction.

Stainless steel cast axis with a diameter of 20 mm.

The cast is cylindrical and is made of aluminium, outer diameter of 82 mm, inner diameter of 70 mm and length of 150 mm.

The cast useless length is 110mm, once the lids have been placed.

The cast is made with a little cone-shape to make easier the extraction of piece towards the inlet side.

A small saucepan in which the tin can be heated.

A crucible from which the tin can be pour in order to the start the experiment.

2 Kg. tin bar.

Thermometer.

All instruction set is supplied ready to use, including enough test material.

All material is recoverable.

Cables and Accessories, for normal operation

Manuals: This unit is supplied with 8 manuals.

Dimensions (approx.): 700 x 500 x 500 mm. Weight: 30 Kg.

More information in: www.edibon.com/products/catalogues/en/units/mechanicsmaterials/specialfoundry/MCEN.pdf

PRACTICAL POSSIBILITIES

- 1.- Study of foundry fundamentals.
- 2.- Production of hollow bodies in a fast rotating die.
- 3.- Centrifugal casting with different turn speeds.
- 4.- Centrifugal casting with different temperatures of tin.
- 5.- Centrifugal casting for different amounts of tin.

7.5.1- General Strength of Materials

EEFC. Computer Controlled Fatigue Testing Unit *

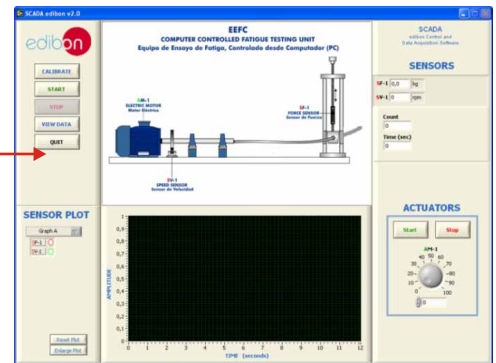
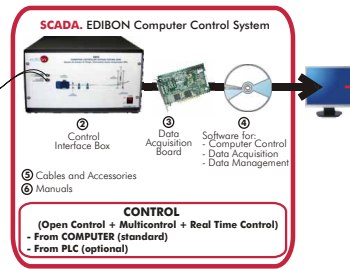

① Unit: EEFC. Fatigue Testing Unit

SPECIFICATIONS SUMMARY
Items supplied as standard

① EEFC. Unit:

With this unit it is possible to determine the basic principles of the fatigue strength testing. Anodized aluminium structure and panels in painted steel. Diagram in the panel.

Electrical motor of 0.37 kW, maximum speed: 1500 rpm. Motor speed control by a frequency regulator, controlled by the control software. Metallic protective covers, one for the motor axis zone, and other for the test specimen zone, with safety protection system to avoid accidents. Safety switch that stops the motor when the metallic protection is removed. Automatic shut down on specimen fracture controlled from the control software (from the computer (PC)).

Test specimens (test bars): 2 stainless steel AISI 304L cylindrical test specimens; 6 stainless steel AISI 304L cylindrical test specimens, with different notches; 2 carbon steel F-1 cylindrical test specimens; 6 carbon steel F-1 cylindrical test specimens, with different notches; 2 steel F-212 cylindrical test specimens; 6 steel F-212 cylindrical test specimens, with different notches. Loading device with load cell. Adjustment using threaded spindle with hand wheel. Force sensor, range: 0-30 kg.

Speed sensor and cycle counter: range: from 0 to 5000 rpm. Speed and force measurement.

② EEFC/CIB. Control Interface Box :

With process diagram in the front panel. The unit control elements are permanently computer controlled. Simultaneous visualization in the computer of all parameters involved in the process. Calibration of all sensors involved in the process. Real time curves representation. All the actuators' values can be changed at any time from the keyboard. Shield and filtered signals to avoid external interferences. Real time control with flexibility of modifications from the computer keyboard of the parameters, at any moment during the process. Open control allowing modifications, at any moment and in real time, of parameters involved in the process. 3 safety levels: mechanical in the unit, electronic in the control interface, and the third one in the control software.

③ DAB. Data Acquisition Board:

PCI Data acquisition National Instruments board to be placed in a computer slot. 16 Analog inputs. Sampling rate up to: 250 KS/s. 2 Analog outputs. 24 Digital Inputs/Outputs.

④ EEFC/CCSOF. Computer Control + Data Acquisition + Data Management Software:

Flexible, open and multicontrol software. Management, processing, comparison and storage of data. Sampling velocity up to 250,000 data per second. It allows the registration of the alarms state and the graphic representation in real time.

⑤ Cables and Accessories, for normal operation.

⑥ Manuals: This unit is supplied with 8 manuals.

Dimensions (approx.) = Unit: 1000 x 600 x 600 mm. Weight: 50 Kg. Control Interface: 490 x 330 x 310 mm. Weight: 10 Kg.

More information in: www.edibon.com/products/catalogues/en/units/mechanicsmaterials/strengthmaterials/EEFC.pdf

PRACTICAL POSSIBILITIES

- 1.- Determination of the basic principles of fatigue strength testing.
 - 2.- Influence of the type of material on fatigue strength.
 - 3.- Determination of the influence of notching and surface finish on fatigue strength.
 - 4.- Influence of different curvature radio and surface finish on fatigue strength.
 - 5.- Influence of the section on fatigue strength.
 - 6.- Fatigue strength of specimens (bars) subject to cyclic bending load.
 - 7.- Preparation of a stress-number (S-N) diagram.
 - 8.- Obtaining of S-N curves.
- Other possible practices:
- 9.- Sensors calibration.
 - 10-28.- Practices with PLC.

EEU/20KN. Universal Material Testing Unit

SPECIFICATIONS SUMMARY

The "EEU/20KN" unit has been designed for basic practices and experiments on materials testing. This unit allows to make tests of tensile strength, compressive strength, Brinell hardness, bending, shear and cupping, etc. Besides is included a Computer Data Acquisition System and the unit can also be fitted with electronic force and position measurement.

Diagram in the front panel with similar distribution to the elements in the real unit. Metallic base unit with anodized aluminium structure.

Base unit with feet. Hand wheel. Load gauge. Upper crosspiece. Lower crosspiece. Gauge for deformation displacement. Frame pillars. Gripping heads. Test load is generated using a hand operated hydraulic systems. Max. stroke: 45mm. Max. test force: 20kN. Dynamometer: 0-20kN. Elongation gauge: 0-10mm. Sets of tensile strength specimens. Sets of hardness specimens. Test sphere diameter: 10 mm.

Accessories included:

- EEU-01. Set of tension test rods: aluminium, steel, brass, copper.
- EEU-02. Set of Brinell specimens: aluminium, steel, brass, copper.
- EEU-03. Compressive test specimens set.
- EEU-04. Set of 2 compression plates, with fastening elements.
- EEU-05. Bending device.
- EEU-06. 2 sets of coil spring test.
- EEU-07. Disk spring test.
- EEU-08. Laboratory trolley.
- EEU-09. Electronic force measurement system.
- EEU-10. Data Acquisition System from computer (PC).
- EEU-11. Aluminium tension rods set.
- EEU-12. Steel tension rods set.
- EEU-13. Brass tension rods set.
- EEU-14. Copper tension rods set.
- EEU-15. Set of flat tension specimens (aluminium, steel, brass, copper).
- EEU-16. Aluminium Brinell specimens set.
- EEU-17. Steel Brinell specimens set.
- EEU-18. Brass Brinell specimens set.
- EEU-19. Copper Brinell specimens set.
- EEU-20. Aluminium cupping specimens set.
- EEU-21. Steel cupping specimens set.
- EEU-22. Brass cupping specimens set.
- EEU-23. Copper cupping specimens set.
- EEU-24. Copper shear specimens set.
- EEU-25. Device for Brinell hardness test.
- EEU-26. Measure magnifier for Brinell impression.
- EEU-27. Device for shear test unsymmetrical.
- EEU-28. Device for shearing experiments.
- EEU-29. Device for cupping experiments.
- EEU-30. Chucks for flat tensile specimen.
- EEU-31. Bending specimens (aluminium, steel, copper).

Manuals: This unit is supplied with 8 manuals.

Dimensions (approx.): 700 x 550 x 900 mm. Weight: 60 Kg.

More information in: www.edibon.com/products/catalogues/en/units/mechanicsmaterials/strengthmaterials/EEU-20KN.pdf

PRACTICAL POSSIBILITIES

- 1.- Tensile strength tests.
- 2.- Compressive strength tests.
- 3.- Brinell hardness testing.
- 4.- Bending tests.
- 5.- Shear tests.
- 6.- Cupping tests.
- 7.- Testing of disc and helical springs.
- 8.- Recording of stress diagrams.
- 9.- Recording of strain diagrams.
- 10.- Recording of characteristics curves.
- 11.- Using the Data Acquisition System.



7.5- Strength of Materials

7.5.1- General Strength of Materials

EEFCR. Creep testing Unit



SPECIFICATIONS SUMMARY

Creep is the deformation produced in a material subjected to a constant force at a constant temperature. The Creep Testing Unit is designed to carry out practices on specimens of plastic materials.

Anodized aluminium structure and panel in painted steel.

Diagram in the front panel with similar distribution to the elements in the real unit.

Temperature conditioning box made of acrylic. Here, the adequate temperature conditions to carry out the experiment are created. Inside it, the specimen which will be experimented is located. To reach the temperature, an isotherm bag will be used. To know the experiment conditions, there is a thermometer at the upper part of the box.

Load arm. It is a stainless steel beam on which the loads are applied to the specimen. It pivots on a shaft inserted in the support column. Tensile stress range: 0-35 N/mm².

Support screw for supporting the load arm before starting the experiment.

Clamps. They are into the space to fasten the specimens.

A dial indicator of 10 mm of measurement. It measures the elongation of the specimen which is under the load and temperature concrete conditions.

The specimens are flat type, made in different plastic materials. They have a section of 5 mm x 2 mm to make easier the experiments. They are made of PVC and Polypropylene.

Set of weights and support hook.

Manuals: This unit is supplied with 8 manuals.

Dimensions (approx.): 700 x 350 x 600 mm. Weight: 25 Kg.

More information in: www.edibon.com/products/catalogues/en/units/mechanicsmaterials/strengthmaterials/EEFCR.pdf

PRACTICAL POSSIBILITIES

- 1.- Experimental determination of the creep limit of different plastic materials.
- 2.- Experimental determination of the relation between the deformation caused by the creep according to the time on plastic specimens.
- 3.- Determination of the temperature effect in the creep behaviour of a plastic material.
- 4.- Demonstration of the three phases of the creep.

EEICI. Charpy and Izod Impact Testing Unit



SPECIFICATIONS SUMMARY

The EEICI unit is designed for carrying out resilience or impact tests on plastic materials.

The EEICI unit is designed for testing plastic specimens. Therefore, it is a type of pendulum that reaches potential energy thresholds that are adequate for breaking these plastic specimens. The specimens and the tests are developed according to the following standards:

- Charpy method: Standard ISO 179.
- Izod method: Standard ISO 180.

The EEICI unit for impact testing with the Charpy and the Izod pendulums is mounted on an aluminium structure that provides the device great rigidity. The aluminium structure is covered by a steel panel, painted with epoxy paint.

The unit consists of the following elements:

Pendulum: It is supported by bearings and has a length of 330 mm. On one of its ends we can mount the appropriate hammer for each test, be it Charpy or Izod.

Initial angle: 150°. Charpy potential energy: 5 J, 7.5 J and 10 J.

Izod potential energy: 8.5 J.

Hammers:

The Charpy Hammer has the shape of a "C" and it is used for impact tests on specimens that are supported on both ends.

The Izod Hammer is used to impact on specimens that are fitted vertically.

Charpy clamp. It is composed with the accessories needed for supporting the specimens, according to Standard ISO 179.

Izod clamp. It is composed with the accessories needed for supporting the specimens, according to Standard ISO 180.

A graduated disc with a pointer will mark the energy used to break the specimen.

Specimens made in different plastic materials:

They have a notch in order to make their braking easier.

They are made of PVC, PTFE and Acrylic.

Support system for the pendulum at the starting point of the test.

Protection transparent cover that allows the safe viewing of the experiments by the student.

Manuals: This unit is supplied with 8 manuals.

Dimensions (approx.): 1000 x 600 x 600 mm. Weight: 70 Kg.

More information in: www.edibon.com/products/catalogues/en/units/mechanicsmaterials/strengthmaterials/EEICI.pdf

PRACTICAL POSSIBILITIES

- 1.- Experimental determination of the energy needed in order to break specimens of different materials using the Charpy method.
- 2.- Experimental determination of the energy necessary to break specimens of different materials using the Izod method.
- 3.- Experimental determination of the pendulum's friction losses.

7.5.1- General Strength of Materials

EEDB. Brinell Hardness Testing Unit



SPECIFICATIONS SUMMARY

Testing unit for measuring Brinell hardness of steels and other metals whether flat, round or irregular shape.
 This unit accepts flat, round or irregular shaped specimens.
 250- 3000 kgf capacity.
 Direct reading automatic zero setting depth gauge.
 Dial gauge of 80mm diameter.
 Electric motor.
 Load to be applied by dead weight and lever system.
 Flat anvil and "v" anvil.
 Max. test height : 410mm.
 Max. depth of spindle below base: 180mm.
 Depth of throat: 200mm.
 5 mm ball holder with 5 additional balls. 10 mm ball holder with 5 additional balls.
 Test block of approx. 250 HB.
 Telescopic screw driver and allen spanners.
 Direct measurement on smooth or shot-blasted surfaces.
 It is equipped with a special workpiece clamp.
 Manuals: This unit is supplied with 8 manuals.
 Dimensions (approx.): 650 x 400 x 1200 mm. Weight: 400Kg.

More information in: www.edibon.com/products/catalogues/en/units/mechanicsmaterials/strengthmaterials/EEDB.pdf

MVV. Unsymmetrical Cantilever Unit



SPECIFICATIONS SUMMARY

The unsymmetrical cantilever unit is designed to demonstrate the unsymmetrical bending of beams.
 Simple experiments may be carried out to determine the deflections Δ_U and Δ_V at the free end of cantilevers of different sections for varying angles of applied load from which the relationship between $\frac{\Delta_U}{W}$ and $\frac{\Delta_V}{W}$ may be determined graphically.

The system consists of a vertical cantilever rigidly clamped at its lower end to the main column which is attached to a rigid structure. Beams of different sections may be used.

Bench-top unit mounted on a structure of anodized aluminium profiles, with painted steel panel, and with legs.

The unit basically consists on:

A main column, made in aluminium.

A loading head, made in aluminium, located at the upper end of the column, which can rotate 180° at 15° intervals around the vertical axis of the beam.

Set of pulley, located at the loading head, to apply a horizontal load.

2 Dial gauges of 0-25 mm and 0.01 mm accuracy, to measure Δ_U and Δ_V deflections.

2 Steel beams are supplied, one with rectangular section and the other one with L shape section.

Manuals: This unit is supplied with 8 manuals.

Dimensions (approx.): 400 x 300 x 400 mm. Weight: 14 Kg.

More information in: www.edibon.com/products/catalogues/en/units/mechanicsmaterials/strengthmaterials/MVV.pdf

PRACTICAL POSSIBILITIES

- 1.- Determining the deflection of the beam depending on the intensity of the force applied.
- 2.- Determining the deflection of the beam depending on the direction of the force applied.
- 3.- Determining the Δ_U and Δ_V deflections at free ends of cantilevers.
- 4.- Studying the deflections at two planes, for several sections.
- 5.- Determining deflections for different angles of force applied.
- 6.- Studying the rigidity variation.
- 7.- Determining the position of the torsion centre of the beam (with accessory MVVC).

MUP. Loading of Struts Unit



SPECIFICATIONS SUMMARY

MUP is a unit made by EDIBON to demonstrate the phenomenon of crippling load for struts.

The unit has been designed to carry out tests with different lengths and different ends conditions:

-Both ends pinned. -Both ends fixed. -One end pinned and the other fixed.

MUP is designed to work with two types of struts: of circular section and rectangular section. Therefore, the experiments can be carried out according to the different ends conditions and the different lengths between 400 mm and 800 mm.

The unit basically consists on:

Two porticoes:

-A 1 m height portico, where the test struts are placed. It is designed to accommodate struts of different height by using two pins. Therefore, at the upper and lower parts there are special clamps to subject the strut to the desired end conditions.

-A 50cm height portico, where the experimental strut will be subjected to load by means of a spring balance situated at the upper part and which will tend to elevate the lower beams, so the experimental strut will be subjected to compression.

Bubble level to equilibrate the system.

Regulation nut which, together with a bubble level, will allow to equilibrate the horizontal beams.

Balance 0-50 kg to measure the strut compression load. Weight of 1 kg.

Dial gauge, measurement range: 0-20 mm, to check the strut flexion according to the experimental strut is subjected to load.

Accessory to create perturbing load over the test strut, which consists of support, pulley and set of masses.

Set of masses and set of test struts.

Manuals: This unit is supplied with 8 manuals.

Dimensions (approx.): 800 x 400 x 1200 mm. Weight: 60 Kg.

More information in: www.edibon.com/products/catalogues/en/units/mechanicsmaterials/strengthmaterials/MUP.pdf

PRACTICAL POSSIBILITIES

- 1.- Experimental determination of the relation between the crippling load for different thickness, materials and shapes of the test struts.
- 2.- Experimental determination of the relation between the crippling load and the test struts ends conditions.
- 3.- To establish the critic load differences for different lengths and different strut sections.
- 4.- Determination of the crippling load for vertical beams for different slenderness modulus and several conditions at the ends.
- 5.- Rectangular test specimens for the deflection occurs in a determined plane of lengths.
- 6.- Application of a light lateral load to measure the lateral deflection.

7.5- Strength of Materials

7.5.1- General Strength of Materials

MTP. Twist and Bend Machine



SPECIFICATIONS SUMMARY

The MTP apparatus designed by EDIBON is an unit to demonstrate the phenomenon of torsion and flexion in steel beams. Its dimensions and weights make it ideal to develop the practices in only one classes session.

Bench-top unit with structure made in anodized aluminum profiles, with painted steel panel. It is mounted on 4 regulable in height gum legs.

The unit includes:

Universal Torsion and Flexion machine, which allows to carry out both types of experiment.

It consists of two stainless steel guides of 800 mm, which allow to displace the supports in the whole range. This allows the student to carry out the experiment of beams of different length.

4 Test pieces with circular section, of 8 mm diameter, of different materials (steel, aluminum, brass, bronze). They have marks every 50 mm to facilitate the measurement of the beam length.

7 Test pieces with different rectangular cross section made in stainless steel. It also has marks every 50 mm to facilitate the measurement of the beam length being studied.

Dial gauge of 0-10 mm to measure the deformations.

Set of weights adapted to the MTP unit with special hooks for each type of experiment.

Manuals: This unit is supplied with 8 manuals.

Dimensions (approx.): 850 x 500 x 650 mm. Weight: 18 Kg.

More information in: www.edibon.com/products/catalogues/en/units/mechanicsmaterials/strengthmaterials/MTP.pdf

PRACTICAL POSSIBILITIES

- 1.- Study of the beams flexion for different sections and lengths.
- 2.- Determination of the Elasticity Modulus for stainless steel.
- 3.- Study of the relation between the torsional moment, beam length and torsion angle of one shaft.
- 4.- Determination of the Rigidity Modulus for steel, bronze and aluminum.

MFV. Beam Deflection Unit

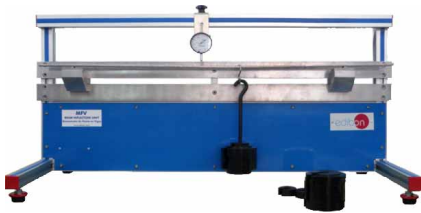

SPECIFICATIONS SUMMARY

This unit has been designed to enable the students to observe and study the following phenomena in simple supported beams and cantilever beams:

- Relation between the deflections and the applied loads.
- Effect of the length and the cross section on the beam behaviour. Ex: deflection load ratio.

Structure of anodized aluminium and stainless steel.

Metallic guide with a graduated ruler for positioning the different supports.

2 Stainless steel simple supports.

1 Stainless steel cantilever support.

Dial gauge 0-25 mm range.

It allows experimentation with beams up to 1000 mm length for their study.

Three test beams with different cross sections and 1 m. of length are supplied.

The unit allows test, as:

- cantilever beam simple.
- beam with a cantilever support fixed end and a simple support in the other end.
- beams with two simple supported points.

Adjustable legs for balancing the unit.

Manuals: This unit is supplied with 8 manuals.

Dimensions (approx.): 1200 x 400 x 400 mm. Weight: 20 Kg.

More information in: www.edibon.com/products/catalogues/en/units/mechanicsmaterials/strengthmaterials/MFV.pdf

PRACTICAL POSSIBILITIES

- 1.- Study the characteristics of simply-supported and cantilever beams.
- 2.- Determination of the relationship between applied load and deflection.
- 3.- Beam supported on its two ends with a central loading point.
- 4.- Study of the variation of length in deflection.
- 5.- The effect the beam 's length has on a centrally loaded beam supported by its two ends.
- 6.- The effect of the cross-section of deflection.
- 7.- The effect the beam 's section on a centrally loaded beam supported on its two ends.
- 8.- Cantilever beam with a load on one of its ends.
- 9.- The effect the beam 's length has on a cantilever with a load on one of its ends.
- 10.- The effect of a cross-section in a cantilever with a load on one of its ends.
- 11.- Beam supported by two points and subjected to a momentum of uniform bending.
- 12.- Study of bending, application of loads at distints points with fixed or free ends.

MTB. Torsion Unit



SPECIFICATIONS SUMMARY

The MTB unit has been designed by EDIBON to study the elastic torsion characteristics of circular bars. The unit allows us to test the proprieties of torsion of circular bars at different lengths, from 0 to 300 mm.

The MTB unit allows the student to test the fundamentals of torsion and carry out experiments to demonstrate:

- 1.- Testing of the elastic torsion equation for circular bars.
- 2.- The experimental determination of Modulus of Rigidity for different materials.

The unit is mounted on an anodized aluminum structure with painted steel plates.

The main structure is supported on aluminium blocks. The two guide bars are made in stainless steel, the rest of the components are aluminium.

The two guides of the unit are for sliding the mobile clamp on it, testing bars with different length.

Mobile clamp located at one end that has a crank in the bottom to adjust the test bar to the desired length. It is made in stainless steel.

Fixed clamp, consists of two bearings which allow it to turn. It has an arm on which the force is applied. It has a notch which is placed at 60 mm from the longitudinal axis of the test bar, to carry out the measurements. The dial gauge should be placed on this notch to properly measure the deformation. The clamp is made in stainless steel.

Test bars: standard supply of 3 test bars: steel, brass and aluminium. They are 8 mm of diameter and 350 mm of length. They have marks every 50 mm, which allow the student to measure different lengths of the bars easily.

A Dynamometer up to 10 Kg, to apply the forces on the test bar.

A Dial gauge of 0- 10 mm, to measure the deformation of the test bar subjected to the force.

Manuals: This unit is supplied with 8 manuals.

Dimensions (approx.): 600 x 400 x 600 mm. Weight: 15 Kg.

More information in: www.edibon.com/products/catalogues/en/units/mechanicsmaterials/strengthmaterials/MTB.pdf

PRACTICAL POSSIBILITIES

- 1.- Verification of the elastic torsion equation of circular bars.
- 2.- Experimental determination of the relationship between the torsion moment and the shaft angular deformation.
- 3.- Experimental determination of the relationship between the test bar length and the shaft turn angle for a same torsional force.
- 4.- Experimental determination of the value of the Modulus of Rigidity for steel, brass and aluminium.

7.5.1- General Strength of Materials

MFLT. Strut Unit



SPECIFICATIONS SUMMARY

The MFLT apparatus developed by EDIBON is an unit to demonstrate the buckling load for struts at compression. This unit allows the student to obtain experimentally the critic Buckling Load of slender struts subject to compression. The unit allows to study the buckling of specimens of different lengths between 300 mm and 625 mm and with different support conditions:

- Both ends pinned. - Both ends fixed. - One end pinned and the other fixed.

This unit is mounted on a structure of anodized aluminium profiles with steel panels and supports painted.

The unit basically consists on:

-2 guides to slide the mobile clamp, made in stainless steel, that allow to test specimens up to 650 mm length.

-Universal supports to fasten the test specimen, according to the required end conditions.

-Mobile clamp located at one end. It has a lower crank to adjust the test specimen to the desired length. Therefore, it has a system to measure the applied force, by measuring the deformation of an elastic metallic ring. The clamp can be placed in position of pinned end or fixed end, according to the desired practice.

-Fixed clamp, which has several functions. The upper crank has two positions according to the desired end conditions for the clamp. Another function is the system to apply the force over the specimen composed of a crank, that causes the compression on the structure when turning to the right.

-Dial gauge of 0-5 mm range, to determine the compression load at which the test specimen is subjected.

There are 9 test specimens of different lengths included, made in tempered steel of 20 mm x 1.5 mm thickness.

Manuals: This unit is supplied with 8 manuals.

Dimensions (approx.): 1000 x 300 x 250 mm. Weight: 15 Kg.

More information in: www.edibon.com/products/catalogues/en/units/mechanicsmaterials/strengthmaterials/MFLT.pdf

PRACTICAL POSSIBILITIES

- 1.- Study of the deformation in beams.
- 2.- Checking-up of the theory of Euler for beams.
- 3.- Determination of relation between Buckling Load and slenderness modulus for axial loads.
- 4.- Determination of the limit Buckling Load of flat specimen, pinned in both ends.
- 5.- Determination of the limit Buckling Load of flat specimen, one end fixed and the other pinned.
- 6.- Determination of the limit Buckling Load of flat specimen, with both ends fixed.

MVS. Suspension Bridge Unit

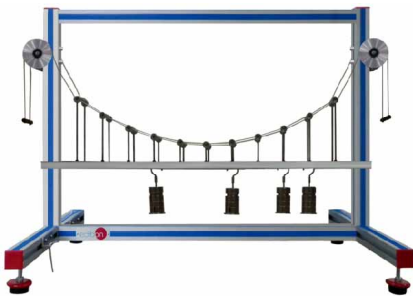

SPECIFICATIONS SUMMARY

MVS is a visual realistic suspension bridge that allows to compare experimental and theoretical cable tensions and to study the performance of the suspension bridge under different load conditions.

This unit has been designed to represent a simple application of a suspended beam and it can be used to determine experimentally the tension in the cables supporting a beam carrying a series of distributed loads.

The MVS unit is assembled in an anodized aluminum and steel structure.

A metal beam is supported on tie rods attached at pivot points to cross members threaded on the supporting cables which pass over pulleys.

Tension in the supporting cables is determined by attaching suitable masses or weights to the cables stirrups.

Loads may be applied to the beam by attaching masses or weights at different loading points.

1 set of weights and ropes are supplied.

Manuals: This unit is supplied with 8 manuals.

Dimensions (approx.): 850 x 380 x 510 mm. Weight: 20 Kg.

More information in: www.edibon.com/products/catalogues/en/units/mechanicsmaterials/strengthmaterials/MVS.pdf

PRACTICAL POSSIBILITIES

- 1.- Demonstration of the characteristics of a simple suspension bridge.
- 2.- Determination of the experimental tension in the supporting cables.
- 3.- Observation the stability of the structure.
- 4.- Examination of the relationship between applied loads and the suspension cable tension.
- 5.- To determine experimental value of the tension in the supporting cables of a suspended beam subjected to a uniformly distributed load.
- 6.- Comparison of theoretical and experimental results.

MFL. Two Pinned Arch Unit



SPECIFICATIONS SUMMARY

The unit (MFL) enables to determine experimentally the horizontal component of the abutment thrust of a two hinged arch beam.

The beam is supported on ball bearing rollers attached to each end of the beam and the horizontal movement of the free end is indicated by a dial gauge so that the beam can be returned to it's original unloaded span.

The horizontal thrust force is applied to the free end of the beam by means of masses or weights attached to a cord passing over the ball bearing pulleys.

Varying loads can be applied to the beam by means of load hangers and masses. A dial gauge enables to measure the vertical displacement.

It is a bench-top unit with structure made in anodized aluminium and steel.

Steel arch beam.

2 Dial gauges:

range: 0-10 mm.

Cord with a hook.

Manuals: This unit is supplied with 8 manuals.

Dimensions (approx.): 700 x 400 x 700 mm. Weight: 15 Kg.

More information in: www.edibon.com/products/catalogues/en/units/mechanicsmaterials/strengthmaterials/MFL.pdf

PRACTICAL POSSIBILITIES

- 1.- Demonstration of the characteristics of a two pinned arch.
- 2.- To examine the relationship between applied loads and horizontal thrust.
- 3.- Determination of the horizontal thrust in a support point of an arch beam subjected to a vertical load.
- 4.- Study of the horizontal force change with the magnitude of the applied load.
- 5.- To determine the experimental value of the horizontal component thrust at the abutment end of a two pinned arch beam subjected to a vertical load.

7.5- Strength of Materials

7.5.1- General Strength of Materials

MPO. Portal Frame Unit



SPECIFICATIONS SUMMARY

The portal frame unit has been designed to determine the deflection at the load point for a rectangular portal frame subjected to horizontal and vertical loads.

The system is formed by a frame attached to a rigid base and loads can be applied by mass hangers and a range of masses or weights. The horizontal and vertical deflections of the frame can be measured by means of dial gauges.

Steel portal frame.

Dial gauge:

range: 0-10 mm.

Cord with a hook.

Hanger.

Manuals: This unit is supplied with 8 manuals.

Dimensions (approx.): 700 x 400 x 450 mm. Weight: 15 Kg.

More information in: www.edibon.com/products/catalogues/en/units/mechanicsmaterials/strengthmaterials/MPO.pdf

PRACTICAL POSSIBILITIES

- 1.- To determine the experimental value of the deflection at the load point for a rectangular portal frame subjected to a vertical load.
- 2.- To determine the experimental value of the deflection at the load point for a rectangular portal frame subjected to a horizontal load.
- 3.- To compare the theoretical and experimental results.

MDB. Deflection of Curved Bars Unit



SPECIFICATIONS SUMMARY

The Deflection of Curved Bars unit is designed to enable the student to determine experimentally the horizontal and vertical displacements at the free end of various curved bars when subject to single concentrated load.

"MDB" unit consists of a structure of steel that allows the incorporation of different curved bars to be studied. It allows tests with curved bars of different shape.

The use of two dial gauges placed perpendicularly to each other makes it possible to determine the displacements produced in both directions.

The load is applied when hanging weights in the application point.

Bench-top unit mounted on a structure of anodized aluminium, with painted steel panel, and with regulable in height legs.

The unit basically consist of:

Structure of steel on which the dial gauges are mounted and clamps for the test bars.

2 Dial gauges with range from 0-10 mm, to measure the deformation of the test bar subjected to a force.

4 Test curved bars, made of steel, with different lengths and curvatures.

Set of weights.

Steel hook to hand the weights and it is hanging in the application point of the force.

Manuals: This unit is supplied with 8 manuals.

Dimensions (approx.): 370 x 220 x 400 mm. Weight: 6 Kg.

More information in: www.edibon.com/products/catalogues/en/units/mechanicsmaterials/strengthmaterials/MDB.pdf

PRACTICAL POSSIBILITIES

- 1.- Study of deflection of curved bars.
- 2.- Determination of the horizontal and vertical displacements at the free end of various curved bars when subject to single concentrated loads.
- 3.- Study of the different types of bars geometry and for different positions.
- 4.- Measurement of the horizontal and vertical displacements produced at the free end of the curved bar.
- 5.- Effect of the load value in the bar response.
- 6.- Effect of the bar morphological characteristics in its response to the load.

MMF. Shear Force and Bending Momentum Unit



SPECIFICATIONS SUMMARY

This unit has been designed to show experimentally that in a cantilever beam subject to transverse loads, at any cross section of the beam:

- The shear force is the algebraic sum of the transverse components of the forces to one side of the section.

- The bending moment is the algebraic sum of the moments of the forces to one side of the section.

Several experiments will be carried out in order to determine the magnitudes of these moments and shear forces, while observing the bending process in a beam.

An articulated structure makes it possible to convert the application of one vertical force into both a bending moment and a shearing force on the beam. Both effects are created by the use of a set of weights that balance the system using a double-pulley system.

Constructed on aluminium profiles with painted steel panels.

Double -pulley system which allows us to achieve equilibrium of the bending moment on the beam.

Double -pulley system which allows us to achieve equilibrium of the shear force on the beam.

Different application points for the loads.

"MMF" unit uses a rule made in methacrylate that allows us to equilibrate the system with the absence of weights before beginning each experiment.

3 Hooks to hang weights are provided to carry out the experiments.

Manuals: This unit is supplied with 8 manuals.

Dimensions (approx.): 400 x 216 x 350 mm. Weight: 8 Kg.

More information in: www.edibon.com/products/catalogues/en/units/mechanicsmaterials/strengthmaterials/MMF.pdf

PRACTICAL POSSIBILITIES

- 1.- Study of cantilever beams subject to loads at different points.
- 2.- Demonstration of the shear force as the algebraic sum of the transverse components of the forces on one side of the section.
- 3.- Study of the equilibrium and the applied balancing forces when the applied masses are varied.

7.5.1- General Strength of Materials

MVL. Free Vibration Unit

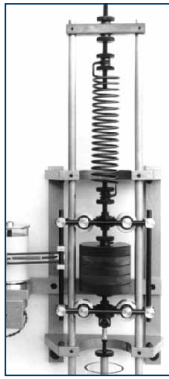

SPECIFICATIONS SUMMARY

Demonstrations may be carried out to illustrate free and damped vibrations of a simple spring-mass system having one degree of freedom and the response of a second order mechanical system to a step input.

Experiments can be carried out by students to investigate the relationship between the mass of the body, the stiffness of the spring, the periodic time or frequency of oscillation and to observe the effect of viscous damping on the system.

Springs of various stiffness and suitable masses are supplied. The dashpot is adjustable to provide a wide range of damping.

A pen attached to the vibrating frame and a paper strip driven by a synchronous motor provide the means of producing amplitude/time recordings.

Manuals: This unit is supplied with 8 manuals.

Dimensions (approx.): 600 x 350 x 1000 mm. Weight: 30Kg.

More information in: www.edibon.com/products/catalogues/en/units/mechanicsmaterials/strengthmaterials/MVL.pdf 

PRACTICAL POSSIBILITIES

- 1.- To illustrate free and damped vibrations of a simple spring-mass system having one degree of freedom and the response of a second order mechanical system to a step input.
- 2.- To investigate the relationship between the mass of the body, the stiffness of the spring, the periodic time or frequency of oscillation and to observe the effect of viscous damping on the system.

MVL.F. Free & Forced Vibration Unit

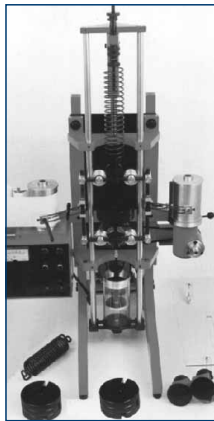

SPECIFICATIONS SUMMARY

Free and Forced Vibration Unit (MVL.F) has been developed to extend the range of demonstration and experiments which may be carried out to include the free and forced vibrations of a single degree of freedom with viscous damping.

Simple adjustment can be made to the unit and the motion of the mass can be readily observed and recorded on the two pen recorders provided. Adopting the well tried features of the simple vibration unit, the mass carriage is constrained by rollers on vertical guide ways to provide minimum uncontrolled damping. Variable viscous damping is provided by an oil dashpot.

Two methods of exciting forced vibration are adopted; by oscillating the upper spring mounting with SHM at variable frequency or by applying a rotating out balance force at variable frequency to the vibrating mass.

Manuals: This unit is supplied with 8 manuals.

Dimensions (approx.): 900 x 600 x 1250 mm. Weight: 80Kg.

More information in: www.edibon.com/products/catalogues/en/units/mechanicsmaterials/strengthmaterials/MVL.F.pdf 

PRACTICAL POSSIBILITIES

Besides the practical possibilities of "MVL" unit, this unit has the following:

- 1.- To investigate the relationship between the mass of the body, the stiffness of the spring and the periodic time or frequency of the oscillation of a simple spring-mass system having one degree of freedom.
- 2.- To investigate the effect of viscous damping on the free vibration of simple spring-mass-damper system.
- 3.- To determine the damping ratio or factor for a given spring-mass-damper system.
- 4.- To investigate the relationship between the amplitude of the steady state vibration of the vibrating mass and the forcing frequency for varying damping ratios.

MOT. Torsional Oscillations Unit



SPECIFICATIONS SUMMARY

The Torsional Oscillations Unit (MOT) enables to illustrate and investigate the torsional oscillations of single rotor, multi-rotor and geared systems.

The unit basically consists of a rigid frame that have some fasteners which enable to situate its different elements. It also has a set of helical springs to simulate long flexible shafts, and a set of discs of varying mass moment of inertias. Suitable gears of various sizes are also provided to change the gear ratio.

Fasteners offer the possibility to modify the arrangement of discs and gears, as well as the use of different types of spring. That enables the study of the different existing systems.

The natural frequencies are of low order and can be counted. Besides, a line drawn axially on the spring serves to illustrate the elastic line and facilitates the experimental location of the nodes.

The MOT unit basically consists of:

- 3 helical torsion springs of different torsion constant.
- 8 metallic discs of different diameter.
- 6 metallic gears with different number of teeth.
- 2 closure plates.

Fastening and anchoring elements.

The unit can be wall mounted.

Manuals: This unit is supplied with 8 manuals.

Dimensions (approx.): 700 x 400 x 400 mm. Weight: 30 Kg.

More information in: www.edibon.com/products/catalogues/en/units/mechanicsmaterials/strengthmaterials/MOT.pdf 

PRACTICAL POSSIBILITIES

- 1.- Single rotor connected to the free end of a torsionally flexible member.
- 2.- Single rotor connected to the free end of a series of torsionally flexible members.
- 3.- Two rotors connected to the free ends of a torsionally flexible member.
- 4.- Two rotors connected to the free ends of a series of torsionally flexible members.
- 5.- Three rotors connected by two torsionally flexible members.
- 6.- Two rotors joined to the free end of two flexible members which are connected by gears whose inertia is appreciable.

MAE. Acceleration of Geared Systems Unit



SPECIFICATIONS SUMMARY

This unit is supported in a metallic frame and can be wall mounted.

The unit basically consists on three shafts, each mounted on ball races and connected by gearing.

A flywheel is attached to one of the shafts.

The discs having varying mass moments of inertia can be attached to the other two shafts.

It permits to change the gear ratios. Gears of suitable sizes are provided.

A torque drum is mounted in each shaft and by means of masses or weights, attached to one of the drums with a cord, allow a way to apply a torque to the system.

The acceleration of the system can be calculated.

In order to carry out some of the practices with MAE unit, 1 set of weights "B type" is required.

Manuals: This unit is supplied with 8 manuals.

Dimensions (approx.): 700 x 350 x 400 mm. Weight: 25 Kg.

More information in: www.edibon.com/products/catalogues/en/units/mechanicsmaterials/strengthmaterials/MAE.pdf 

PRACTICAL POSSIBILITIES

- 1.- To determine the moment of inertia of a single shaft and of this shaft connected to other two shafts.
- 2.- To study the relationship between gears when applying different torques to the system.
- 3.- To determine the acceleration of the system.

7.5- Strength of Materials

7.5.1- General Strength of Materials

MES. Simple Balancing Unit



SPECIFICATIONS SUMMARY

The Simple Balancing Unit (MES) developed by EDIBON is an unit to study and analyze the oscillations and vibrations and how to eliminate or diminish them.

Bench-top unit mounted on a structure made of anodized aluminum profiles, with a painted steel panel and with legs.

All the elements of the MES unit are made of aluminum, stainless steel and treated steel.

This unit has:

An electrical motor with variable speed which can reach 8300 r.p.m.

It has a transmission through pulley and a belt from the motor to the shaft.

An aluminum external disc, that we will name Graduated disc. It has a diameter of 150 mm. The disc have drills to proceed, through fixing the masses, to the system destabilization and then to its subsequent balancing.

The unit is completed with a set of sector masses and weights to do the practices.

Auxiliary module for the electrical supply and the motor control. At its back, there are connections and at its front part it has a potentiometer to control the speed of the motor.

Cables and Accessories, for normal operation.

Manuals: This unit is supplied with 8 manuals.

Dimensions (approx.):

Unit: 450 x 550 x 600 mm. Weight: 25 Kg.

Auxiliary module: 310 x 220 x 145 mm. Weight: 2 Kg.

More information in: www.edibon.com/products/catalogues/en/units/mechanicsmaterials/strengthmaterials/MES.pdf

PRACTICAL POSSIBILITIES

- 1.- Demonstrations and experiments in the balancing of co-planar rotating systems.
- 2.- Balance in a single plane of revolution.
- 3.- Observe the effects on oscillations of

MBU. Universal Bench Mounted Frame



SPECIFICATIONS SUMMARY

The frame is designed to accommodate two units, allowing adequate space for students to work on each piece of equipment simultaneously.

However it is possible to mount three pieces, in the case of the simple transmission system.

Manuals: This unit is supplied with 8 manuals.

More information in: www.edibon.com/products/catalogues/en/units/mechanicsmaterials/strengthmaterials/MBU.pdf

MCD. Thin Cylinder Unit



SPECIFICATIONS SUMMARY

The Thin Cylinder Unit (MCD) has been developed to enable the student to verify the various analytical formulae with actual measured results.

Strain gauges mounted in various positions and orientations on the cylinder provide an opportunity for students to interpret the strains and stresses for a biaxial stress system.

In the unit means are provided for relieving the cylinder of all longitudinal stress, so that the value of Poisson's Ratio and Young's Modulus for the cylinder material may be accurately determined.

The thin cylinder unit and hand operated pump are mounted on a bench-top base plate.

A thin wall tube contains two pistons.

The first piston is located axially; it extends beyond the end of the tube and is drilled to suit a pressure gauge and a high pressure flexible rubber hose connecting the hand operated pressure pump to the unit. This piston also has an in-built pressure relief valve. The oil from the relief valve returns to the pump reservoir connection by means of flexible pipe.

The second piston is free to move axially within the tube, but its travel outwards is limited by a plate and end-cap.

The cylinder unit which is resting on the four pins is supported on a frame and located axially by a fixed stop and an adjustable stop.

Maximum test pressure: 40 bar.

Technical data about the thin cylinder unit:

Reservoir capacity: 75 cm³. Recommended oil: Castor oil. Pressure gauge (Manometer): 0-50 bar. Pre-set relief valve setting: 450psi approx. Cylinder material: Aluminium alloy. Strain gauges: Foil type.

Six active strain gauges are cemented onto the cylinder to allow the measurement of surface strains at various angles, and other six temperature compensating gauges are cemented to a plate.

With the unit is supplied a strain gauges console with selector for the different strain gauges. The measurement of the selected gauge is shown in a display. The reading visualized in the display gather the compensation due to temperature.

Manuals: This unit is supplied with 8 manuals.

Dimensions (approx.):

Unit: 660 x 400 x 300 mm. Weight: 24 Kg.

Strain gauges console: 310 x 200 x 140 mm. Weight: 5 Kg.

More information in: www.edibon.com/products/catalogues/en/units/mechanicsmaterials/strengthmaterials/MCD.pdf

PRACTICAL POSSIBILITIES

- 1.- Determination of Young's modulus and Poisson's ratio. Open ends condition.
- 2.- Determination of Young's modulus and Poisson's ratio. Closed ends condition.
- 3.- Determination of theoretical strain. Open ends condition.
- 4.- Determination of theoretical strain. Closed ends condition.
- 5.- Study with Mohr Strain Circle and determination of circumferential, biaxial, radial and longitudinal stresses. Open ends condition.
- 6.- Study with Mohr Strain Circle and determination of circumferential, biaxial, radial and longitudinal stresses. Closed ends condition.

7.5.2- Strength of Materials (Photoelasticity)

EFO. Photoelasticity Unit

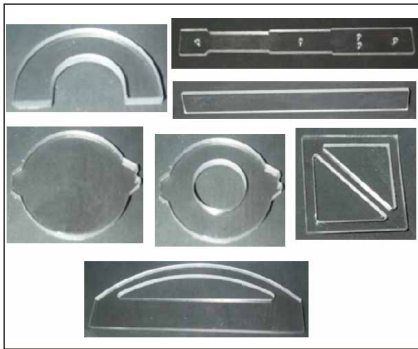
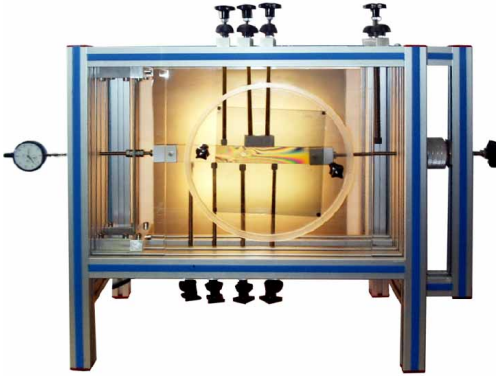

EFO-K1. Kit of Static Test Specimens (basic kit)

SPECIFICATIONS SUMMARY

Unit for photoelasticity practices, illustrating the subjects of the Photoelasticity theory, the Elasticity theory, Strength of Materials, and Structure theory.

It is very suitable for the introduction and study of photoelasticity: optical elements, isochromatic, isoclinic, band order, band factor, edge tensing, etc.

Using this unit photoelastic experiments and practices of transparent test specimens (models) may be performed.

Bench-top unit.

Anodized aluminium structure.

Light source, two fluorescent tubes of 30 cm and 8W.

Monochromatic light 35W.

Opalescent diffuser plate.

Double effect polarizing filters (linear polarization and circular polarization), of 30 x 30 cm and protected by methacrylate plates.

Load frame with pulling jack.

Dynamometric bar.

Comparator clock (millesimal indicator).

10 pressure screws and accessories.

This unit is supplied with the EFO-K1. Kit of Static Test Specimens (basic kit), formed by:

N°3. Stepped Rectangular Specimen.

N°4. Compact Circular Specimen.

N°5. Circular with Orifice Specimen.

N°9. Medium Rectangular Specimen.

N°13. "C" Specimen.

N°14. Specimen with Arch.

N°17. Square with Diagonal Bar Specimen.

Cables and Accessories, for normal operation.

Manuals: This unit is supplied with 8 manuals.

Dimensions (approx.): 750 x 400 x 550 mm. Weight: 20 Kg.

Additional and optional Test Specimens: (not included in the standard supply)

-EFO-K2. Kit of Static Test Specimens (advanced kit).

-EFO-K5. Kit of Articulated Structures.

-EFO-K6. Kit of Dynamic Panels.

PRACTICAL POSSIBILITIES

- 1.- Introduction to photoelasticity: optical elements, isochromatic, isoclinic, band order, band factor, edge tension sign, etc.
- 2.- Determination of principal stress difference.
- 3.- Isochromatics.
- 4.- Illustration of the themes about elasticity, strength of materials and structures using photoelastic tests.
- 5.- Pure traction/optical-tensional law.
- 6.- Diametrically compressed disc.
- 7.- Ring with diametrical compression traction.
- 8.- Ring with diametrical compression.
- 9.- Plate with circular drill with traction.
- 10.- Comparison of the effects from different engravings in piece with traction.
- 11.- Pure traction in a piece with section linearly variable.
- 12.- Pure flexion.
- 13.- Simple flexion.
- 14.- Simple flexion, compound beams.
- 15.- Compound flexion.
- 16.- Compound central core of the section.
- 17.- Piece with a great curvature subjected to flexion.
- 18.- Arch built-in with a central charge.
- 19.- Triangular structure.
- 20.- Comparison of the structures.
- 21.- Comparison of the effect of different notches.

More information in: www.edibon.com/products/catalogues/en/units/mechanicsmaterials/strengthmaterials/EFO.pdf

Additional and optional Test Specimens

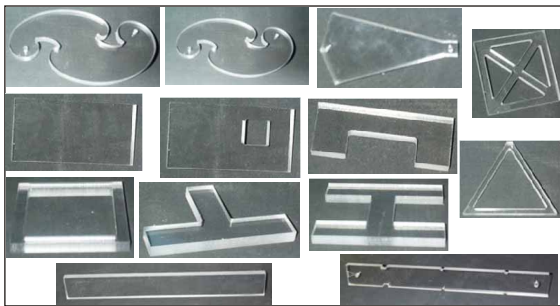

EFO-K2. Kit of Static Test Specimens (advanced kit)

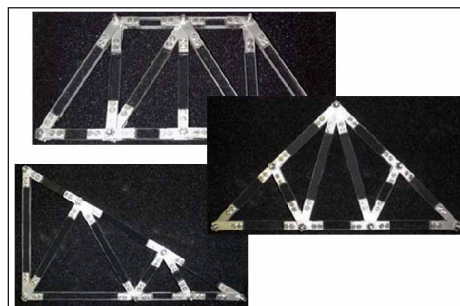

EFO-K5. Kit of Articulated Structures

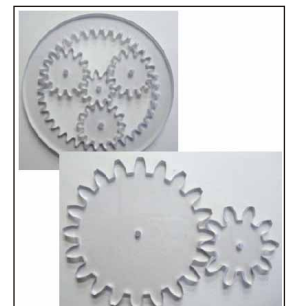

EFO-K6. Kit of Dynamic Panels

7.5- Strength of Materials

7.5.2- Strength of Materials (Photoelasticity)

EFOC. Photoelasticity Unit with Strain Gauges Measurement System

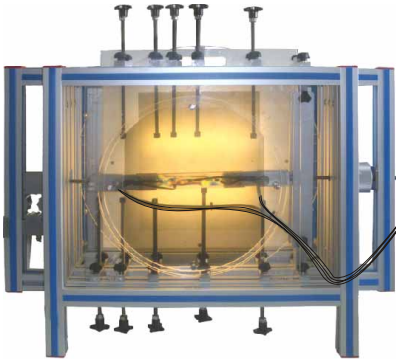

① Unit: EFOC. Photoelasticity Unit with Strain Gauges Measurement System

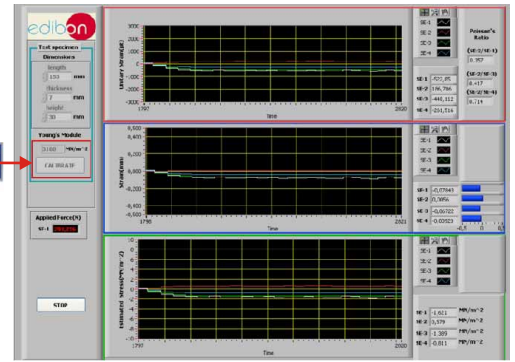
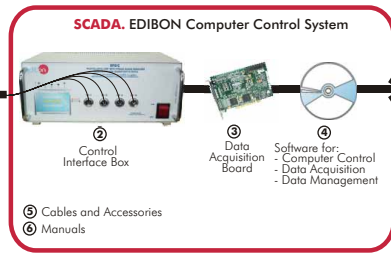

SPECIFICATIONS SUMMARY Items supplied as standard

① EFOC. Unit:

Unit for photoelasticity practices, illustrating the subjects of the Photoelasticity theory, the Elasticity theory, Strength of Materials, and Structure theory. It is very suitable for the introduction and study of photoelasticity: optical elements, isochromatic, isoclinic, band order, band factor, edge tensioning, and for strain and stress analysis and measurement with strain gauges. With the aid of the SCADA system it is possible to analyze and process the captured data during test experiments, making measurements with strain gauges.

-EFO. Unit

Bench-top unit. Anodized aluminium structure. Light source, two fluorescent tubes of 30 cm and 8W. Monochromatic light 35W. Opalescent diffuser plate. Double effect polarizing filters (linear polarization and circular polarization), of 30 x 30 cm and protected by methacrylate plates. Load frame with pulling jack. 10 pressure screws and accessories.

This unit is supplied with:

-EFO-K1. Kit of Static Test Specimens (basic kit), formed by:

- N°3. Stepped Rectangular Specimen.
- N°4. Compact Circular Specimen.
- N°5. Circular with Orifice Specimen.
- N°9. Medium Rectangular Specimen.
- N°13. "C" Specimen.
- N°14. Specimen with Arch.
- N°17. Square with Diagonal Bar Specimen.

-EFO-K3. Kit of Test Specimens with Strain Gauges (basic kit), formed by:

- N°7-G. Trapezoidal Specimen with strain gauges + N°7. Trapezoidal Specimen.
- N°8-G. Big Rectangular Specimen with strain gauges + N°8. Big Rectangular Specimen.
- N°19-G. "T" Beam Specimen with strain gauges + N°19. "T" Beam Specimen.

-EFOC-KIT.

Load cell for direct force measurement. Electronics, hardware and software for strain gauges measurement from PC, and direct force measurement applied to the specimens.

Additional and optional Test Specimens: (not included in the standard supply)

- EFO-K2. Kit of Static Test Specimens (advanced kit).
- EFO-K4. Kit of Test Specimens with Strain Gauges (advanced kit).
- EFO-K5. Kit of Articulated Structures.
- EFO-K6. Kit of Dynamic Panels.

② EFOC/V/CIB. Control Interface Box:

Metallic box. Sensors connectors. Main switch.

③ UDAB. USB Data Acquisition Board:

USB Data acquisition board (National Instruments). Bus USB. 8 Analog inputs. Sampling rate: 10 KS/s (Kilo samples per second). 2 Analog outputs. 12 Digital Inputs/Outputs.

④ EFOC/CCSOF. Computer Control + Data Acquisition + Data Management Software:

Compatible with actual Windows operating systems. Control and Data Acquisition in real time. Management, processing, comparison and storage of data.

⑤ Cables and Accessories, for normal operation.

⑥ Manuals: This unit is supplied with 8 manuals.

Dimensions (approx.) = Unit: 750 x 400 x 550 mm. Weight: 22 Kg.
Control Interface: 310 x 220 x 180 mm. Weight: 3 Kg.

PRACTICAL POSSIBILITIES

- 1.- Introduction to photoelasticity: optical elements, isochromatic, isoclinic, band order, band factor, edge tension sign, etc.
- 2.- Determination of principal stress difference.
- 3.- Isochromatics.
- 4.- Illustration of the themes about elasticity, strength of materials and structures using photoelastic tests.
- 5.- Pure traction/optical-tensional law.
- 6.- Diametrically compressed disc.
- 7.- Ring with diametrical compression traction.
- 8.- Ring with diametrical compression.
- 9.- Plate with circular drill with traction.
- 10.- Comparison of the effects from different engravings in piece with traction.
- 11.- Pure traction in a piece with section linearly variable.
- 12.- Pure flexion.
- 13.- Simple flexion.
- 14.- Simple flexion, compound beams.
- 15.- Compound flexion.
- 16.- Compound central core of the section.
- 17.- Piece with a great curvature subjected to flexion.
- 18.- Arch built-in with a central charge.
- 19.- Triangular structure.
- 20.- Comparison of the structures.
- 21.- Comparison of the effect of different notches.
- 22.- Strain and stress analysis and measurements with strain gauges using computer.

More information in: www.edibon.com/products/catalogues/en/units/mechanicsmaterials/strengthmaterials/EFOC.pdf

Test Specimens: (always included with the EFOC unit)



EFO-K1. Kit of Static Test Specimens (basic kit)

Additional and optional Test Specimens: (not included in the standard supply)

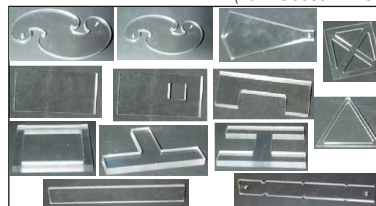

EFO-K2. Kit of Static Test Specimens (advanced kit)



EFO-K4. Kit of Test Specimens with Strain Gauges (advanced kit)

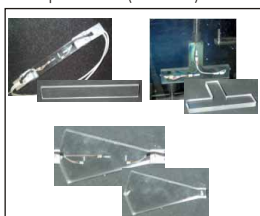

EFO-K3. Kit of Test Specimens with Strain Gauges (basic kit)

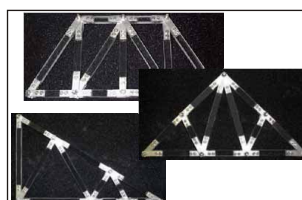

EFO-K5. Kit of Articulated Structures

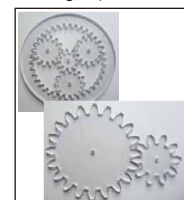

EFO-K6. Kit of Dynamic Panels

7.5.2- Strength of Materials (Photoelasticity)

EFOV. Photoelasticity Unit with Strain Gauges Measurement System and Artificial Vision System

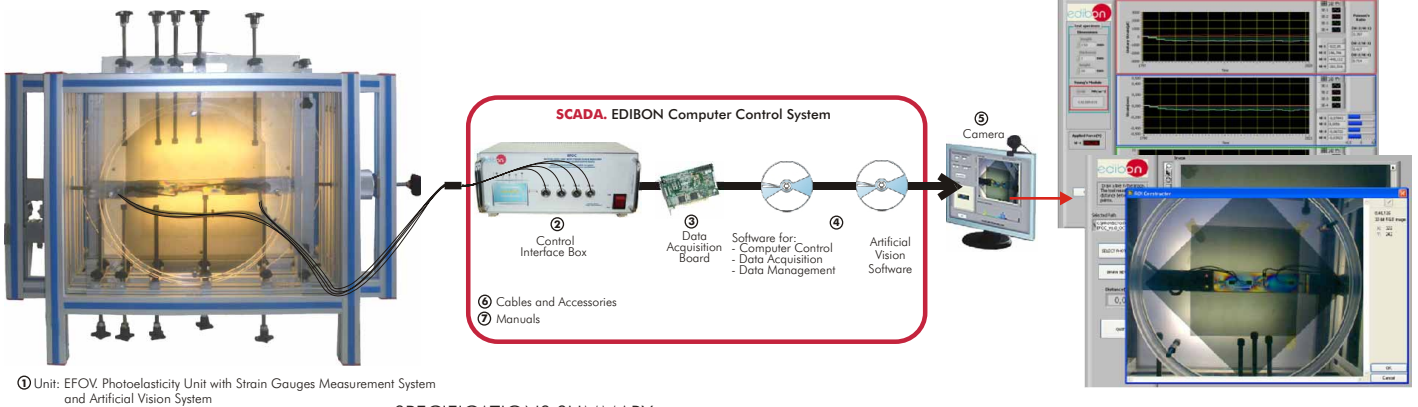

① Unit: EFOV. Photoelasticity Unit with Strain Gauges Measurement System and Artificial Vision System

SPECIFICATIONS SUMMARY
Items supplied as standard

① EFOV. Unit:

Unit for photoelasticity practices, illustrating the subjects of the Photoelasticity theory, the Elasticity theory, Strength of Materials, and Structure theory. It is very suitable for the introduction and study of photoelasticity: optical elements, isochromatic, isoclinic, band order, band factor, edge tensioning, and for strain and stress analysis and measurement with strain gauges. With the aid of the SCADA system it is possible to analyze and process the captured data during test experiments, making measurements with strain gauges. The artificial vision software allows analyze and process the captured images during test experiments.

-EFO. Unit

Bench-top unit. Anodized aluminium structure. Light source, two fluorescent tubes of 30 cm and 8W. Monochromatic light 35W. Opalescent diffuser plate. Double effect polarizing filters (linear polarization and circular polarization), of 30 x 30 cm and protected by methacrylate plates. Load frame with pulling jack. 10 pressure screws and accessories.

This unit is supplied with:

-EFO-K1. Kit of Static Test Specimens (basic kit), formed by:

- Nº3. Stepped Rectangular Specimen.
- Nº4. Compact Circular Specimen.
- Nº5. Circular with Orifice Specimen.
- Nº9. Medium Rectangular Specimen.
- Nº13. "C" Specimen.
- Nº14. Specimen with Arch.
- Nº17. Square with Diagonal Bar Specimen.

-EFO-K3. Kit of Test Specimens with Strain Gauges (basic kit), formed by:

- Nº7-G. Trapezoidal Specimen with strain gauges + Nº7. Trapezoidal Specimen.
- Nº8-G. Big Rectangular Specimen with strain gauges + Nº8. Big Rectangular Specimen.
- Nº19-G. "T" Beam Specimen with strain gauges + Nº19. "T" Beam Specimen.

-EFOC-KIT.

Load cell for direct force measurement. Electronics, hardware and software for strain gauges measurement from PC, and direct force measurement applied to the specimens.

-EFOV-KIT.

Hardware and software for image acquisition and treatment.

Additional and optional Test Specimens: (not included in the standard supply)

- EFO-K2. Kit of Static Test Specimens (advanced kit).
- EFO-K4. Kit of Test Specimens with Strain Gauges (advanced kit).
- EFO-K5. Kit of Articulated Structures.
- EFO-K6. Kit of Dynamic Panels.

② EFOC/V/CIB. Control Interface Box:

Metallic box. Sensors connectors. Main switch.

③ UDAB. USB Data Acquisition Board:

USB Data acquisition board (National Instruments). Bus USB. 8 Analog inputs. Sampling rate: 10 KS/s (Kilo samples per second). 2 Analog outputs. 12 Digital Inputs/Outputs.

④ EFOV/CCSOF. Computer Control+ Data Acquisition+ Data Management Software + Artificial Vision Software:

Compatible with actual Windows operating systems. Control and Data Acquisition in real time. Management, processing, comparison and storage of data.

⑤ EFOV/CAM. Camera.

⑥ Cables and Accessories, for normal operation.

⑦ Manuals: This unit is supplied with 8 manuals.

Dimensions (approx.) = Unit: 750 x 400 x 550 mm. Weight: 22 Kg. Control Interface: 310 x 220 x 180 mm. Weight: 3 Kg.

PRACTICAL POSSIBILITIES

- 1.- Introduction to photoelasticity: optical elements, isochromatic, isoclinic, band order, band factor, edge tension sign, etc.
- 2.- Determination of principal stress difference.
- 3.- Isochromatics.
- 4.- Illustration of the themes about elasticity, strength of materials and structures using photoelastic tests.
- 5.- Pure traction/optical-tensional law.
- 6.- Diametrically compressed disc.
- 7.- Ring with diametrical compression traction.
- 8.- Ring with diametrical compression.
- 9.- Plate with circular drill with traction.
- 10.- Comparison of the effects from different engraves in piece with traction.
- 11.- Pure traction in a piece with section linearly variable.
- 12.- Pure flexion.
- 13.- Simple flexion.
- 14.- Simple flexion, compound beams.
- 15.- Compound flexion.
- 16.- Compound central core of the section.
- 17.- Piece with a great curvature subjected to flexion.
- 18.- Arch built-in with a central charge.
- 19.- Triangular structure.
- 20.- Comparison of the structures.
- 21.- Comparison of the effect of different notches.
- 22.- Strain and stress analysis and measurements with strain gauges using computer.
- 23.- Image acquisition and treatment with software.

More information in: www.edibon.com/products/catalogues/en/units/mechanicsmaterials/strengthmaterials/EFOV.pdf

Test Specimens:

(always included with the EFOV unit)



EFO-K1. Kit of Static Test Specimens (basic kit)



EFO-K3. Kit of Test Specimens with Strain Gauges (basic kit)

Additional and optional Test Specimens:

(not included in the standard supply)

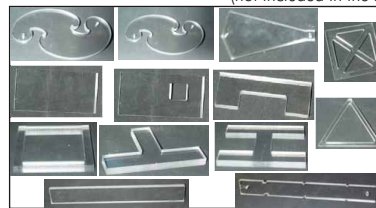

EFO-K2. Kit of Static Test Specimens (advanced kit)

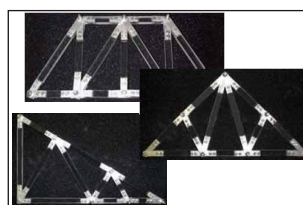

EFO-K5. Kit of Articulated Structures



EFO-K4. Kit of Test Specimens with Strain Gauges (advanced kit)

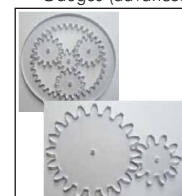

EFO-K6. Kit of Dynamic Panels

TIAC. Computer Controlled Acoustic Impedance Tube/Acoustic Insulation Test Unit

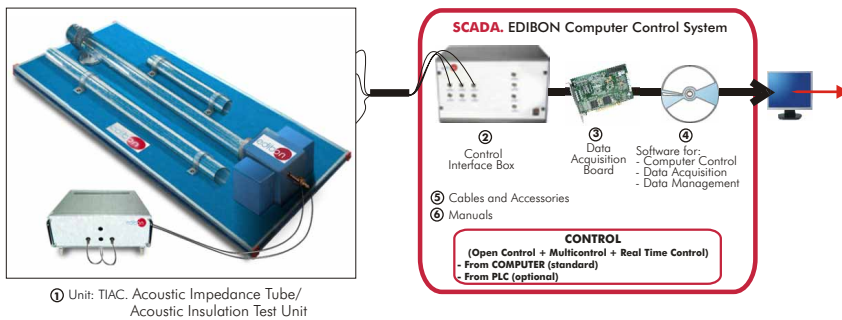
SPECIFICATIONS SUMMARY
Items supplied as standard

① TIAC. Unit:

This unit has been designed to provide students with an easy and simple method for understanding and investigating the relative acoustic properties of several materials. Anodized aluminium structure. Diagram in the front panel with similar distribution to the elements in the real unit. An acoustics standing wave unit driven by two loudspeakers and a separate console mounted power amplifier. A small microphone travelling in the transparent plastic tube allows the acoustic signal to be fed to the console mounted microphone amplifier. The transparent plastic tube combine with a scale and marker allow the microphone axial position to be measured. Wide range of tested samples allow a wide range of tests on differing materials. The units is very useful for the teaching of students in different areas as: Sound and Vibration, Mechanical, Aeronautical, Building, Health and Safety, etc.

② TIAC/CIB. Control Interface Box :

With process diagram in the front panel. The unit control elements are permanently computer controlled. Simultaneous visualization in the computer of all parameters involved in the process. Calibration of all sensors involved in the process. Real time curves representation. All the actuators' values can be changed at any time from the keyboard. Shield and filtered signals to avoid external interferences. Real time control with flexibility of modifications from the computer keyboard of the parameters, at any moment during the process. Open control allowing modifications, at any time and in a real time, of parameters involved in the process. 3 safety levels: mechanical in the unit, electronic in control interface, and the third one in the control software.

③ DAB. Data Acquisition Board:

PCI Data acquisition National Instruments board to be placed in a computer slot. 16 Analog inputs. Sampling rate up to: 250 KS/s. 2 Analog outputs. 24 Digital Inputs/Outputs.

④ TIAC/CCSOF. Computer Control + Data Acquisition + Data Management Software:

Flexible, open and multicontrol software. Management, processing, comparison and storage of data. Sampling velocity up to 250,000 data per second. It allows the registration of the alarms state and the graphic representation in real time.

⑤ Cables and Accessories, for normal operation.

⑥ Manuals: This unit is supplied with 8 manuals.

Dimensions (approx.) = Unit: 1500 x 500 x 200 mm. Weight: 10 Kg.

Control Interface : 490 x 330 x 310 mm. Weight: 10 Kg.

More information in: www.edibon.com/products/catalogues/en/units/mechanicsmaterials/building/TIAC.pdf

PRACTICAL POSSIBILITIES

- 1.- Study and investigation of the relative acoustic properties of different materials.
- 2.- Determination of the sound absorption coefficient for many of the normal building lining materials such as carpet, cork, fibre board and many of the better acoustic attenuating materials.
- 3.- To determine the speed of sound in air at ambient temperature and comparison of this with the calculated value.
- 4.- Determine the sound absorption coefficient of these and some poor absorbers at a range of frequencies between approximately 500 and 4000 Hz.

Other possible practices:

- 5.- Sensors calibration.
- 6-24.- Practices with PLC

TDRC. Computer Controlled Noise Control Demonstration Unit

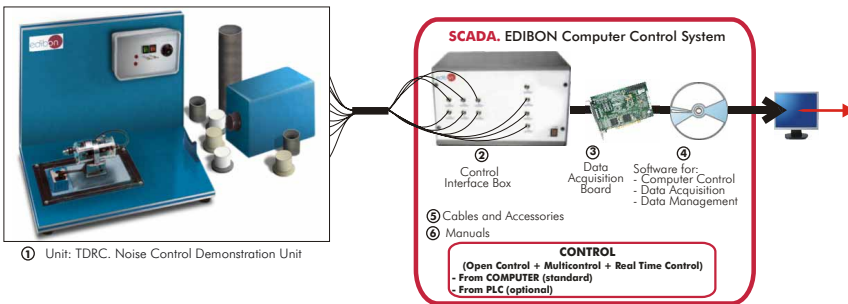
SPECIFICATIONS SUMMARY
Items supplied as standard

① TDRC. Unit:

Self-contained unit for the demonstration of the methods of noise and vibration control. Anodized aluminium structure. Diagram in the front panel with similar distribution to the elements in the real unit. Integral 240 V. electric motor and gear box together with a fan (12 V.) unit provide two noise sources. Variable control of both voltage sources allows speed control of both motors.

A rigid reinforced enclosure with acoustic lining may be placed over either noise source attachments allow investigation of sound attenuation in ducts. Openings in both ends of the box allow demonstration of the effects of small holes in the enclosure and the transmission of mechanical and aerodynamically generated noise along ducts.

Two microphones are provided, one fixed adjacent to the noise source and the other mounted on the wand that may be moved around over the unit. Each of the two microphones may be connected to a dBA filter and amplifier that illuminates a bar display in the panel, to show relative loudness levels. Resilient mountings and mount bypass equipment. These allow study variation of vibration modes at various frequencies and transmission of noise through solids.

② TDRC/CIB. Control Interface Box :

With process diagram in the front panel. The unit control elements are permanently computer controlled. Simultaneous visualization in the computer of all parameters involved in the process. Calibration of all sensors involved in the process. Real time curves representation. All the actuators' values can be changed at any time from the keyboard. Shield and filtered signals to avoid external interferences. Real time control with flexibility of modifications from the computer keyboard of the parameters, at any moment during the process. Open control allowing modifications, at any time and in a real time, of parameters involved in the process. 3 safety levels: mechanical in the unit, electronic in control interface, and the third one in the control software.

③ DAB. Data Acquisition Board:

PCI Data acquisition National Instruments board to be placed in a computer slot. 16 Analog inputs. Sampling rate up to: 250 KS/s. 2 Analog outputs. 24 Digital Inputs/Outputs.

④ TDRC/CCSOF. Computer Control + Data Acquisition + Data Management Software:

Flexible, open and multicontrol software. Management, processing, comparison and storage of data. Sampling velocity up to 250,000 data per second. It allows the registration of the alarms state and the graphic representation in real time.

⑤ Cables and Accessories, for normal operation.

⑥ Manuals: This unit is supplied with 8 manuals.

Dimensions (approx.) = Unit: 950 x 600 x 410 mm. Weight: 40 Kg. Control Interface: 490 x 330 x 310 mm. Weight: 10 Kg.

More information in: www.edibon.com/products/catalogues/en/units/mechanicsmaterials/building/TDRC.pdf

PRACTICAL POSSIBILITIES

- 1.- Demonstration of noise and vibration control.
- 2.- Attenuation of mechanical or aerodynamic noise source using a rigid enclosure and combining this with an absorbent acoustic lining.
- 3.- Rapid degeneration in effectiveness of the enclosure method, due to minor imperfections in construction.
- 4.- The transmission of noise along ducts and methods of attenuation using acoustic linings.
- 5.- The transmission of noise along solid paths and the methods of reduction by isolation.
- 6.- Rigid body modes of vibration of a resiliently mounted source and the effects of mass variation on the resonant frequencies and modes of vibration.
- 7.- The effect of the noise frequency on the effectiveness of attenuation methods.

Other possible practices:

- 8.- Sensors calibration.
- 9-27.- Practices with PLC.

TEVC. Computer Controlled Ventilation Trainer

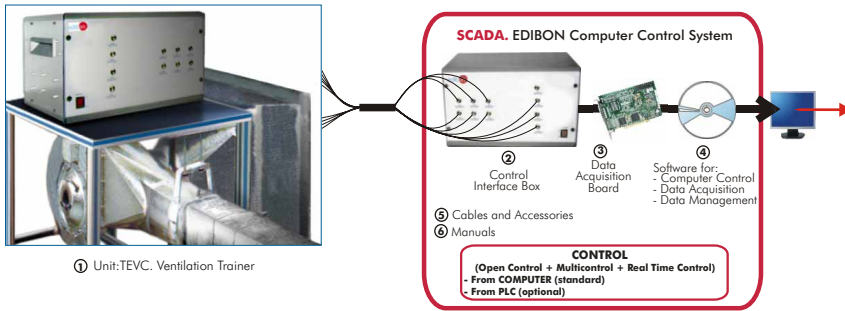

① Unit: TEVC. Ventilation Trainer

SPECIFICATIONS SUMMARY
Items supplied as standard

① TEVC. Unit:

This ventilation training unit enables students to study basic airflow and fluid mechanics as well as process of commissioning and balancing a multiducted air distribution system.

Metallic structure. Diagram in the front panel with similar distribution to the elements in the real unit.

Variable speed centrifugal fan, computer controlled. Rectangular air intake and filter holder.

The fan discharges into a 200 mm diameter steel duct and this connects to distribution ductwork. Connections and ductwork are manufactured in steel and may be connected in different forms. The ductwork is supported from air distribution isolation mounts hung on steel pedestals linked together.

Necessary components are supplied with the unit to enable parallel branch and line balancing experiments to be undertaken.

Air power supply points are provide that may be balanced on the assembled unit to supply a range of airflows. Pressure sensors. Flow sensors. Pitot static tube.

② TEVC/CIB. Control Interface Box:

With process diagram in the front panel. The unit control elements are permanently computer controlled. Simultaneous visualization in the computer of all parameters involved in the process. Calibration of all sensors involved in the process. Real time curves representation. All the actuators' values can be changed at any time from the keyboard. Shield and filtered signals to avoid external interferences. Real time control with flexibility of modifications from the computer keyboard of the parameters, at any moment during the process. Open control allowing modifications, at any moment and in real time, of parameters involved in the process. 3 safety levels: mechanical in the unit, electronic in the control interface, and the third one in the control software.

③ DAB. Data Acquisition Board:

PCI Data acquisition National Instruments board to be placed in a computer slot. 16 Analog inputs. Sampling rate up to: 250 KS/s. 2 Analog outputs. 24 Digital Inputs/Outputs.

④ TEVC/CCSOF. Computer Control+Data Acquisition+Data Management Software:

Flexible, open and multicontrol software. Management, processing, comparison and storage of data. Sampling velocity up to 250,000 data per second. It allows the registration of the alarms state and the graphic representation in real time.

⑤ Cables and Accessories, for normal operation.

⑥ Manuals: This unit is supplied with 8 manuals.

Dimensions (approx.) = Unit: 1000x 3000x 2000 mm. Weight: 300 Kg. Control Interface: 490 x 330 x 310 mm. Weight: 10 Kg.

More information in: www.edibon.com/products/catalogues/en/units/mechanicsmaterials/building/TEVC.pdf

PRACTICAL POSSIBILITIES

- 1.- Examination of typical components, fabrication, installation and assembly techniques used in air handling systems.
- 2.- Investigation of pressure losses in beds, branches, changes of section and over straight lengths of duct, together with the variation in pressure drop with velocity.
- 3.- Measurement of air flow rate using pitot-static traverse, orifice pressure differential and anemometer methods.
- 4.- Examination of standard types of panel air bag filters and their pressure drop against face velocity.
- 5.- Determination of the "k" factor for the pressure loss of the above components in each particular configuration.
- 6.- Investigation of the fan pressure and volume flow characteristics at various supply voltages.
- 7.- Balancing of air flow distribution in a series or two branch parallel distribution system using either main damper or fan speed flow control.
- 8.- Allows an additional parallel branch and two diffusers to be investigated.
- 9.- Addition of the ductwork leakage test set allows students to carry out commissioning leak testing on the above components.
- 10.- Allows an additional tee branch and two diffusers to be investigated.
- 11.- Sensors calibration.
- 12-30.- Practices with PLC.

TCMC. Computer Controlled Thermal Conductivity of Building and Insulating Materials Unit

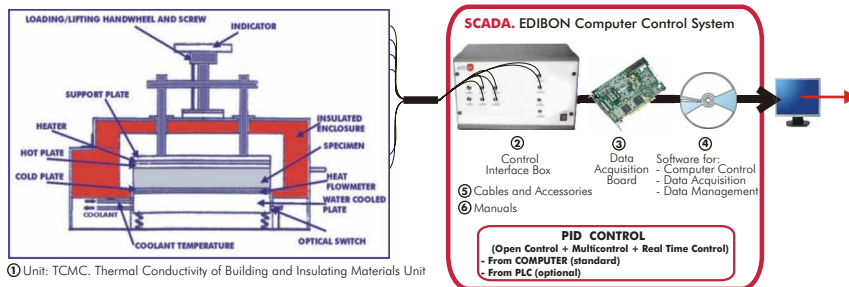

① Unit: TCMC. Thermal Conductivity of Building and Insulating Materials Unit

SPECIFICATIONS SUMMARY
Items supplied as standard

① TCMC. Unit:

Unit for determination of thermal conductivity of building and other insulating materials.

Anodized aluminium structure and panels in painted steel. Diagram in the front panel.

Measurement of thermal conductivity for materials with thermal resistance in the range 0.1 to 1.4 m² K/W at mean temperatures up to 50° C. Suitable for sheet, fibrous, granular and cellular materials. Suitable for soft, rigid, and semi-rigid materials up to 5kg sample weight. Suitable for homogeneous and non-homogeneous materials.

Specimens size: 300 x 300 mm and up to 75 mm of thicknesses.

Thermal performance of single layer and composite materials of various thicknesses up to 75 mm. Insulated enclosure. Electric heater. Height adjustable 500W hot plate, controlled. Water-cooled cold plate. Loading/lifting handwheel and screw. Optical switch under the cold plate senses the compression of loading springs to ensure that a consistent pressure is applied to the specimen. Heat flow sensor, fitted to cold plate. Temperature sensors. A set of specimens, 8 pieces.

② TCMC/CIB. Control Interface Box:

With process diagram in the front panel. The unit control elements are permanently computer controlled. Simultaneous visualization in the computer of all parameters involved in the process. Calibration of all sensors involved in the process. Real time curves representation. All the actuators' values can be changed at any time from the keyboard. Shield and filtered signals to avoid external interferences. Real time PID control with flexibility of modifications from the computer keyboard of the PID parameters, at any moment during the process. Open control allowing modifications, at any moment and in real time, of parameters involved in the process. 3 safety levels: mechanical in the unit, electronic in the control interface, and the third one in the control software.

③ DAB. Data Acquisition Board:

PCI Data acquisition National Instruments board to be placed in a computer slot. 16 Analog inputs. Sampling rate up to: 250 KS/s. 2 Analog outputs. 24 Digital Inputs/Outputs.

④ TCMC/CCSOF. PID Computer Control+Data Acquisition+Data Management Software:

Flexible, open and multicontrol software. Management, processing, comparison and storage of data. Sampling velocity up to 250,000 data per second. It allows the registration of the alarms state and the graphic representation in real time.

⑤ Cables and Accessories, for normal operation.

⑥ Manuals: This unit is supplied with 8 manuals.

Dimensions (approx.) = Unit: 950 x 700 x 500 mm. Weight: 60 Kg. Control Interface: 490 x 330 x 310 mm. Weight: 10 Kg.

More information in: www.edibon.com/products/catalogues/en/units/mechanicsmaterials/building/TCMC.pdf

PRACTICAL POSSIBILITIES

- 1.- Determination of the thermal conductivity of different materials.
 - 2.- Determination of the thermal resistance.
 - 3.- Thermal conductivity of several specimens connected in series.
 - 4.- Industrial research capability.
- Other possible practices:
- 5.- Sensors calibration.
 - 6-24.- Practices with PLC.

Specifications subject to change without previous notice, due to the convenience of improvements of the product.



edibon
INTERNATIONAL

C/ Del Agua, 14.
Polígono Industrial San José de Valderas.
28918 Leganés (Madrid). SPAIN.
Phone +34 91 619 93 63
Fax +34 91 619 86 47
edibon@edibon.com
www.edibon.com

REPRESENTATIVE:

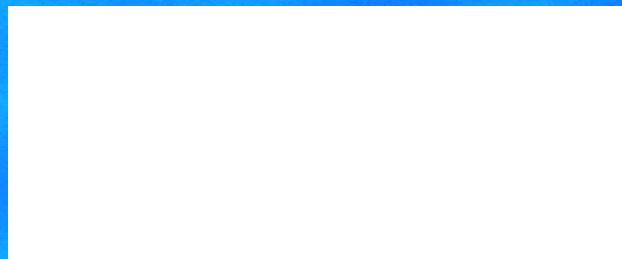

ISO 9000: Quality Management
(for Design, Manufacturing,
Commercialization and After-sales service)



European Union Certificate
(total safety)



Certificates ISO 14000 and
ECO-Management and Audit Scheme
(environmental management)



Worlddidac Quality Charter
Certificate
(Worlddidac Member)