

Catalog 2012B
New Product
Additions

PE PASTERNAK



The Broadest Selection of RF & Microwave Components
and Assemblies Available for Same-Day Shipping...

Over 40 Years!



www.pasternack.com



866-727-8376



NEW PRODUCT ADDITIONS

New Low PIM Products from Pasternack



Low PIM Cable Assemblies

Pasternack Enterprises' new 1/2" coaxial jumpers are used on many RF communications applications that benefit from low PIM. Examples of these applications include tower top jumpers, shelter/cabinet jumpers, antenna feed lines and 2-way land mobile radio installations. The new 1/2" corrugated coax jumpers from Pasternack are perfect for runs when, low PIM, low VSWR, low insertion loss, and/or RF Isolation are critical. Our coaxial jumpers are 100% RF tested for PIM and VSWR, ensuring optimum installed performance.

See Page 9 for Cable Assembly Products

Low PIM Connectors

The new low passive intermodulation (PIM) connectors from Pasternack are designed for ease of installation in the field while providing outstanding electrical and mechanical performance. These connectors are ideal for installations where custom length coaxial cable jumpers are needed to provide low PIM levels and outstanding RF performance. Pasternack's new lines of low PIM connectors are perfect for building custom assemblies using our low PIM coaxial cable jumpers.

See Page 78 for Connector Products

Low PIM Adapters

The new low PIM adapters from Pasternack are perfect for applications requiring high performance at ultra low VSWR. Pasternack's new line of precision low PIM adapters is ideal for portable PIM testing and portable sweep testing. Other low PIM adapter applications include installations in cellular/PCS, RF wireless infrastructure, OEM in-rack RF routing, in-building systems, and land mobile radio. Pasternack's new lines of low PIM adapters mate perfectly to our low PIM coaxial cable jumpers.

See Page 137 for Adapter Products

PRECISION CONNECTORS



Pasternack Enterprises' precision connectors are designed to fit onto 086 and 141 type semi-rigid and formable cable. These connectors are available in multiple connector types including SMA, N, TNC, MCX and MMCX type precision connectors. Frequency ratings for these RF connectors range from 6 GHz to 18 GHz depending on type and style.

See Page 78 for Connectors

See Our Website For Real-Time Stock Availability!



Free Freight Available
via UPS Ground
to USA & Canada



Real-Time Stock
Levels & Pricing
On Our WebSite



Toll-Free Technical
Support
(866) 727-8376



Same-Day Shipping,
Even Custom
Cable Assemblies

NEW PRODUCT ADDITIONS

HIGH FREQUENCY ATTENUATORS

Pasternack has recently added 1 Watt 2.4mm and 2.92mm attenuators with operating frequencies up to 50 GHz. These attenuators have stainless steel bodies with anti-torque flats to assist in the application of proper torque during mating of the connectors. The 40 GHz 2.92mm attenuators are available in 1 db increments from 1 to 10 db as well as 12, 15, 20 and 30 db attenuation values. The 50 GHz, 2.4mm version is available in the following attenuation values: 3, 6, 10, 15, 20 and 30 db.

See Page 185 for Attenuator Products



HIGH FREQUENCY TERMINATIONS

Pasternack's new terminations (RF loads) include 1 Watt 40 and 50 GHz versions. They are available with 2.92mm and 2.4mm connector options with male and female interfaces. We have also added a 2 Watt 40 GHz termination with 2.92mm connectors. The Male versions of these terminations are available with and without retaining chains.

See Page 195 for Termination Products



FILTERS

Pasternack introduces its new line of low pass and high pass filters to compliment our broad line of bandpass filters. Our filters cover a frequency range from 30 MHz to 5.9 GHz, and the Compline design results in Low Insertion Loss performance. Suitable for the following bands:

- ISM
- RFID
- WiFi
- Bluetooth
- Zigbee
- GPS
- GSM
- PCS
- UMTS
- AWS
- WIMAX
- Military Communications

See Page 207 for Filters



Low Pass



High Pass

See Our Website For Real-Time Stock Availability!

Coaxial Cable Assemblies Selection Guide

Do you need a cable assembly that isn't in our catalog?
 Visit our website to view our entire selection of available assemblies or
 to build your own custom length cable assembly!

3 Easy Ways to Find your Product.....

1. Search by PE Part Number

If you know the PE part number you are searching for, please reference our Part Number Index on Page 253.

2. Quick Reference Guide

See pages 10-11 for our **Cable Assemblies Matrix**.

(Page number refers to first appearance of product in the Cable Assemblies Section)

Cable Connector	Page	Cable Connector	Page	Cable Connector	Page	Cable Connector	Page	Cable Connector	Page
Precision Cable Assembly		2.92mm	45	HN	58	QN	51	SMC-50 Ohm	39
1.85mm	23	3.5mm	45	LC	58	RCA-75 Ohm	71	SMC-75 Ohm	70
2.4mm	23	3/4"-20 Twinax	73	MC-Card	41	Reverse Polarity SMA	34	SMP	39
2.92mm	17	7/16 DIN	50	MCX	44	Reverse Polarity TNC	39	SSMA	36
3.5mm	16	Alligator Clips	67	MHV	68	Reverse Thread SMA	45	SSMB	59
MCX	25	Banana Plug	67	Miniature Alligator Clips	67	Safety Hooks	68	Tip Plugs	68
MMCX	25	BNC-50 Ohm	41	Miniature Banana Plugs	68	SC	58	Standard Banana Plugs	67
N	15	BNC-75 Ohm	69	Mini SMB-75 Ohm	71	SHV	68	TNC-50 Ohm	38
SMA	15	BNC Twinax	73	Mini UHF	51	Single Wire Patch Cords	73	TNC-75 Ohm	69
TNC	15	Breakouts	76	MMCX	40	SMA	30	UHF	55
Standard Cable Assembly		C	69	N-50 Ohm	36	SMB-50 Ohm	40	UMCX	39
1.85mm	45	FAKRA	40	N-75 Ohm	69	SMB-75 Ohm	71	Unterminated Wires	68
10-32	57	FME	56	QMA	39				
2.4mm	36	GR874	64						

3. Cable Assembly Locator

(Cable Assembly Locator on Page 12-13 to locate the Cable Assembly you need by either connector end.)



SMA Female Bulkhead to MCX Plug Right Angle
 PE39421-12

SMA FEMALE BULKHEAD TO:	EXAMPLE
MCX PLUG RIGHT ANGLE	23
MMCX PLUG RIGHT ANGLE	23
SMA FEMALE BULKHEAD	43
SMA MALE	17,23,31,32
SMA MALE RIGHT ANGLE	17,23,40,41
UMCX PLUG	76

MCX PLUG RIGHT ANGLE TO:	EXAMPLE
MCX PLUG	78
MCX PLUG RIGHT ANGLE	79
N FEMALE BULKHEAD	25
SMA FEMALE BULKHEAD	23
TNC FEMALE BULKHEAD	27
UMCX PLUG	76

The Cable Assembly Locator example above includes Between-Series Cable Assembly part numbers in two configurations:
Connector 1 to Connector 2 as well as Connector 2 to Connector 1 will be found in the same location.

Products can only be found under the first instance of the series combination. As an example, PE39421-12 above will be found in only one location in the Cable Assembly Section.

All Pasternack coaxial cable assembly part number indicate the length of the assembly (in inches) following the hyphen.
 Example: PE300-24 and PE300-26.5 are 24 inches and 26.5 inches in length respectively

NOTE: All cable assemblies have a length tolerance of 1.5% or $\pm 3/8"$, whichever is greater.

Cable Assemblies Matrix

Additional configurations can be found on our website.

Cable Assemblies

Connectors	1.65.6 75 Ohm	1.85mm	1032	2.4mm	2.92mm	3.5mm	3.5mm NMD	3/4"- 20	7/16 DIN	Alligator	Banana	BNC 75 Ohm	BNC	BNC Twinax	C	F 75 Ohm	FAKRA	FC (FO)	FME	GR874	HDMI 75 Ohm	HN	Hook	LC (FO)	LC	MCCard	MCX	MHV	Mini Alligator	Mini Banana	Mini SMB 75 Ohm	
1.65.6 75 Ohm	W											71	W																			
1.85mm		46		46	45	W																										
1032			57										57																			
2.4mm		46		45	45																											
2.92mm		45		45	45																											
3.5mm		W				45																										
3.5mm NMD																																
3/4"- 20								73																								
7/16 DIN									55																							
Alligator										74	73	67																				
Banana										73	73	67																	74			
BNC 75 Ohm	71											72				70																71
BNC	W		57							67	67	64			W				56	64			68					67	68	W		
BNC Twinax													73																			
C														69																		
F 75 Ohm											70	W			70																	
FAKRA																	63															
FC (FO)																																
FME													56						56													
GR874												64								64												
HDMI 75 Ohm																						W										
HN																							58									
Hook												68																				
LC (FO)																																
LC																									58							
MCCard																											W					
MCX																												60				
MHV																													68			
Mini Alligator											74	67																	75			
Mini Banana												68																				
Mini SMB 75 Ohm											71	W																				71
Mini UHF																																
MMCX												60																				
MTRJ (FO)																																
N 75 Ohm											69																					
N								50				51									W							52				
NMO Mount												68							56													
Open																																
QMA																																
QN																																
RCA 75 Ohm																																
SC (FO)																																
SC																																
SHV																														68		
SMA		W		36					W			41				40											41	44				
SMB 75 Ohm												71																				
SMB													62																			
SMC 75 Ohm												70																				
SMC													57																			
SMP																																
Spade										74	74																					
SSMA																																
SSMB																																
ST (FO)																																
Tip													68																			
TNC 75 Ohm												69																				
TNC													54																54			
TOSLINK																																
UHF											W	55																				
UMCX																			56									59				
Unterminated Lead												68																				
VF45 (FO)																																

W = See Website

ROHS & REACH COMPLIANT. CUSTOM-LENGTH CABLE ASSEMBLIES MAY BE ORDERED ON OUR WEBSITE.

Visit Our Website for More Information. We Build Custom Cables.
Notes: Cable assembly max frequency may be lower than connector or coax max frequency

Cable Assemblies Matrix

Additional configurations can be found on our website.

Connectors	Mini UHF	MMCX	MTRJ (FO)	N 75 Ohm	N	NMO Mount	Open	QMA	QN	RCA 75 Ohm	SC (FO)	SC	SHV	SMA	SMB 75 Ohm	SMB	SMC 75 Ohm	SMC	SMP	Spade	SSMA	SSMB	ST (FO)	Tip	TNC 75 Ohm	TNC	TOSLINK	UHF	UMCX	Unterminated Lead	VF45 (FO)
1.65.6 75 Ohm																															
1.85mm														W																	
1032																															
2.4mm														36																	
2.92mm																															
3.5mm																															
3.5mm NMD																															
3/4" - 20																															
7/16 DIN					50									W																	
Alligator																					74										
Banana																					74								W		
BNC 75 Ohm				69											71		70									69					
BNC		60			51	68								41		62		57							68		54		55		68
BNC Twinax																															
C																															
F 75 Ohm																															
FAKRA														40																	
FC (FO)																															
FME						56																								56	
GR874					W																										
HDMI 75 Ohm																															
HN																															
Hook																															
LC (FO)																															
LC																															
MCCard															41																
MCX					52										44											54			59		
MHV													68																		
Mini Alligator																															
Mini Banana																															
Mini SMB 75 Ohm																															
Mini UHF	56				51	W								W																	
MMCX		59			52										40											54			59		
MTRJ (FO)																															
N 75 Ohm				69																											
N	51	52			46	52			51					36												50		W	51		
NMO Mount	W				52									42												W					
Open																														59	
QMA								58							39																
QN					51				58																						
RCA 75 Ohm										71																					
SC (FO)																															
SC												58																			
SHV													69																		
SMA	W	40			36	42	39							30		40		39	39							38			39		
SMB 75 Ohm															71																
SMB														40		61															
SMC 75 Ohm																	70														
SMC														39				56									W			57	
SMP														39						58											
Spade																															
SSMA														36									46								
SSMB																								63						59	
ST (FO)																															
Tip																															
TNC 75 Ohm																										69					
TNC		54			50	W								38					W								52			54	
TOSLINK																															
UHF					W																									55	
UMCX		59			51		59							39												54				59	
Unterminated Lead																															
VF45 (FO)																															

W = See Website

Cable Assemblies

Visit Our Website for More Information. We Build Custom Cables. Notes: Cable assembly max frequency may be lower than connector or coax max frequency

 Free Freight Available via UPS Ground to USA & Canada

 Real-Time Stock Levels & Pricing On Our WebSite

 Toll-Free Technical Support (866) 727-8376

 Same-Day Shipping, Even Custom Cable Assemblies

Cable Assembly Locator

Connector Type	Page
1.85mm MALE	
1.85mm MALE	23, 46
2.4mm MALE	23, 46
2.92mm MALE	23, 45
10-32 MALE	
10-32 MALE	57
10-32 MALE RIGHT ANGLE	57
BNC MALE	57
10-32 MALE RIGHT ANGLE	
10-32 MALE	57
2.4mm FEMALE	
2.4mm MALE	46
2.4mm MALE	
1.85mm MALE	23, 46
2.4mm FEMALE	46
2.4mm MALE	23, 45
2.92mm MALE	23, 45
SMA MALE	36
2.92mm FEMALE	
2.92mm MALE	45
2.92mm FEMALE BULKHEAD	
2.92mm MALE	45
2.92mm MALE	
1.85mm MALE	23, 45
2.4mm MALE	23, 45
2.92mm FEMALE	45
2.92mm FEMALE BULKHEAD	45
2.92mm MALE	17, 23, 45
2.92mm FEMALE	17
2.92mm FEMALE	
2.92mm MALE	17
3.5mm FEMALE	
3.5mm MALE	16, 45
3.5mm FEMALE	
3.5mm MALE	45
3.5mm MALE	
3.5mm FEMALE	16, 45
3.5mm FEMALE	45
3.5mm MALE	16, 45
3/4" - 20 MALE	
3/4"-20 MALE	73
7/16 DIN FEMALE	
7/16 DIN MALE	55
7/16 DIN MALE	
7/16 DIN FEMALE	55
7/16 DIN MALE	55
7/16 DIN MALE RIGHT ANGLE	55
N MALE	50
7/16 DIN MALE RIGHT ANGLE	
7/16 DIN MALE	55
75 OHM 1.6/5.6 PLUG	
75 OHM BNC MALE	71
75 OHM BNC FEMALE	
75 OHM BNC FEMALE	73
75 OHM BNC MALE	72
75 OHM BNC FEMALE BULKHEAD	
75 OHM BNC MALE	72
75 OHM BNC MALE	
75 OHM 1.6/5.6 PLUG	71
75 OHM BNC FEMALE	72
75 OHM BNC FEMALE BULKHEAD	72
75 OHM BNC MALE	72
75 OHM BNC MALE RIGHT ANGLE	72
75 OHM F MALE	70
75 OHM MINI SMB PLUG	71
75 OHM N MALE	69
75 OHM SMB PLUG	71
75 OHM SMC PLUG	70
75 OHM TNC MALE	69

Connector Type	Page
75 OHM BNC MALE RIGHT ANGLE	
75 OHM BNC MALE	72
75 OHM BNC MALE RIGHT ANGLE	73
75 OHM F MALE	
75 OHM BNC MALE	70
75 OHM F MALE	70
75 OHM F MALE RIGHT ANGLE	70
75 OHM F MALE RIGHT ANGLE	
75 OHM F MALE	70
75 OHM MCX JACK	
N FEMALE BULKHEAD	52
SMA FEMALE BULKHEAD	44
TNC FEMALE BULKHEAD	54
75 OHM MCX PLUG	
UMCX PLUG	59
75 OHM MINI SMB PLUG	
75 OHM BNC MALE	71
75 OHM MINI SMB PLUG	71
75 OHM MINI SMB PLUG RIGHT ANGLE	71
75 OHM MINI SMB PLUG RIGHT ANGLE	
75 OHM MINI SMB PLUG	71
75 OHM MINI SMB PLUG RIGHT ANGLE	71
75 OHM N MALE	
75 OHM BNC MALE	69
75 OHM N MALE	69
75 OHM RCA FEMALE BULKHEAD	
75 OHM RCAMALE	71
75 OHM RCA MALE	
75 OHM RCA FEMALE BULKHEAD	71
75 OHM SMB PLUG	
75 OHM BNC MALE	71
75 OHM SMB PLUG	71
75 OHM SMC PLUG	
75 OHM BNC MALE	70
75 OHM SMC PLUG	70
75 OHM TNC MALE	
75 OHM BNC MALE	69
75 OHM TNC MALE	69
ALLIGATOR CLIP	
ALLIGATOR CLIP	74
BANANA PLUG	73
BNC MALE	67
SPADE LUG	74
BANANA PLUG	
ALLIGATOR CLIP	73
BANANA PLUG	73
BNC MALE	67
MINI ALLIGATOR CLIP	74
SPADE LUG	74
BNC FEMALE	
BNC FEMALE	67
BNC MALE	66
NMO MOUNT CONNECTOR	68
BNC FEMALE BULKHEAD	
BNC MALE	66
MMCX PLUG RIGHT ANGLE	60
BNC MALE	
10-32 MALE	57
ALLIGATOR CLIP	67
BANANA PLUG	67
BNC FEMALE	66
BNC FEMALE BULKHEAD	66
BNC MALE	64
BNC MALE RIGHT ANGLE	65
FME JACK	56
GR874	64
HOOK	68
MINI ALLIGATOR CLIP	67
MINI BANANA PLUG	68
N MALE	51
NMO MOUNT CONNECTOR	68

Connector Type	Page
REVERSE POLARITY SMA MALE	44
REVERSE POLARITY TNC MALE	54
SMA MALE	41
SMA MALE RIGHT ANGLE	42
SMB PLUG	62
SMC PLUG	57
TIP PLUG	68
TNC MALE	54
UHF MALE	55
UNTERMINATED LEAD	68
BNC MALE RIGHT ANGLE	
BNC MALE	65
BNC MALE RIGHT ANGLE	66
BNC TWINAX PLUG	
BNC TWINAX PLUG	73
BREAKOUTS	
BREAKOUTS	76
C MALE	
C MALE	69
FAKRA JACK	
FAKRA JACK	64
FAKRA PLUG	63
SMA FEMALE	43
SMA MALE	41
FAKRA JACK RIGHT ANGLE	
FAKRA PLUG	64
FAKRA PLUG	
FAKRA JACK	63
FAKRA JACK RIGHT ANGLE	64
FAKRA PLUG	63
SMA FEMALE	43
SMA MALE	40
FME JACK	
BNC MALE	56
FME JACK	56
NMO MOUNT CONNECTOR	56
FME JACK BULKHEAD	
UMCX PLUG	56
FME PLUG	
NMO MOUNT CONNECTOR	56
GR874	
BNC MALE	64
GR874	64
HN MALE	
HN MALE	58
HOOK	
BNC MALE	68
LC MALE	
LC MALE	58
MC-CARD PLUG	
SMA MALE	41
MCX JACK BULKHEAD	
UMCX PLUG RIGHT ANGLE	59
MCX PLUG	
MCX PLUG	60
MCX PLUG RIGHT ANGLE	60
UMCX PLUG RIGHT ANGLE	59
MCX PLUG RIGHT ANGLE	
MCX PLUG	60
MCX PLUG RIGHT ANGLE	60
TNC FEMALE BULKHEAD	29, 54
UMCX PLUG RIGHT ANGLE	59
MCX PLUG RIGHT ANGLE	
N FEMALE BULKHEAD	27, 52
SMA FEMALE BULKHEAD	25, 44
TNC FEMALE BULKHEAD	29, 54
MHV MALE	
MHV MALE	68
SHV PLUG	68

Connector Type	Page
MINI ALLIGATOR CLIP	
BANANA PLUG	74
BNC MALE	67
MINI ALLIGATOR CLIP	75
MINI BANANA PLUG	
BNC MALE	68
MINI UHF MALE	
MINI UHF MALE	56
N MALE	51
MMCX PLUG	
MMCX PLUG	59
MMCX PLUG RIGHT ANGLE	60
N FEMALE BULKHEAD	27, 52
SMA FEMALE BULKHEAD	44
SMA MALE	40
MMCX PLUG RIGHT ANGLE	
BNC FEMALE BULKHEAD	60
MMCX PLUG	60
SMA FEMALE BULKHEAD	44
SMA MALE	40
TNC FEMALE BULKHEAD	29, 54
UMCX PLUG RIGHT ANGLE	59
MMCX PLUG RIGHT ANGLE	
N FEMALE BULKHEAD	27, 52
SMA FEMALE BULKHEAD	25, 44
TNC FEMALE BULKHEAD	29, 54
N FEMALE	
N MALE	27, 48
NMO MOUNT CONNECTOR	52
ON MALE	52
ON MALE RIGHT ANGLE	52
N FEMALE BULKHEAD	
N MALE	19, 21, 48
SMA MALE	19, 21, 27, 37
N FEMALE BULKHEAD	
75 OHM MCX JACK	52
MMCX PLUG	27, 52
N MALE	48
N MALE RIGHT ANGLE	49
SMA MALE	37
SMA MALE RIGHT ANGLE	42
N FEMALE BULKHEAD	
MCX PLUG RIGHT ANGLE	27, 52
MMCX PLUG RIGHT ANGLE	27, 52
N MALE	15
SMA MALE	19, 21, 27, 37
SMA MALE RIGHT ANGLE	27, 42
N MALE	
7/16 DIN MALE	50
BNC MALE	51
MINI UHF MALE	51
N FEMALE	27, 48
N FEMALE BULKHEAD	19, 21, 48
N FEMALE BULKHEAD	48
N FEMALE BULKHEAD	15
N MALE	15, 19, 21, 26, 46
N MALE RIGHT ANGLE	15, 27, 47
N MALE RIGHT ANGLE	15
NMO MOUNT CONNECTOR	52
ON MALE	51
ON MALE RIGHT ANGLE	51
REVERSE POLARITY SMA MALE	44
REVERSE POLARITY TNC MALE	50
SMA FEMALE	15, 43
SMA MALE	15, 19, 21, 36
TNC MALE	50
UMCX PLUG RIGHT ANGLE	51
N MALE RIGHT ANGLE	
N FEMALE BULKHEAD	49
N MALE	15, 27, 47
N MALE RIGHT ANGLE	49

Cable Assembly Locator

Connector Type	Page
N MALE RIGHT ANGLE	
N MALE.....	15
N MALE RIGHT ANGLE.....	15, 27
NMO MOUNT CONNECTOR	
BNC FEMALE.....	68
BNC MALE.....	68
FME JACK.....	56
FME PLUG.....	56
N FEMALE.....	52
N MALE.....	52
SMA FEMALE.....	43
SMA MALE.....	42
OPEN	
UMCX PLUG RIGHT ANGLE.....	59
PUSH ON SMA MALE	
SMA MALE.....	15, 31
QD SMA MALE	
SMA MALE.....	15, 31
QMA MALE	
QMA MALE.....	58
SMA FEMALE.....	43
SMA MALE.....	39
QN MALE	
N FEMALE.....	52
N MALE.....	51
QN MALE.....	58
QN MALE RIGHT ANGLE	
N FEMALE.....	52
N MALE.....	51
REVERSE POLARITY MCX JACK BULKHEAD	
UMCX PLUG RIGHT ANGLE.....	59
REVERSE POLARITY SMA FEMALE BULKHEAD	
UMCX PLUG RIGHT ANGLE.....	45
REVERSE POLARITY SMA MALE	
BNC MALE.....	44
N MALE.....	44
SMA MALE.....	34
TNC MALE.....	44
REVERSE POLARITY TNC FEMALE BULKHEAD	
UMCX PLUG RIGHT ANGLE.....	55
REVERSE POLARITY TNC MALE	
BNC MALE.....	54
N MALE.....	50
SMA MALE.....	39
TNC MALE.....	53
REVERSE THREAD SMA FEMALE BULKHEAD	
UMCX PLUG RIGHT ANGLE.....	45
SC MALE	
SC MALE.....	58
SHV PLUG	
MHV MALE.....	68
SHV PLUG.....	69
SMA FEMALE	
FAKRA JACK.....	43
FAKRA PLUG.....	43
N MALE.....	15, 43
NMO MOUNT CONNECTOR.....	43
QMA MALE.....	43
SMA FEMALE.....	35
SMA MALE.....	25, 32
SMA FEMALE 2 HOLE PANEL	
SMA FEMALE 2 HOLE PANEL.....	36
SMA FEMALE 4 HOLE PANEL	
SMA FEMALE 4 HOLE PANEL.....	36
SMA FEMALE BULKHEAD	
75 OHM MCX JACK.....	44
MMCX PLUG.....	44

Connector Type	Page
MMCX PLUG RIGHT ANGLE	44
SMA FEMALE BULKHEAD.....	36
SMA MALE.....	19, 25, 33
SMA MALE RIGHT ANGLE.....	35
UMCX PLUG.....	43
UMCX PLUG RIGHT ANGLE.....	44
SMA FEMALE BULKHEAD	
MCX PLUG RIGHT ANGLE.....	25, 44
MMCX PLUG RIGHT ANGLE.....	25, 44
SMA MALE.....	19
SMA MALE RIGHT ANGLE.....	19, 25, 35
SMA MALE	
2.4mm MALE.....	36
BNC MALE.....	41
FAKRA JACK.....	41
FAKRA PLUG.....	40
MC-CARD PLUG.....	41
MMCX PLUG.....	40
MMCX PLUG RIGHT ANGLE.....	40
N FEMALE BULKHEAD.....	19, 21, 27, 37
N FEMALE BULKHEAD.....	37
N FEMALE BULKHEAD.....	19, 21, 27, 37
N MALE.....	15, 19, 21, 36
NMO MOUNT CONNECTOR.....	42
PUSH ON SMA MALE.....	15, 31
QD SMA MALE.....	15, 31
QMA MALE.....	39
REVERSE POLARITY SMA MALE.....	34
REVERSE POLARITY TNC MALE.....	39
SMA FEMALE.....	25, 32
SMA FEMALE BULKHEAD.....	19, 25, 33
SMA FEMALE BULKHEAD.....	19
SMA MALE.....	15, 21, 24, 30
SMA MALE PUSH-ON.....	15, 31
SMA MALE OD.....	15, 31
SMA MALE RIGHT ANGLE.....	15, 19, 21, 25, 31
SMA MALE RIGHT ANGLE.....	15
SMB PLUG.....	40
SMC PLUG.....	39
SMP FEMALE.....	39
SSMA MALE.....	36
TNC FEMALE BULKHEAD.....	39
TNC FEMALE BULKHEAD.....	29, 39
TNC MALE.....	15, 19, 38
TNC MALE RIGHT ANGLE.....	15, 39
TNC MALE RIGHT ANGLE.....	15
UMCX PLUG RIGHT ANGLE.....	39
SMA MALE PUSH-ON	
SMA MALE.....	15, 31
SMA MALE QD	
SMA MALE.....	15, 31
SMA MALE RIGHT ANGLE	
BNC MALE.....	42
N FEMALE BULKHEAD.....	42
SMA FEMALE BULKHEAD.....	35
SMA MALE.....	15, 19, 21, 25, 31
SMA MALE RIGHT ANGLE.....	34
TNC FEMALE BULKHEAD.....	42
SMA MALE RIGHT ANGLE	
N FEMALE BULKHEAD.....	27, 42
SMA FEMALE BULKHEAD.....	19, 25, 35
SMA MALE.....	15
SMA MALE RIGHT ANGLE.....	19, 21, 25, 34
TNC FEMALE BULKHEAD.....	29, 42
SMB JACK BULKHEAD	
SMB PLUG.....	61
SMB PLUG RIGHT ANGLE.....	62
SMB PLUG	
BNC MALE.....	62
SMA MALE.....	40
SMB JACK BULKHEAD.....	61
SMB PLUG.....	61
SMB PLUG RIGHT ANGLE.....	61
SMB PLUG RIGHT ANGLE	
SMB JACK BULKHEAD.....	62

Connector Type	Page
SMB PLUG	61
SMB PLUG RIGHT ANGLE.....	62
SMC JACK BULKHEAD	
SMC PLUG.....	57
SMC PLUG RIGHT ANGLE.....	57
UMCX PLUG RIGHT ANGLE.....	57
SMC PLUG	
BNC MALE.....	57
SMA MALE.....	39
SMC JACK BULKHEAD.....	57
SMC PLUG.....	56
SMC PLUG RIGHT ANGLE.....	56
SMC PLUG RIGHT ANGLE	
SMC JACK BULKHEAD.....	57
SMC PLUG.....	56
SMC PLUG RIGHT ANGLE.....	57
SMP FEMALE	
SMA MALE.....	39
SMP FEMALE.....	58
SMP FEMALE RIGHT ANGLE.....	58
SMP FEMALE RIGHT ANGLE	
SMP FEMALE.....	58
SPADE LUG	
ALLIGATOR CLIP.....	74
BANANA PLUG.....	74
SSMA MALE	
SMA MALE.....	36
SSMA MALE.....	46
SSMB PLUG	
UMCX PLUG RIGHT ANGLE.....	59
SSMB PLUG RIGHT ANGLE	
SSMB PLUG RIGHT ANGLE.....	63
TIP PLUG	
BNC MALE.....	68
TNC FEMALE	
TNC MALE.....	29, 53
TNC FEMALE BULKHEAD	
75 OHM MCX JACK.....	54
MCX PLUG RIGHT ANGLE.....	29, 54
MMCX PLUG RIGHT ANGLE.....	29, 54
SMA MALE.....	39
SMA MALE RIGHT ANGLE.....	42
UMCX PLUG RIGHT ANGLE.....	54
TNC FEMALE BULKHEAD	
MCX PLUG RIGHT ANGLE.....	29, 54
MMCX PLUG RIGHT ANGLE.....	29, 54
SMA MALE.....	29, 39
SMA MALE RIGHT ANGLE.....	29, 42
TNC MALE	
BNC MALE.....	54
N MALE.....	50
REVERSE POLARITY SMA MALE.....	44
REVERSE POLARITY TNC MALE.....	53
SMA MALE.....	15, 19, 38
TNC FEMALE.....	29, 53
TNC MALE.....	19, 28, 52
TNC MALE RIGHT ANGLE.....	29, 53
TNC MALE RIGHT ANGLE.....	29
TNC MALE RIGHT ANGLE	
SMA MALE.....	15, 39
TNC MALE.....	29, 53
TNC MALE RIGHT ANGLE.....	53
TNC MALE RIGHT ANGLE	
SMA MALE.....	15
TNC MALE.....	29
TNC MALE RIGHT ANGLE.....	29, 53
UHF MALE	
BNC MALE.....	55
UHF MALE.....	55

Connector Type	Page
UMCX PLUG	
75 OHM MCX PLUG.....	59
FME JACK BULKHEAD.....	56
SMA FEMALE BULKHEAD.....	43
UMCX PLUG.....	59
UMCX PLUG RIGHT ANGLE	
MCX JACK BULKHEAD.....	59
MCX PLUG.....	59
MCX PLUG RIGHT ANGLE.....	59
MMCX PLUG RIGHT ANGLE.....	59
N MALE.....	51
OPEN.....	59
REVERSE POLARITY MCX JACK BULKHEAD.....	59
REVERSE POLARITY SMA FEMALE BULKHEAD.....	45
REVERSE POLARITY TNC FEMALE BULKHEAD.....	55
REVERSE THREAD SMA FEMALE BULKHEAD.....	45
SMA FEMALE BULKHEAD.....	44
SMA MALE.....	39
SMC JACK BULKHEAD.....	57
SSMB PLUG.....	59
TNC FEMALE BULKHEAD.....	54
UNTERMINATED LEAD	
BNC MALE.....	68
BREAKOUTS	
BREAKOUTS.....	76

Microwaves are classified as wavelengths ranging between one millimeter and one meter.



18 GHZ TEST CABLE ASSEMBLIES

Product Features

- Stainless Steel Connectors
- Reinforced Connector Back Shell
- Molded Strain Relief Boot
- Triple Shield Cable
- RoHS Compliant

Description

The 18 GHz test cable series offers a reinforced cable/connector interface with a molded, heavy-duty strain relief boot to minimize interface stress in demanding test environments. Its triple-shield cable design ensures excellent RF shielding of >100dB. The Right Angle connector designs utilize a swept coaxial transition for improved high frequency performance.

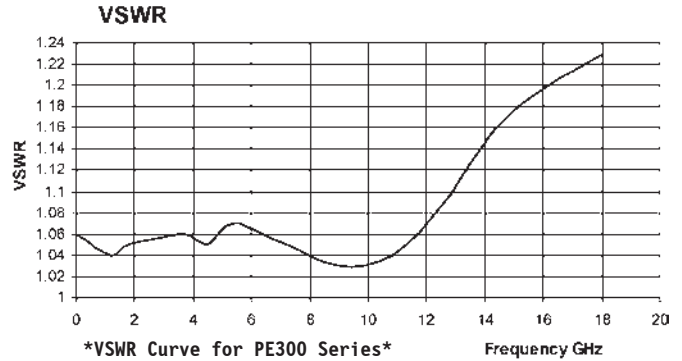
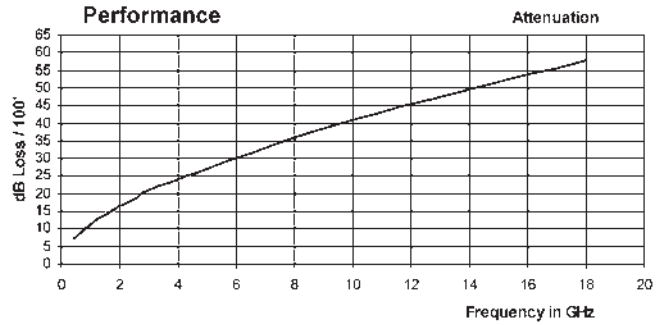

Electrical Specifications ⁽¹⁾

Parameter	Units	Value	Description
Impedance	Ohms	50Ω	
Frequency	GHz	18	
*Maximum VSWR	GHz	DC-2, 2-8, 8-18	DC-2 GHz, 1:06:1 / 2-8 GHz, 1.09:1 / 8-18 GHz, 1.4:1
Insertion Loss (Typ.)	dB/100ft	58	58 dB per 100 ft @ 18 GHz
Max Operating Voltage	V	1000	RMS
Nominal Capacitance	pF / ft.	29.4	
Velocity of Propagation	%	70	
RF Shielding	dB	<-110	Triple shield design

*See Website for detailed VSWR Specifications for each PE Part Number.











Mechanical Specifications ⁽¹⁾

Parameter	Units	Value	Description
Connector A		Stainless Steel	N, SMA, TNC
Connector B		Stainless Steel	N, SMA, TNC
Minimum Bend Radius	in. [cm]	0.75 [1.91]	
Operating Temperature	C	-55° to +125°	
Inner Conductor Diameter	in. [cm]	0.037 [.09]	Solid Silver plated Cu Clad Steel
Dielectric Diameter	in. [cm]	0.117 [.29]	Solid PTFE
Jacket Diameter	in. [cm]	0.163 [.41]	FEP

(1) Pasternack reserves the right to change specifications or information without notice.

Visit Our Website for More Information. We Build Custom Cables.
Notes: Cable assembly max frequency may be lower than connector or coax max frequency

18 GHZ TEST CABLE ASSEMBLIES

	
PE300 - SMA Male to SMA Male	PE301 - SMA Male to SMA Male Right Angle
	
PE312 - SMA Male to QD SMA Male	PE308 - SMA Male to TNC Male
	
PE304 - SMA Male to N Male	PE311 - SMA Male to Push on SMA Male
	
PE306 - SMA Female to N Male	PE302 - N Male to N Male
	
PE309 - SMA Male to TNC Male Right Angle	PE303 - N Male to N Male Right Angle

Cable Assemblies

Standard Length Pricing

P/N	Connector 1	Connector 2	Price Breaks	Length (in.)						ROW	
				-12	-24	-36	-48	-60	-72		-120
PE300	SMA Male	SMA Male	1-9	\$88.56	\$91.20	\$95.20	\$99.05	\$102.65	\$104.37	\$152.55	1
			10-24	82.36	84.82	88.54	92.12	95.46	97.06	141.87	
			25 +	76.16	78.43	81.87	85.18	88.28	89.76	131.19	
PE301	SMA Male	SMA Male Right Angle	1-9	110.70	114.00	122.51	123.72	126.97	130.26	190.55	2
			10-24	102.95	106.02	113.93	115.06	118.08	121.14	177.21	
			25 +	95.20	98.04	105.36	106.40	109.19	112.02	163.87	
PE302	N Male	N Male	1-9	124.84	128.59	133.05	137.40	142.72	145.26	162.33	3
			10-24	116.10	119.59	123.74	127.78	132.73	135.09	150.97	
			25 +	107.36	110.59	114.42	118.16	122.74	124.92	139.60	
PE303	N Male	N Male Right Angle	1-9	137.86	141.15	145.16	149.36	152.15	154.93	178.09	4
			10-24	128.21	131.27	135.00	138.90	141.50	144.08	165.62	
			25 +	118.56	121.39	124.84	128.45	130.85	133.24	153.16	
PE304	SMA Male	N Male	1-9	119.42	125.45	128.03	136.90	141.86	146.93	155.29	5
			10-24	111.06	116.67	119.07	127.32	131.93	136.64	144.42	
			25 +	102.70	107.89	110.11	117.73	122.00	126.36	133.55	
PE306	SMA Female	N Male	1-9	141.15	150.93	152.70	164.86	172.21	177.12	195.41	6
			10-24	131.27	140.36	142.01	153.32	160.16	164.72	181.73	
			25 +	121.39	129.80	131.32	141.78	148.10	152.32	168.05	
PE308	SMA Male	TNC Male	1-9	124.84	128.64	132.39	136.09	138.57	141.10	157.57	7
			10-24	116.10	119.64	123.12	126.56	128.87	131.22	146.54	
			25 +	107.36	110.63	113.86	117.04	119.17	121.35	135.51	
PE309	SMA Male	TNC Male Right Angle	1-9	142.22	146.57	150.83	155.14	157.92	160.86	184.98	8
			10-24	132.26	136.31	140.27	144.28	146.87	149.60	172.03	
			25 +	122.31	126.05	129.71	133.42	135.81	138.34	159.08	
PE311	SMA Male	Push on SMA Male	1-9	104.78	110.91	112.32	118.61	119.92	123.72	138.97	9
			10-24	97.45	103.15	104.46	110.31	111.53	115.06	129.24	
			25 +	90.11	95.38	96.60	102.00	103.13	106.40	119.51	
PE312	SMA Male	QD SMA Male	1-9	104.78	108.52	112.32	116.17	119.92	123.72	138.97	10
			10-24	97.45	100.92	104.46	108.04	111.53	115.06	129.24	
			25 +	90.11	93.33	96.60	99.91	103.13	106.40	119.51	

Visit Our Website for More Information. We Build Custom Cables.
Notes: Cable assembly max frequency may be lower than connector or coax max frequency.

 Free Freight Available via UPS Ground to USA & Canada

 Real-Time Stock Levels & Pricing On Our WebSite

 Toll-Free Technical Support (866) 727-8376

 Same-Day Shipping, Even Custom Cable Assemblies

26.5 GHZ ARMORED TEST CABLE ASSEMBLIES

Product Features

- Rugged Armored Jacket
- 1.38 Inch [3.5cm] Bend Radius
- RoHS Compliant

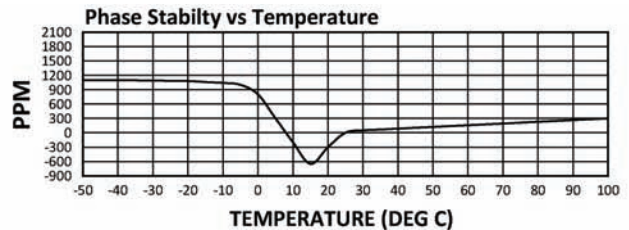
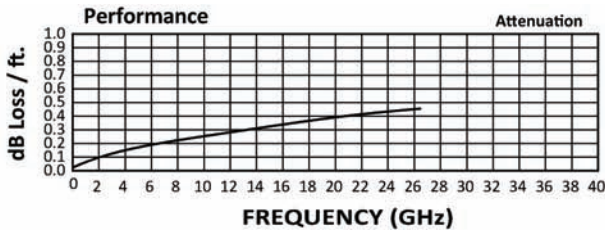

Description

The 26.5 GHz Test Cables are highly suitable for severe test environments where rugged construction is necessary, or in any location where higher phase stability is needed. Their low-loss PTFE dielectric and solid center conductor ensure low insertion loss and outstanding phase & amplitude stability. Durable Passivated Stainless Steel connectors ensure repeated secure matings, while external armoring prevents bending the cable beyond it's minimum bend radius.

Electrical Specifications ⁽¹⁾

Parameter	Units	Value	Description
Frequency Range	GHz	DC-26.5	
Impedance	Ohms	50Ω	
*Maximum VSWR	GHz	DC-10, 10-18, 18-26.5	DC-10 GHz, 1:15:1 / 10-18 GHz, 1.20:1 / 18-26.5 GHz, 1.35:1
Velocity of Propagation	%	77.0	
Max Operating Voltage	V	1000	RMS
Phase Stability	Degs	1500 PPM (Max)	from 0° C to 60° C
RF Shielding (at 1 GHz)	dB	<-100	
Power Rating (CW)	Watts	286	@ 10 GHz

*See Website for detailed VSWR Specifications for each PE Part Number.

Mechanical Specifications ⁽¹⁾

Parameter	Units	Value	Description
Minimum Bend Radius	in. [cm]	1.38 [3.51]	
Temperature Range	C	-55° to +165°	
Flex Life Bending		10,000	Min
Mating Torque	in.-lbs. [N-M]	8 [.90]	
Jacket Diameter	in. [cm]	0.47 [1.19]	Armored



PE315 - 3.5mm Male to 3.5mm Male



PE317 - 3.5mm Male to 3.5mm Female

Standard Length Pricing

P/N	Connector 1	Connector 2	Price Breaks	Length (in.)			ROW
				-24	-36	-72	
PE315	3.5mm Male	3.5mm Male	1-9	\$660.11	\$807.60	\$1,103.79	1
			10-24	613.90	751.07	1026.52	
			25 +	567.69	694.54	949.26	
PE317	3.5mm Male	3.5mm Female	1-9	700.49	809.07	1134.90	2
			10-24	651.46	752.44	1055.46	
			25 +	602.42	695.80	976.01	

Visit our website at www.Pasternack.com to see our wide selection of RF products.

(1) Pasternack reserves the right to change specifications or information without notice.

ROHS & REACH COMPLIANT. CUSTOM-LENGTH CABLE ASSEMBLIES MAY BE ORDERED ON OUR WEBSITE.

www.pasternack.com

Toll-Free: 866-727-8376

Phone: 949-261-1920

Fax: 949-261-7451

40 GHZ ARMORED TEST CABLE ASSEMBLIES

Product Features

- Rugged Armored Jacket
- 1.38 Inch [3.5cm] Bend Radius
- RoHS Compliant

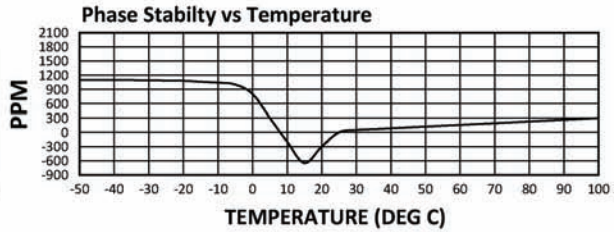
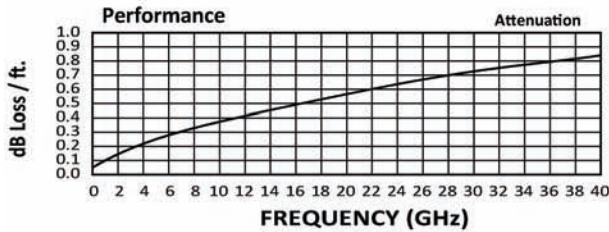

Description

The 40 GHz Test Cables are highly suitable for severe test environments where rugged construction is necessary, or in any location where higher phase stability is needed. Their low-loss PTFE dielectric and solid center conductor ensure low insertion loss and outstanding phase & amplitude stability. Durable Passivated Stainless Steel connectors ensure repeated secure matings, while external armoring prevents bending the cable beyond its minimum bend radius.

Electrical Specifications ⁽¹⁾

Parameter	Units	Value	Description
Frequency Range	GHz	DC-40	
Impedance	Ohms	50Ω	
*Maximum VSWR	GHz	DC-18, 18-26, 26-40	DC-18 GHz, 1:20:1 / 18-26 GHz, 1.25:1 / 26-40 GHz, 1.35:1
Velocity of Propagation	%	77.0	
Max Operating Voltage	V	1000	RMS
Phase Stability	Degs	1500 PPM (Max)	from 0° C to 60° C
RF Shielding (at 1 GHz)	dB	<-100	
Power Rating (CW)	Watts	150	@ 10 GHz

*See Website for detailed VSWR Specifications for each PE Part Number.

Mechanical Specifications ⁽¹⁾

Parameter	Units	Value	Description
Minimum Bend Radius	in. [cm]	1.38 [3.51]	
Temperature Range	C	-55° to +165°	
Flex Life Bending		10,000	Min
Mating Torque	in.-lbs. [N-M]	8 [.90]	
Jacket Diameter	in. [cm]	0.36 [0.91]	Armored



PE319 - 2.92mm Male to 2.92mm Male



PE321 - 2.92mm Male to 2.92mm Female

Standard Length Pricing

P/N	Connector 1	Connector 2	Price Breaks	Length (in.)			ROW
				-24	-36	-72	
PE319	2.92mm Male	2.92mm Male	1-9	\$809.07	\$961.12	\$1,417.25	1
			10-24	752.44	893.84	1318.04	
			25 +	695.80	826.56	1218.84	
PE321	2.92mm Male	2.92mm Female	1-9	863.38	1015.43	1471.56	2
			10-24	802.94	944.35	1368.55	
			25 +	742.51	873.27	1265.54	

Visit our website at www.Pasternack.com to see our wide selection of RF products.

(1) Pasternack reserves the right to change specifications or information without notice.

150 SERIES CABLE ASSEMBLIES

Product Features

- 18 GHz N & TNC, 26.5 GHz SMA
- Reinforced Coaxial Interface
- 1 Inch [2.5cm] Bend Radius
- Single Shielded Coax Cable

Description

The 26.5 GHz Flexible Cable Assembly series offer precision N & TNC connectors that operate to 18 GHz, and an SMA connector with excellent performance to 26.5 GHz. The coax provides excellent isolation and low loss performance to 26.5 GHz.

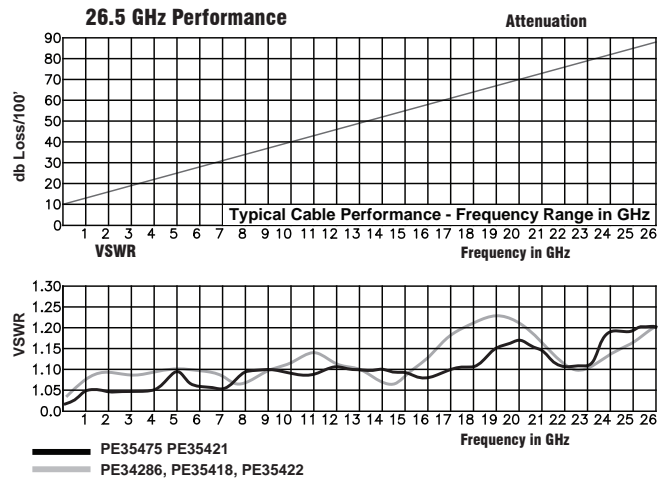
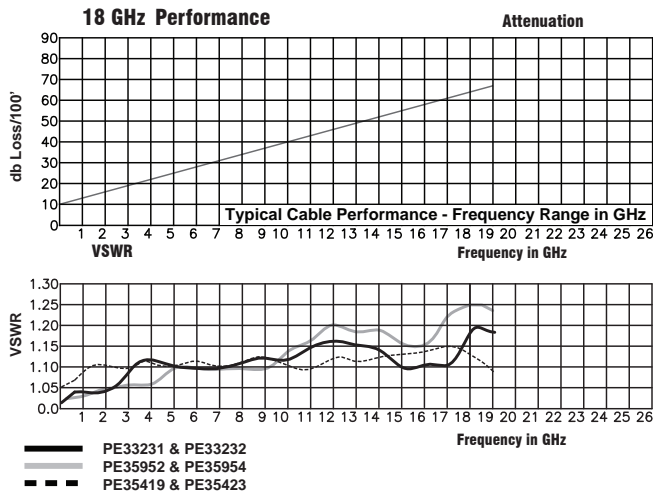

Electrical Specifications ⁽¹⁾

Parameter	Units	Value	Description
Impedance	Ohms	50Ω	
Frequency	GHz	DC to 18, 26.5	TNC & N Connector to 18 GHz, SMA to 26.5 GHz
*Maximum VSWR	GHz	DC to 12, 12-26	DC-12 GHz, 1:20:1 / 12-26 GHz, 1.30:1
Cutoff Frequency	GHz	35	
Max Operating Voltage	V	1900	RMS
Nominal Capacitance	pF / ft.	29.4	
Velocity of Propagation	%	69.5	
RF Shielding	dB	>90	

*See Website for detailed VSWR Specifications for each PE Part Number.









Mechanical Specifications ⁽¹⁾

Parameter	Units	Value	Description
Minimum Bend Radius	in. [cm]	1.0 [2.5]	
Operating Temperature	C	-50° to +205°	
Inner Conductor Diameter	in. [cm]	0.036 [.09]	Silver plated Cu Clad Steel
Dielectric Diameter	in. [cm]	0.116 [.29]	PTFE
Jacket Diameter	in. [cm]	0.150 [.38]	FEP

(1) Pasternack reserves the right to change specifications or information without notice.

150 SERIES CABLE ASSEMBLIES

See Page 246 for Mounting Holes

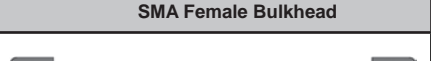
		 Mounting Hole B02
PE34286 - SMA Male to SMA Male	PE35418 - SMA Male to SMA Male R/A	PE35475 - SMA Male to SMA Female Bulkhead
	 Mounting Hole G01	
PE33231 - SMA Male to N Male	PE35954 - SMA Male to N Female Bulkhead	PE35419 - SMA Male to TNC Male
	 Mounting Hole B02	
PE35422 - SMA Male Right Angle to SMA Male Right Angle	PE35421 - SMA Male Right Angle to SMA Female Bulkhead	PE33232 - N Male to N Male
 Mounting Hole G01		For Custom Lengths or Special Configurations, Please call (949) 261-1920 or Visit www.pasternack.com
PE35952 - N Male to N Female Bulkhead	PE35423 - TNC Male to TNC Male	

Cable Assemblies

Standard Length Pricing

P/N	Connector 1	Connector 2	Freq GHz	Price Breaks	Length (in.)								ROW	
					-6	-12	-18	-24	-30	-36	-48	-60		-72
PE34286	SMA Male	SMA Male	26.5	1-24	\$61.30	\$64.40	\$67.33	\$70.42	\$73.67	\$76.55	\$82.74	\$88.87	\$94.90	1
				25-49	57.01	59.89	62.62	65.49	68.51	71.19	76.95	82.65	88.26	
				50-99	52.72	55.38	57.90	60.56	63.36	65.83	71.16	76.43	81.61	
PE35418	SMA Male	SMA Male Right Angle	26.5	1-24	106.75	110.30	113.89	117.44	121.09	124.59	131.63	142.98	145.92	2
				25-49	99.28	102.58	105.92	109.22	112.61	115.87	122.42	132.97	135.71	
				50-99	91.81	94.86	97.95	101.00	104.14	107.15	113.20	122.96	125.49	
PE35475	SMA Male	SMA Female Bulkhead	26.5	1-24	79.49	82.38	85.22	88.06	90.94	93.88	99.61	105.38	111.11	3
				25-49	73.93	76.61	79.25	81.90	84.57	87.31	92.64	98.00	103.33	
				50-99	68.36	70.85	73.29	75.73	78.21	80.74	85.66	90.63	95.55	
PE33231	SMA Male	N Male	18	1-24	79.49	82.38	85.22	88.06	90.94	93.88	99.61	105.38	111.11	4
				25-49	73.93	76.61	79.25	81.90	84.57	87.31	92.64	98.00	103.33	
				50-99	68.36	70.85	73.29	75.73	78.21	80.74	85.66	90.63	95.55	
PE35954	SMA Male	N Female Bulkhead	18	1-24	91.45	94.24	97.07	99.91	102.60	105.38	111.01	116.68	122.31	5
				25-49	85.05	87.64	90.28	92.92	95.42	98.00	103.24	108.51	113.75	
				50-99	78.65	81.05	83.48	85.92	88.24	90.63	95.47	100.34	105.19	
PE35419	SMA Male	TNC Male	18	1-24	96.01	99.30	102.50	105.69	108.93	112.07	118.40	124.99	131.27	6
				25-49	89.29	92.35	95.33	98.29	101.30	104.23	110.11	116.24	122.08	
				50-99	82.57	85.40	88.15	90.89	93.68	96.38	101.82	107.49	112.89	
PE35422	SMA Male Right Angle	SMA Male Right Angle	26.5	1-24	141.91	145.61	149.11	152.70	156.25	159.85	166.89	173.93	181.03	7
				25-49	131.98	135.42	138.67	142.01	145.31	148.66	155.21	161.75	168.36	
				50-99	122.04	125.22	128.23	131.32	134.38	137.47	143.53	149.58	155.69	
PE35421	SMA Male Right Angle	SMA Female Bulkhead	26.5	1-24	108.22	111.36	114.30	117.44	120.63	123.62	129.85	136.04	142.22	8
				25-49	100.64	103.56	106.30	109.22	112.19	114.97	120.76	126.52	132.26	
				50-99	93.07	95.77	98.30	101.00	103.74	106.31	111.67	116.99	122.31	
PE33232	N Male	N Male	18	1-24	90.74	93.78	96.77	99.86	102.85	105.84	111.87	117.95	123.93	9
				25-49	84.39	87.22	90.00	92.87	95.65	98.43	104.04	109.69	115.25	
				50-99	78.04	80.65	83.22	85.88	88.45	91.02	96.21	101.44	106.58	
PE35952	N Male	N Female Bulkhead	18	1-24	102.85	105.74	108.68	111.67	114.45	117.39	123.42	129.25	135.12	10
				25-49	95.65	98.34	101.07	103.85	106.44	109.17	114.78	120.20	125.66	
				50-99	88.45	90.94	93.46	96.04	98.43	100.96	106.14	111.16	116.20	
PE35423	TNC Male	TNC Male	18	1-24	108.22	111.36	114.30	117.44	120.58	123.62	129.85	136.04	142.22	11
				25-49	100.64	103.56	106.30	109.22	112.14	114.97	120.76	126.52	132.26	
				50-99	93.07	95.77	98.30	101.00	103.70	106.31	111.67	116.99	122.31	

Visit Our Website for More Information. We Build Custom Cables. Notes: Cable assembly max frequency may be lower than connector or coax max frequency

 Free Freight Available via UPS Ground to USA & Canada

 Real-Time Stock Levels & Pricing On Our Website

 Toll-Free Technical Support (866) 727-8376

 Same-Day Shipping, Even Custom Cable Assemblies

165 SERIES CABLE ASSEMBLIES

Product Features

- 18 GHz N & 26.5 GHz SMA
- Reinforced Coaxial Interface
- 1 Inch [2.5cm] Bend Radius
- Triple Shielded Coax Cable

Description

The 26.5 GHz Flexible Cable Assembly series offer precision N connectors that operate to 18 GHz, and an SMA connector with excellent performance to 26.5 GHz. The coax provides excellent isolation and low loss performance to 26.5 GHz. These cable assemblies are constructed using non-magnetic materials.

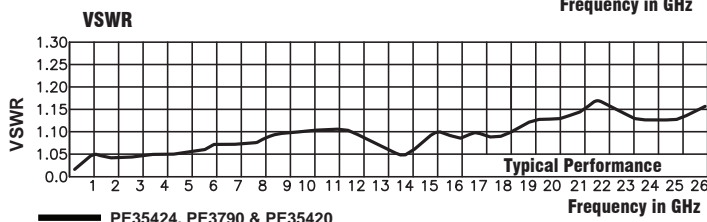
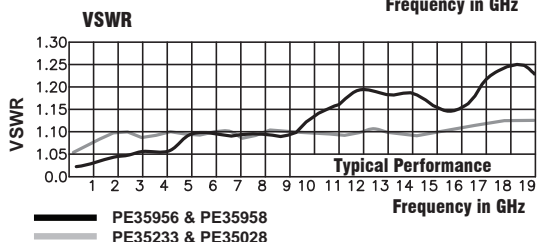
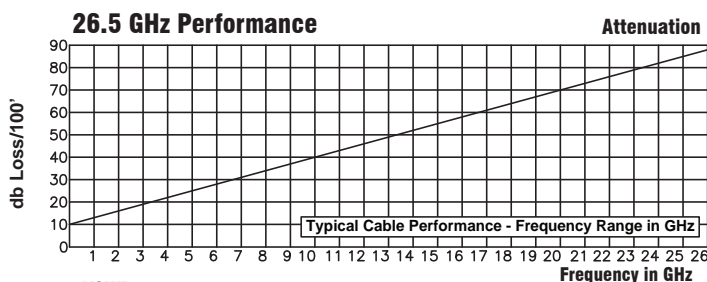
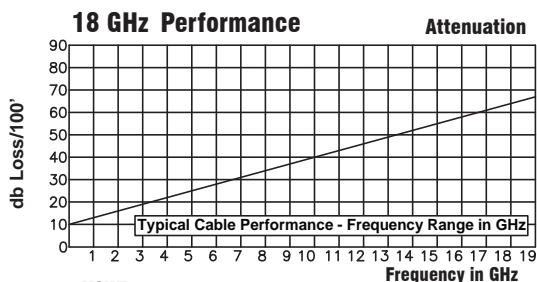

Visit Our Website for More Information. We Build Custom Cables.
Notes: Cable assembly max frequency may be lower than connector or coax max frequency

Electrical Specifications ⁽¹⁾

Parameter	Units	Value	Description
Impedance	Ohms	50Ω	
Frequency	GHz	DC to 18, 26.5	N Connector to 18 GHz, SMA to 26.5
*Maximum VSWR	GHz	DC-18, 18-26.5	DC-18 GHz, 1:15:1 / 18-26.5 GHz, 1.25:1
Cutoff Frequency	GHz	35	
Max Operating Voltage	V	1900	RMS
Nominal Capacitance	pF / ft.	29.4	
Velocity of Propagation	%	69.5	
RF Shielding	dB	>90	

*See Website for detailed VSWR Specifications for each PE Part Number.

Mechanical Specifications ⁽¹⁾





Parameter	Units	Value	Description
Minimum Bend Radius	in. [cm]	1.0 [2.5]	
Operating Temperature	C	-50° to +205°	
Inner Conductor Diameter	in. [cm]	0.036 [.09]	Silver plated Beryllium Cu
Dielectric Diameter	in. [cm]	0.116 [.29]	PTFE
Jacket Diameter	in. [cm]	0.165 [.42]	FEP

(1) Pasternack reserves the right to change specifications or information without notice.

ROHS & REACH COMPLIANT. CUSTOM-LENGTH CABLE ASSEMBLIES MAY BE ORDERED ON OUR WEBSITE.

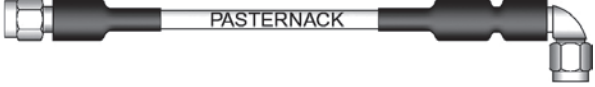
165 SERIES CABLE ASSEMBLIES

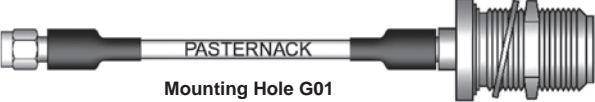
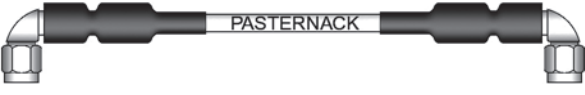
See Page 246 for Mounting Holes

	
PE3790 - SMA Male to SMA Male	PE35420 - SMA Male to SMA Male Right Angle
	
PE33233 - SMA Male to N Male	PE35958 - SMA Male to N Female Bulkhead Mounting Hole G01
	
PE35424 - SMA Male Right Angle to SMA Male Right Angle	PE35028 - N Male to N Male
	<p>For Custom Lengths or Special Configurations, Please call (949) 261-1920 or Visit www.pasternack.com</p>
PE35956 - N Male to N Female Bulkhead Mounting Hole G01	

Cable Assemblies

Visit Our Website for More Information. We Build Custom Cables.
Notes: Cable assembly max frequency may be lower than connector or coax max frequency.

Standard Length Pricing

P/N	Connector 1	Connector 2	Freq GHz	Price Breaks	Length (in.)								ROW	
					-6	-12	-18	-24	-30	-36	-48	-60		-72
PE3790	SMA Male	SMA Male	26.5	1-24	\$89.68	\$94.90	\$100.32	\$105.69	\$111.01	\$116.58	\$127.27	\$137.96	\$148.75	1
				25-49	83.40	88.26	93.30	98.29	103.24	108.42	118.36	128.30	138.34	
				50-99	77.12	81.61	86.28	90.89	95.47	100.26	109.45	118.65	127.93	
PE35420	SMA Male	SMA Male Right Angle	26.5	1-24	137.30	142.42	147.59	152.70	157.87	162.99	173.43	182.09	193.95	2
				25-49	127.69	132.45	137.26	142.01	146.82	151.58	161.29	169.34	180.37	
				50-99	118.08	122.48	126.93	131.32	135.77	140.17	149.15	156.60	166.80	
PE33233	SMA Male	N Male	18	1-24	107.21	112.53	117.95	123.37	130.51	137.66	144.75	157.26	166.13	3
				25-49	99.71	104.65	109.69	114.73	121.37	128.02	134.62	146.25	154.50	
				50-99	92.20	96.78	101.44	106.10	112.24	118.39	124.49	135.24	142.87	
PE35958	SMA Male	N Female Bulkhead	18	1-24	113.69	116.83	120.03	123.37	126.61	129.85	136.29	142.82	149.41	4
				25-49	105.73	108.65	111.63	114.73	117.75	120.76	126.75	132.82	138.95	
				50-99	97.77	100.47	103.23	106.10	108.88	111.67	117.21	122.83	128.49	
PE35424	SMA Male Right Angle	SMA Male Right Angle	26.5	1-24	172.56	177.83	182.75	188.02	193.13	198.10	208.33	218.52	228.60	5
				25-49	160.48	165.38	169.96	174.86	179.61	184.23	193.75	203.22	212.60	
				50-99	148.40	152.93	157.17	161.70	166.09	170.37	179.16	187.93	196.60	
PE35028	N Male	N Male	18	1-24	118.76	124.18	129.65	135.12	140.60	146.17	157.06	169.68	186.04	6
				25-49	110.45	115.49	120.57	125.66	130.76	135.94	146.07	157.80	173.02	
				50-99	102.13	106.79	111.50	116.20	120.92	125.71	135.07	145.92	159.99	
PE35956	N Male	N Female Bulkhead	18	1-24	135.88	139.43	143.13	146.83	150.42	154.07	161.32	168.56	175.76	7
				25-49	126.37	129.67	133.11	136.55	139.89	143.29	150.03	156.76	163.46	
				50-99	116.86	119.91	123.09	126.27	129.36	132.50	138.74	144.96	151.15	

For Custom Lengths or Special Configurations, Please call (949) 261-1920 or visit www.Pasternack.com for Pricing.

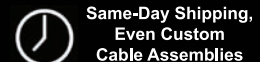

095 SERIES CABLE ASSEMBLIES

Product Features

- Operation to 65 GHz using 1.85mm connectors
- Double shielding construction for high isolation
- Flexible .095 inch [0.24cm] coaxial diameter
- A bend radius of 1 inch [2.54cm]

Description

A miniature and flexible cable with frequency of operation to 65 GHz is designed with a silver plated ribbon and braid for excellent isolation. Its flexibility is great for routing within communications hardware. The cable assemblies are offered in a combination of 2.92mm, 2.4mm and 1.85mm connectors to meet a wide variety of millimeter wave applications.

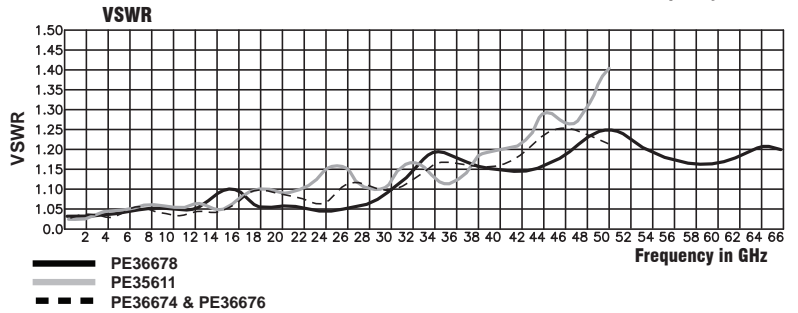
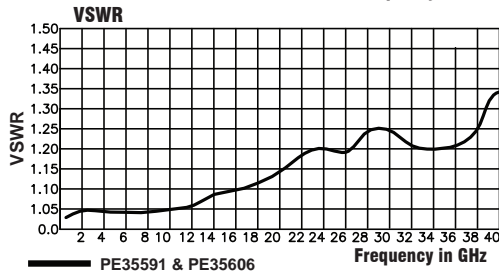
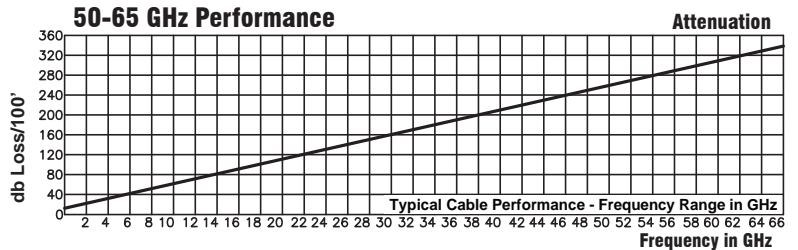
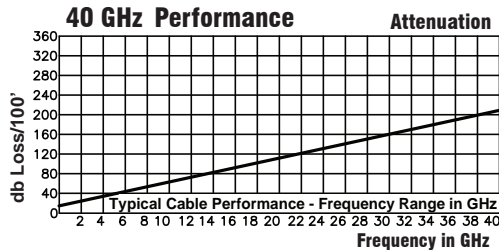

Electrical Specifications ⁽¹⁾

Parameter	Units	Value	Description
Impedance	Ohms	50Ω	
Frequency	GHz	DC to 40, 50, 65	2.92mm-40 GHz, 2.4mm-50 GHz, 1.85mm-65 GHz
*Maximum VSWR	GHz	DC-6, 6-18, 27-65	DC-6 GHz, 1:10:1 / 6-18 GHz, 1.15:1 / 27-65 GHz, 1.20:1
Cutoff Frequency	GHz	60	
Max Operating Voltage	V	1200	RMS
Nominal Capacitance	pF / ft.	29.4	
Velocity of Propagation	%	69.5	
RF Shielding	dB	>90	

*See Website for detailed VSWR Specifications for each PE Part Number.







Mechanical Specifications ⁽¹⁾

Parameter	Units	Value	Description
Minimum Bend Radius	in. [cm]	1 [2.54]	
Operating Temperature	C	-50° to +205°	
Inner Conductor Diameter	in. [cm]	0.020 [.05]	Silver plated Cu Clad Steel
Dielectric Diameter	in. [cm]	0.066 [.17]	PTFE
Jacket Diameter	in. [cm]	0.095 [.24]	FEP

(1) Pasternack reserves the right to change specifications or information without notice.

095 SERIES CABLE ASSEMBLIES

Cable Assemblies

	
PE35591 - 2.92mm Male to 2.92mm Male	PE35606 - 2.92mm Male to 2.4mm Male
	
PE36674 - 2.92mm Male to 1.85mm Male	PE35611 - 2.4mm Male to 2.4mm Male
	
PE36676 - 2.4mm Male to 1.85mm Male	PE36678 - 1.85mm Male to 1.85mm Male

**For Custom Lengths or Special Configurations,
Please call (949) 261-1920 or
Visit www.pasternack.com**

Standard Length Pricing

P/N	Connector 1	Connector 2	Freq GHz	Price Breaks	Length (in.)								ROW	
					-6	-12	-18	-24	-30	-36	-48	-60		-72
PE35591	2.92mm Male	2.92mm Male	40	1-24	\$114.50	\$118.25	\$122.20	\$123.37	\$129.75	\$133.60	\$141.20	\$145.81	\$153.16	1
				25-49	106.49	109.97	113.65	114.73	120.67	124.25	131.32	135.60	142.44	
				50-99	98.47	101.70	105.09	106.10	111.59	114.90	121.43	125.40	131.72	
PE35606	2.92mm Male	2.4mm Male	40	1-24	118.40	122.05	125.60	129.20	136.29	139.99	143.48	150.73	157.97	2
				25-49	110.11	113.51	116.81	120.16	126.75	130.19	133.44	140.18	146.91	
				50-99	101.82	104.96	108.02	111.11	117.21	120.39	123.39	129.63	135.85	
PE36674	2.92mm Male	1.85mm Male	40	1-24	124.43	127.98	131.48	135.12	138.72	142.22	149.41	156.35	163.55	3
				25-49	115.72	119.02	122.28	125.66	129.01	132.26	138.95	145.41	152.10	
				50-99	107.01	110.06	113.07	116.20	119.30	122.31	128.49	134.46	140.65	
PE35611	2.4mm Male	2.4mm Male	50	1-24	124.43	127.98	134.31	138.01	141.36	150.73	152.65	156.35	163.55	4
				25-49	115.72	119.02	124.91	128.35	131.46	140.18	141.96	145.41	152.10	
				50-99	107.01	110.06	115.51	118.69	121.57	129.63	131.28	134.46	140.65	
PE36676	2.4mm Male	1.85mm Male	50	1-24	130.46	133.91	137.50	141.00	144.45	148.09	155.19	162.23	169.12	5
				25-49	121.33	124.54	127.88	131.13	134.34	137.72	144.33	150.87	157.28	
				50-99	112.20	115.16	118.25	121.26	124.23	127.36	133.46	139.52	145.44	
PE36678	1.85mm Male	1.85mm Male	65	1-24	141.71	145.26	149.01	152.70	156.30	159.95	167.19	174.49	181.79	6
				25-49	131.79	135.09	138.58	142.01	145.36	148.75	155.49	162.28	169.06	
				50-99	121.87	124.92	128.15	131.32	134.42	137.56	143.78	150.06	156.34	

**For Custom Lengths or Special Configurations, Please call (949) 261-1920 or
visit www.Pasternack.com for Pricing.**

Visit Our Website for More Information. We Build Custom Cables.
Notes: Cable assembly max frequency may be lower than connector or coax max frequency



Real-Time Stock Levels & Pricing On Our WebSite



Toll-Free Technical Support (866) 727-8376



Same-Day Shipping, Even Custom Cable Assemblies

NEW

SMA FORMABLE PRECISION CABLE ASSEMBLIES

Pasternack's Formable Precision Cable Assemblies are 100% RF tested. These precision cable assemblies are available in 086 type and 141 type formable cable and can be ordered with or without a Black FEP Jacket material. Standard lengths from 6 to 24 inches are available for same day shipment. Custom length cables are also available upon request by contacting Pasternack Customer Service, directly, or through our website at www.pasternack.com.

Product Features

- 100% VSWR Tested to Max Frequency
- 100% Hi-Pot & Continuity Tested
- Stainless Steel coupling nut Ni/Au-plated brass body
- Anti Torque Straight SMA connectors
- Hand formable flexible semirigid
- ROHS Compliant

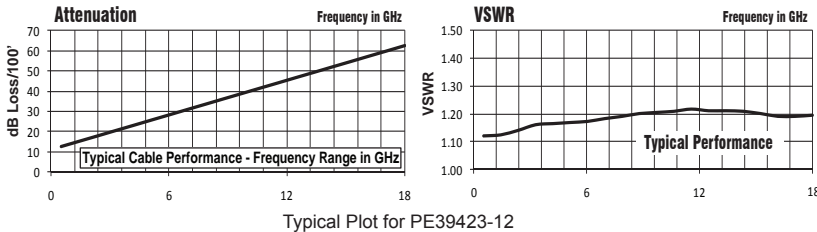

Electrical Specifications ⁽¹⁾

Parameter	Units	SMA Straight	SMA Right Angle	MCX/ MMCX
Frequency	GHz	DC to 18 GHz	DC to 10 GHz	DC to 6 GHz
Maximum VSWR		1.35:1	1.35:1	1.35:1
Impedance	Ohms	50		
Velocity of Propagation	%	69.5		
RF Shielding	dB	>100 dB		
Max Operating Voltage	Volts	335 VRMS	335 VRMS	170 VRMS

Mechanical Specifications ⁽¹⁾

Parameter	Units	086 Tin Braid	086 Jacketed	141 Tin Braid	141 Jacketed
Jacket Diameter	Inches	0.086	0.100	0.141	0.161
Outer Conductor Dia.	Inches	0.086		0.141	0.141
Dielectric Diameter	Inches	0.065		0.116	
Inner Conductor Dia.	Inches	0.020		0.036	
Min Bend Radius	Inches	0.37		0.75	
Jacket Material		Tinned Braid	Black FEP	Tinned Braid	Black FEP
Operating Temperature	Deg C	-65° to +125°			

⁽¹⁾ Pasternack reserves the right to change specifications or information without notice.

See Page 246 for Mounting Holes

SMA Male to SMA Male	SMA Male to SMA Male R/A	SMA Male R/A to SMA Male R/A
SMA Male to SMA Female	SMA Male to SMA Female Bulkhead	SMA Male R/A to SMA Female Bulkhead
		<p>For Custom Lengths or Special Configurations, Please call (949) 261-1920 or Visit www.pasternack.com</p>
SMA Female Bulkhead to MMCX Plug R/A	SMA Female Bulkhead to MCX Plug R/A	

Connector 1	Connector 2	Freq GHz	Cable Dia.	Jacketed	P/N	Price Breaks	Length (in.)					ROW
							-6	-9	-12	-18	-24	
SMA Male	SMA Male	18	.100"	X	PE39429	1-24	\$37.24	\$39.52	\$41.80	\$46.36	\$50.92	1
						25-49	34.63	36.75	38.87	43.11	47.36	
						50-99	32.03	33.99	35.95	39.87	43.79	
			.086"		PE39415	1-24	\$35.47	\$37.75	\$40.03	\$44.59	\$49.15	2
						25-49	32.99	35.11	37.23	41.47	45.71	
						50-99	30.50	32.47	34.43	38.35	42.27	
			.161"	X	PE39437	1-24	\$37.24	\$39.37	\$41.49	\$45.75	\$50.01	3
						25-49	34.63	36.61	38.59	42.55	46.51	
						50-99	32.03	33.86	35.68	39.35	43.01	
			.141"		PE39423	1-24	\$35.47	\$37.59	\$39.72	\$43.98	\$48.23	4
						25-49	32.99	34.96	36.94	40.90	44.85	
						50-99	30.50	32.33	34.16	37.82	41.48	

Cable Assemblies

Visit Our Website for More Information. We Build Custom Cables. Notes: Cable assembly max frequency may be lower than connector or coax max frequency

ROHS & REACH COMPLIANT. CUSTOM-LENGTH CABLE ASSEMBLIES MAY BE ORDERED ON OUR WEBSITE.

www.pasternack.com

Toll-Free: 866-727-8376

Phone: 949-261-1920

Fax: 949-261-7451

Connector 1	Connector 2	Freq GHz	Cable Dia.	Jacketed	P/N	Price Breaks	Length (in.)					ROW
							-6	-9	-12	-18	-24	
SMA Male	SMA Male Right Angle	10	.100"	X	PE39431	1-24	\$39.77	\$42.05	\$44.33	\$48.89	\$53.45	1
						25-49	36.99	39.11	41.23	45.47	49.71	
						50-99	34.20	36.16	38.12	42.05	45.97	
			.086"	PE39417	1-24	\$38.00	\$40.28	\$42.56	\$47.12	\$51.68	2	
					25-49	35.34	37.46	39.58	43.82	48.06		
					50-99	32.68	34.64	36.60	40.52	44.44		
		.161"	X	PE39439	1-24	\$39.77	\$41.90	\$44.03	\$48.28	\$52.54	3	
					25-49	36.99	38.97	40.95	44.90	48.86		
					50-99	34.20	36.03	37.87	41.52	45.18		
		.141"	PE39425	1-24	\$38.00	\$40.13	\$42.25	\$46.51	\$50.77	4		
				25-49	35.34	37.32	39.29	43.25	47.22			
				50-99	32.68	34.51	36.34	40.00	43.66			
SMA Male Right Angle	SMA Male Right Angle	10	.100"	X	PE39430	1-24	\$42.31	\$44.59	\$46.87	\$51.42	\$55.98	5
						25-49	39.35	41.47	43.59	47.82	52.06	
						50-99	36.39	38.35	40.31	44.22	48.14	
			.086"	PE39416	1-24	\$40.53	\$42.81	\$45.09	\$49.65	\$54.21	6	
					25-49	37.69	39.81	41.93	46.17	50.42		
					50-99	34.86	36.82	38.78	42.70	46.62		
		.161"	X	PE39438	1-24	\$42.31	\$44.43	\$46.56	\$50.82	\$55.07	7	
					25-49	39.35	41.32	43.30	47.26	51.22		
					50-99	36.39	38.21	40.04	43.71	47.36		
		.141"	PE39424	1-24	\$40.53	\$42.66	\$44.79	\$49.04	\$53.30	8		
				25-49	37.69	39.67	41.65	45.61	49.57			
				50-99	34.86	36.69	38.52	42.17	45.84			
SMA Male	SMA Female	18	.100"	X	PE39432	1-24	\$42.31	\$44.59	\$46.87	\$51.42	\$55.98	9
						25-49	39.35	41.47	43.59	47.82	52.06	
						50-99	36.39	38.35	40.31	44.22	48.14	
			.086"	PE39418	1-24	\$40.53	\$42.81	\$45.09	\$49.65	\$54.21	10	
					25-49	37.69	39.81	41.93	46.17	50.42		
					50-99	34.86	36.82	38.78	42.70	46.62		
		.161"	X	PE39440	1-24	\$42.31	\$44.43	\$46.56	\$50.82	\$55.07	11	
					25-49	39.35	41.32	43.30	47.26	51.22		
					50-99	36.39	38.21	40.04	43.71	47.36		
		.141"	PE39426	1-24	\$40.53	\$42.66	\$44.79	\$49.04	\$53.30	12		
				25-49	37.69	39.67	41.65	45.61	49.57			
				50-99	34.86	36.69	38.52	42.17	45.84			
SMA Male	SMA Female Bulkhead	18	.100"	X	PE39433	1-24	\$42.31	\$44.59	\$46.87	\$51.42	\$55.98	13
						25-49	39.35	41.47	43.59	47.82	52.06	
						50-99	36.39	38.35	40.31	44.22	48.14	
			.086"	PE39419	1-24	\$40.53	\$42.81	\$45.09	\$49.65	\$54.21	14	
					25-49	37.69	39.81	41.93	46.17	50.42		
					50-99	34.86	36.82	38.78	42.70	46.62		
		.161"	X	PE39441	1-24	\$42.31	\$44.43	\$46.56	\$50.82	\$55.07	15	
					25-49	39.35	41.32	43.30	47.26	51.22		
					50-99	36.39	38.21	40.04	43.71	47.36		
		.141"	PE39427	1-24	\$40.53	\$42.66	\$44.79	\$49.04	\$53.30	16		
				25-49	37.69	39.67	41.65	45.61	49.57			
				50-99	34.86	36.69	38.52	42.17	45.84			
SMA Male Right Angle	SMA Female Bulkhead	10	.100"	X	PE39434	1-24	\$43.32	\$45.60	\$47.88	\$52.44	\$57.00	17
						25-49	40.29	42.41	44.53	48.77	53.01	
						50-99	37.26	39.22	41.18	45.10	49.02	
			.086"	PE39420	1-24	\$41.55	\$43.83	\$46.11	\$50.67	\$55.22	18	
					25-49	38.64	40.76	42.88	47.12	51.35		
					50-99	35.73	37.69	39.65	43.58	47.49		
		.161"	X	PE39442	1-24	\$43.32	\$45.45	\$47.57	\$51.83	\$56.09	19	
					25-49	40.29	42.27	44.24	48.20	52.16		
					50-99	37.26	39.09	40.91	44.57	48.24		
		.141"	PE39428	1-24	\$41.55	\$43.67	\$45.80	\$50.06	\$54.31	20		
				25-49	38.64	40.61	42.59	46.56	50.51			
				50-99	35.73	37.56	39.39	43.05	46.71			
SMA Female Bulkhead	MMCX Plug Right Angle	6	.100"	X	PE39436	1-24	\$43.32	\$45.60	\$47.88	\$52.44	\$57.00	21
						25-49	40.29	42.41	44.53	48.77	53.01	
						50-99	37.26	39.22	41.18	45.10	49.02	
			.086"	PE39422	1-24	\$41.55	\$43.83	\$46.11	\$50.67	\$55.22	22	
					25-49	38.64	40.76	42.88	47.12	51.35		
					50-99	35.73	37.69	39.65	43.58	47.49		
SMA Female Bulkhead	MCX Plug Right Angle	6	.100"	X	PE39435	1-24	\$41.55	\$43.83	\$46.11	\$50.67	\$55.22	23
						25-49	38.64	40.76	42.88	47.12	51.35	
						50-99	35.73	37.69	39.65	43.58	47.49	
			.086"	PE39421	1-24	\$39.52	\$41.80	\$44.08	\$48.64	\$53.20	24	
					25-49	36.75	38.87	40.99	45.24	49.48		
					50-99	33.99	35.95	37.91	41.83	45.75		

NEW

N FORMABLE PRECISION CABLE ASSEMBLIES

Pasternack's Formable Precision Cable Assemblies are 100% RF tested. These precision cable assemblies are available in 086 type and 141 type formable cable and can be ordered with or without a Black FEP Jacket material. Standard lengths from 6 to 24 inches are available for same day shipment. Custom length cables are also available upon request by contacting Pasternack Customer Service, directly, or through our website at www.pasternack.com.

Product Features

- 100% VSWR Tested to Max Frequency
- 100% Hi-Pot & Continuity Tested
- Ni plated brass coupling nut and brass body
- Hand formable flexible semirigid
- ROHS Compliant

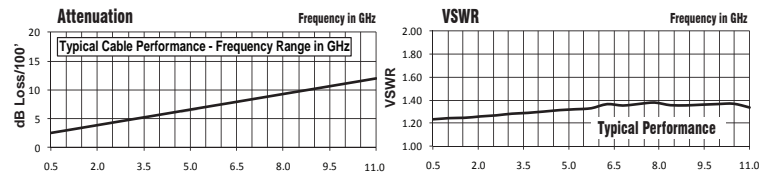

Typical Plot for PE39451-12

Electrical Specifications ⁽¹⁾

Parameter	Units	N Straight	N Right Angle	MCX/ MMCX
Frequency	GHz	DC to 11 GHz	DC to 11 GHz	DC to 6 GHz
Maximum VSWR		1.35:1 (Male) / 1.50:1 (Female)	1.50:1	1.35:1
Impedance	Ohms	50		
Velocity of Propagation	%	69.5		
RF Shielding	dB	>100 dB		
Max Operating Voltage	Volts	350 VRMS	350 VRMS	170 VRMS

Mechanical Specifications ⁽¹⁾

Parameter	Units	086 Tin Braid	086 Jacketed	141 Tin Braid	141 Jacketed
Jacket Diameter	Inches	0.086	0.100	0.141	0.161
Outer Conductor Dia.	Inches	0.086		0.141	
Dielectric Diameter	Inches	0.065		0.116	
Inner Conductor Dia.	Inches	0.020		0.036	
Min Bend Radius	Inches	0.37		0.75	
Jacket Material		Tinned Braid	Black FEP	Tinned Braid	Black FEP
Operating Temperature	Deg C	-65° to +125°			

⁽¹⁾ Pasternack reserves the right to change specifications or information without notice.

See Page 246 for Mounting Holes

N Male to N Male	N Male to N Male R/A	N Male R/A to N Male R/A
N Male to N Female	N Female Bulkhead to SMA Male	N Female Bulkhead to SMA Male R/A
		<p>For Custom Lengths or Special Configurations, Please call (949) 261-1920 or Visit www.pasternack.com</p>
N Female Bulkhead to MMCX Plug R/A	N Female Bulkhead to MCX Plug R/A	

Connector 1	Connector 2	Freq GHz	Cable Dia.	Jacketed	P/N	Price Breaks	Length (in.)					ROW	
							-6	-9	-12	-18	-24		
N Male	N Male	11	.100"	X	PE39457	1-24	\$49.40	\$51.68	\$53.96	\$58.52	\$63.08	1	
						25-49	45.94	48.06	50.18	54.42	58.66		
						50-99	42.48	44.44	46.41	50.33	54.25		
						1-24	\$47.88	\$50.16	\$52.44	\$57.00	\$61.56		2
						25-49	44.53	46.65	48.77	53.01	57.25		
						50-99	41.18	43.14	45.10	49.02	52.94		
			1-24	\$49.40	\$51.53	\$53.65	\$57.91	\$62.17	3				
			25-49	45.94	47.92	49.89	53.86	57.82					
			50-99	42.48	44.32	46.14	49.80	53.47					
			1-24	\$47.88	\$50.01	\$52.13	\$56.39	\$60.65		4			
			25-49	44.53	46.51	48.48	52.44	56.40					
			50-99	41.18	43.01	44.83	48.50	52.16					

ROHS & REACH COMPLIANT. CUSTOM-LENGTH CABLE ASSEMBLIES MAY BE ORDERED ON OUR WEBSITE.

www.pasternack.com

Toll-Free: 866-727-8376

Phone: 949-261-1920

Fax: 949-261-7451

Connector 1	Connector 2	Freq GHz	Cable Dia.	Jacketed	P/N	Price Breaks	Length (in.)					ROW
							-6	-9	-12	-18	-24	
N Male	N Male Right Angle	11	.100"	X	PE39459	1-24	\$54.46	\$56.74	\$59.02	\$63.58	\$68.14	1
						25-49	50.65	52.77	54.89	59.13	63.37	
						50-99	46.84	48.80	50.76	54.68	58.60	
			.086"		PE39445	1-24	\$52.94	\$55.22	\$57.50	\$62.06	\$66.62	2
						25-49	49.23	51.35	53.48	57.72	61.96	
						50-99	45.53	47.49	49.45	53.37	57.29	
			.161"	X	PE39467	1-24	\$54.46	\$56.59	\$58.72	\$62.98	\$67.23	3
						25-49	50.65	52.63	54.61	58.57	62.52	
						50-99	46.84	48.67	50.50	54.16	57.82	
			.141"		PE39453	1-24	\$52.94	\$55.07	\$57.20	\$61.46	\$65.71	4
						25-49	49.23	51.22	53.20	57.16	61.11	
						50-99	45.53	47.36	49.19	52.86	56.51	
N Male Right Angle	N Male Right Angle	11	.100"	X	PE39458	1-24	\$60.04	\$62.32	\$64.60	\$69.16	\$73.72	5
						25-49	55.84	57.96	60.08	64.32	68.56	
						50-99	51.63	53.60	55.56	59.48	63.40	
			.086"		PE39444	1-24	\$58.26	\$60.54	\$62.82	\$67.38	\$71.94	6
						25-49	54.18	56.30	58.42	62.66	66.90	
						50-99	50.10	52.06	54.03	57.95	61.87	
			.161"	X	PE39466	1-24	\$60.04	\$62.17	\$64.29	\$68.55	\$72.81	7
						25-49	55.84	57.82	59.79	63.75	67.71	
						50-99	51.63	53.47	55.29	58.95	62.62	
			.141"		PE39452	1-24	\$58.26	\$60.39	\$62.52	\$66.78	\$71.03	8
						25-49	54.18	56.16	58.14	62.11	66.06	
						50-99	50.10	51.94	53.77	57.43	61.09	
N Male	N Female	11	.100"	X	PE39460	1-24	\$50.16	\$52.44	\$54.72	\$59.28	\$63.84	9
						25-49	46.65	48.77	50.89	55.13	59.37	
						50-99	43.14	45.10	47.06	50.98	54.90	
			.086"		PE39446	1-24	\$48.64	\$50.92	\$53.20	\$57.76	\$62.32	10
						25-49	45.24	47.36	49.48	53.72	57.96	
						50-99	41.83	43.79	45.75	49.67	53.60	
			.161"	X	PE39468	1-24	\$50.16	\$52.29	\$54.41	\$58.67	\$62.93	11
						25-49	46.65	48.63	50.60	54.56	58.52	
						50-99	43.14	44.97	46.79	50.46	54.12	
			.141"		PE39454	1-24	\$48.64	\$50.77	\$52.89	\$57.15	\$61.41	12
						25-49	45.24	47.22	49.19	53.15	57.11	
						50-99	41.83	43.66	45.49	49.15	52.81	
N Female Bulkhead	SMA Male	11	.100"	X	PE39461	1-24	\$54.46	\$56.74	\$59.02	\$63.58	\$68.14	13
						25-49	50.65	52.77	54.89	59.13	63.37	
						50-99	46.84	48.80	50.76	54.68	58.60	
			.086"		PE39447	1-24	\$52.94	\$55.22	\$57.50	\$62.06	\$66.62	14
						25-49	49.23	51.35	53.48	57.72	61.96	
						50-99	45.53	47.49	49.45	53.37	57.29	
			.161"	X	PE39469	1-24	\$54.46	\$56.59	\$58.72	\$62.98	\$67.23	15
						25-49	50.65	52.63	54.61	58.57	62.52	
						50-99	46.84	48.67	50.50	54.16	57.82	
			.141"		PE39455	1-24	\$52.94	\$55.07	\$57.20	\$61.46	\$65.71	16
						25-49	49.23	51.22	53.20	57.16	61.11	
						50-99	45.53	47.36	49.19	52.86	56.51	
N Female Bulkhead	SMA Male Right Angle	10	.100"	X	PE39462	1-24	\$49.40	\$51.68	\$53.96	\$58.52	\$63.08	17
						25-49	45.94	48.06	50.18	54.42	58.66	
						50-99	42.48	44.44	46.41	50.33	54.25	
			.086"		PE39448	1-24	\$47.88	\$50.16	\$52.44	\$57.00	\$61.56	18
						25-49	44.53	46.65	48.77	53.01	57.25	
						50-99	41.18	43.14	45.10	49.02	52.94	
			.161"	X	PE39470	1-24	\$49.40	\$51.53	\$53.65	\$57.91	\$62.17	19
						25-49	45.94	47.92	49.89	53.86	57.82	
						50-99	42.48	44.32	46.14	49.80	53.47	
			.141"		PE39456	1-24	\$47.88	\$50.01	\$52.13	\$56.39	\$60.65	20
						25-49	44.53	46.51	48.48	52.44	56.40	
						50-99	41.18	43.01	44.83	48.50	52.16	
N Female Bulkhead	MMCX Plug Right Angle	6	.100"	X	PE39464	1-24	\$49.40	\$51.68	\$53.96	\$58.52	\$63.08	21
						25-49	45.94	48.06	50.18	54.42	58.66	
						50-99	42.48	44.44	46.41	50.33	54.25	
			.086"		PE39450	1-24	\$47.88	\$50.16	\$52.44	\$57.00	\$61.56	22
						25-49	44.53	46.65	48.77	53.01	57.25	
						50-99	41.18	43.14	45.10	49.02	52.94	
N Female Bulkhead	MCX Plug Right Angle	6	.100"	X	PE39463	1-24	\$47.88	\$50.16	\$52.44	\$57.00	\$61.56	23
						25-49	44.53	46.65	48.77	53.01	57.25	
						50-99	41.18	43.14	45.10	49.02	52.94	
			.086"		PE39449	1-24	\$46.11	\$48.39	\$50.67	\$55.22	\$59.78	24
						25-49	42.88	45.00	47.12	51.35	55.60	
						50-99	39.65	41.62	43.58	47.49	51.41	

NEW TNC FORMABLE PRECISION CABLE ASSEMBLIES

Pasternack's Formable Precision Cable Assemblies are 100% RF tested. These precision cable assemblies are available in 086 type and 141 type formable cable and can be ordered with or without a Black FEP Jacket material. Standard lengths from 6 to 24 inches are available for same day shipment. Custom length cables are also available upon request by contacting Pasternack Customer Service, directly, or through our website at www.pasternack.com.

Product Features

- 100% VSWR Tested to Max Frequency
- 100% Hi-Pot & Continuity Tested
- Ni plated brass coupling nut and brass body
- Hand formable flexible semirigid
- ROHS Compliant

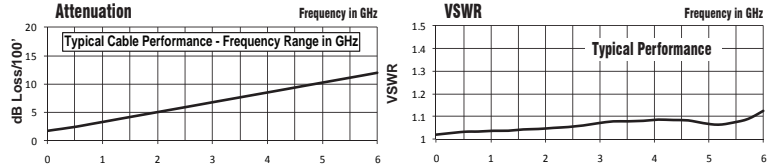

Typical Plot for PE39479-12

Electrical Specifications ⁽¹⁾

Parameter	Units	TNC Straight	TNC Right Angle	MCX/ MMCX
Frequency	GHz	DC to 6 GHz	DC to 6 GHz	DC to 6 GHz
Maximum VSWR		1.35:1	1.50:1	1.35:1
Impedance	Ohms	50		
Velocity of Propagation	%	69.5		
RF Shielding	dB	>100 dB		
Max Operating Voltage	Volts	500 VRMS	500 VRMS	170 VRMS

Mechanical Specifications ⁽¹⁾

Parameter	Units	086 Tin Braid	086 Jacketed	141 Tin Braid	141 Jacketed
Jacket Diameter	Inches	0.086	0.100	0.141	0.161
Outer Conductor Dia.	Inches	0.086		0.141	
Dielectric Diameter	Inches	0.065		0.116	
Inner Conductor Dia.	Inches	0.020		0.036	
Min Bend Radius	Inches	0.37		0.75	
Jacket Material		Tinned Braid	Black FEP	Tinned Braid	Black FEP
Operating Temperature	Deg C	-65° to +125°			

(1) Pasternack reserves the right to change specifications or information without notice.

See Page 246 for Mounting Holes

TNC Male to TNC Male	TNC Male to TNC Male R/A	TNC Male R/A to TNC Male R/A
TNC Male to TNC Female	TNC Female Bulkhead to SMA Male	TNC Female Bulkhead to SMA Male R/A
		<p>For Custom Lengths or Special Configurations, Please call (949) 261-1920 or Visit www.pasternack.com</p>
TNC Female Bulkhead to MMCX Plug R/A	TNC Female Bulkhead to MCX Plug R/A	

Connector 1	Connector 2	Freq GHz	Cable Dia.	Jacketed	P/N	Price Breaks	Length (in.)					ROW	
							-6	-9	-12	-18	-24		
TNC Male	TNC Male	6	.100"	X	PE39485	1-24	\$40.79	\$43.07	\$45.35	\$49.91	\$54.46	1	
						25-49	37.93	40.06	42.18	46.42	50.65		
						50-99	35.08	37.04	39.00	42.92	46.84		
						1-24	\$39.27	\$41.55	\$43.83	\$48.39	\$52.94		2
						25-49	36.52	38.64	40.76	45.00	49.23		
						50-99	33.77	35.73	37.69	41.62	45.53		
			1-24	\$40.79	\$42.91	\$45.04	\$49.30	\$53.55	3				
			25-49	37.93	39.91	41.89	45.85	49.80					
			50-99	35.08	36.90	38.73	42.40	46.05					
			1-24	\$39.27	\$41.39	\$43.52	\$47.78	\$52.03		4			
			25-49	36.52	38.49	40.47	44.44	48.39					
			50-99	33.77	35.60	37.43	41.09	44.75					

Connector 1	Connector 2	Freq GHz	Cable Dia.	Jacketed	P/N	Price Breaks	Length (in.)					ROW
							-6	-9	-12	-18	-24	
TNC Male	TNC Male Right Angle	6	.100"	X	PE39487	1-24	\$43.32	\$45.60	\$47.88	\$52.44	\$57.00	1
						25-49	40.29	42.41	44.53	48.77	53.01	2
						50-99	37.26	39.22	41.18	45.10	49.02	3
			.086"		PE39473	1-24	\$41.80	\$44.08	\$46.36	\$50.92	\$55.48	4
						25-49	38.87	40.99	43.11	47.36	51.60	5
						50-99	35.95	37.91	39.87	43.79	47.71	6
			.161"	X	PE39495	1-24	\$43.32	\$45.45	\$47.57	\$51.83	\$56.09	7
						25-49	40.29	42.27	44.24	48.20	52.16	8
						50-99	37.26	39.09	40.91	44.57	48.24	9
			.141"		PE39481	1-24	\$41.80	\$43.93	\$46.05	\$50.31	\$54.57	10
						25-49	38.87	40.85	42.83	46.79	50.75	11
						50-99	35.95	37.78	39.60	43.27	46.93	12
TNC Male Right Angle	TNC Male Right Angle	6	.100"	X	PE39486	1-24	\$45.85	\$48.13	\$50.41	\$54.97	\$59.53	13
						25-49	42.64	44.76	46.88	51.12	55.36	14
						50-99	39.43	41.39	43.35	47.27	51.20	15
			.086"		PE39472	1-24	\$44.33	\$46.61	\$48.89	\$53.45	\$58.01	16
						25-49	41.23	43.35	45.47	49.71	53.95	17
						50-99	38.12	40.08	42.05	45.97	49.89	18
			.161"	X	PE39494	1-24	\$45.85	\$47.98	\$50.11	\$54.36	\$58.62	19
						25-49	42.64	44.62	46.60	50.55	54.52	20
						50-99	39.43	41.26	43.09	46.75	50.41	21
			.141"		PE39480	1-24	\$44.33	\$46.46	\$48.59	\$52.84	\$57.10	22
						25-49	41.23	43.21	45.19	49.14	53.10	23
						50-99	38.12	39.96	41.79	45.44	49.11	24
TNC Male	TNC Female	6	.100"	X	PE39488	1-24	\$40.79	\$43.07	\$45.35	\$49.91	\$54.46	25
						25-49	37.93	40.06	42.18	46.42	50.65	26
						50-99	35.08	37.04	39.00	42.92	46.84	27
			.086"		PE39474	1-24	\$39.27	\$41.55	\$43.83	\$48.39	\$52.94	28
						25-49	36.52	38.64	40.76	45.00	49.23	29
						50-99	33.77	35.73	37.69	41.62	45.53	30
			.161"	X	PE39496	1-24	\$40.79	\$42.91	\$45.04	\$49.30	\$53.55	31
						25-49	37.93	39.91	41.89	45.85	49.80	32
						50-99	35.08	36.90	38.73	42.40	46.05	33
			.141"		PE39482	1-24	\$39.27	\$41.39	\$43.52	\$47.78	\$52.03	34
						25-49	36.52	38.49	40.47	44.44	48.39	35
						50-99	33.77	35.60	37.43	41.09	44.75	36
TNC Female Bulkhead	SMA Male	6	.100"	X	PE39489	1-24	\$47.88	\$50.16	\$52.44	\$57.00	\$61.56	37
						25-49	44.53	46.65	48.77	53.01	57.25	38
						50-99	41.18	43.14	45.10	49.02	52.94	39
			.086"		PE39475	1-24	\$46.11	\$48.39	\$50.67	\$55.22	\$59.78	40
						25-49	42.88	45.00	47.12	51.35	55.60	41
						50-99	39.65	41.62	43.58	47.49	51.41	42
			.161"	X	PE39497	1-24	\$47.88	\$50.01	\$52.13	\$56.39	\$60.65	43
						25-49	44.53	46.51	48.48	52.44	56.40	44
						50-99	41.18	43.01	44.83	48.50	52.16	45
			.141"		PE39483	1-24	\$46.11	\$48.23	\$50.36	\$54.62	\$58.87	46
						25-49	42.88	44.85	46.83	50.80	54.75	47
						50-99	39.65	41.48	43.31	46.97	50.63	48
TNC Female Bulkhead	SMA Male Right Angle	6	.100"	X	PE39490	1-24	\$46.87	\$49.15	\$51.42	\$55.98	\$60.54	49
						25-49	43.59	45.71	47.82	52.06	56.30	50
						50-99	40.31	42.27	44.22	48.14	52.06	51
			.086"		PE39476	1-24	\$45.09	\$47.37	\$49.65	\$54.21	\$58.77	52
						25-49	41.93	44.05	46.17	50.42	54.66	53
						50-99	38.78	40.74	42.70	46.62	50.54	54
			.161"	X	PE39498	1-24	\$46.87	\$48.99	\$51.12	\$55.38	\$59.63	55
						25-49	43.59	45.56	47.54	51.50	55.46	56
						50-99	40.31	42.13	43.96	47.63	51.28	57
			.141"		PE39484	1-24	\$45.09	\$47.22	\$49.35	\$53.60	\$57.86	58
						25-49	41.93	43.91	45.90	49.85	53.81	59
						50-99	38.78	40.61	42.44	46.10	49.76	60
TNC Female Bulkhead	MMCX Plug Right Angle	6	.100"	X	PE39492	1-24	\$46.87	\$49.15	\$51.42	\$55.98	\$60.54	61
						25-49	43.59	45.71	47.82	52.06	56.30	62
						50-99	40.31	42.27	44.22	48.14	52.06	63
			.086"		PE39478	1-24	\$45.09	\$47.37	\$49.65	\$54.21	\$58.77	64
						25-49	41.93	44.05	46.17	50.42	54.66	65
						50-99	38.78	40.74	42.70	46.62	50.54	66
TNC Female Bulkhead	MCX Plug Right Angle	6	.100"	X	PE39491	1-24	\$45.09	\$47.37	\$49.65	\$54.21	\$58.77	67
						25-49	41.93	44.05	46.17	50.42	54.66	68
						50-99	38.78	40.74	42.70	46.62	50.54	69
			.086"		PE39477	1-24	\$43.57	\$45.85	\$48.13	\$52.69	\$57.25	70
						25-49	40.52	42.64	44.76	49.00	53.24	71
						50-99	37.47	39.43	41.39	45.31	49.24	72

Cable Assemblies

*Coax Performance at 1 GHz
Notes: Cable assembly max frequency may be lower than connector or coax max frequency

SMA MALE TO SMA MALE									
									
Cable Dia.	Atten.*	Max Power*	Length	Model No.	1-24	25-49	50-99		
Precision Flexible Cable Assemblies									
Please see precision section, page 6-29									
50 Ohm, 150 Series Coax				PE34286					1
50 Ohm, 165 Non-Magnetic Series Coax				PE3790					2
50 Ohm, 300 Series Coax				PE300					3
Precision Formable Cable Assemblies									
Please see precision section, page 6-29									
50 Ohm, PE-SR402FL Coax				PE39423					4
50 Ohm, PE-SR402FLJ Jacketed Coax				PE39437					5
50 Ohm, PE-SR405FL Coax				PE39415					6
50 Ohm, PE-SR405FLJ Jacketed Coax				PE39429					7
Standard Flexible Cable Assemblies									
See website for the following cable(s)									
50 Ohm, RG8X Coax				PE39087					8
53.5 Ohm, RG55B/U Coax				PE3572					9
50 Ohm, RG58C/U Coax									
0.195" dia.	20 dB / 100 ft.	44 W	12"	PE3369-12	\$37.15	\$34.55	\$31.95		10
			24"	PE3369-24	\$37.50	\$34.88	\$32.25		
			36"	PE3369-36	\$37.90	\$35.25	\$32.59		
			48"	PE3369-48	\$38.35	\$35.67	\$32.98		
			60"	PE3369-60	\$38.85	\$36.13	\$33.41		
			Any	PE3369-XX	See Website for Pricing				
See website for the following cable(s)									
93 Ohm, RG62A/U Coax				PE3899					11
50 Ohm, RG142B/U Coax									
0.195" dia.	13 dB / 100 ft.	650 W	12"	PE3385-12	\$41.00	\$38.13	\$35.26		12
			24"	PE3385-24	\$43.70	\$40.64	\$37.58		
			36"	PE3385-36	\$46.45	\$43.20	\$39.95		
			48"	PE3385-48	\$49.15	\$45.71	\$42.27		
			60"	PE3385-60	\$51.90	\$48.27	\$44.63		
Any	PE3385-XX	See Website for Pricing							
50 Ohm, RG174A/U Coax									
0.100" dia.	31 dB / 100 ft.	16 W	12"	PE3353-12	\$38.15	\$35.48	\$32.81		13
			24"	PE3353-24	\$38.60	\$35.90	\$33.20		
			36"	PE3353-36	\$39.05	\$36.32	\$33.58		
			48"	PE3353-48	\$39.45	\$36.69	\$33.93		
			60"	PE3353-60	\$39.90	\$37.11	\$34.31		
Any	PE3353-XX	See Website for Pricing							
50 Ohm, RG178B/U Coax									
0.750" dia.	45 dB / 100 ft.	78 W	12"	PE3574-12	\$52.40	\$48.73	\$45.06		14
			24"	PE3574-24	\$53.35	\$49.62	\$45.88		
			36"	PE3574-36	\$54.40	\$50.59	\$46.78		
			48"	PE3574-48	\$55.40	\$51.52	\$47.64		
			60"	PE3574-60	\$56.30	\$52.36	\$48.42		
Any	PE3574-XX	See Website for Pricing							
See website for the following cable(s)									
95 Ohm, RG180B/U Twinax				PE3245					15
50 Ohm, RG188A/U Coax									
0.110" dia.	30 dB / 100 ft.	160 W	12"	PE3361-12	\$39.45	\$36.69	\$33.93		16
			24"	PE3361-24	\$41.15	\$38.27	\$35.39		
			36"	PE3361-36	\$42.80	\$39.80	\$36.81		
			48"	PE3361-48	\$44.50	\$41.39	\$38.27		
			60"	PE3361-60	\$46.20	\$42.97	\$39.73		
Any	PE3361-XX	See Website for Pricing							
See website for the following cable(s)									
50 Ohm, RG188-DS Coax				PE3778					17

SMA MALE TO SMA MALE									
									
Cable Dia.	Atten.*	Max Power*	Length	Model No.	1-24	25-49	50-99		
50 Ohm, RG214/U Coax									
0.425" dia.	9 dB / 100 ft.	190 W	12"	PE3121-12	\$146.15	\$135.92	\$125.69		18
			24"	PE3121-24	\$151.90	\$141.27	\$130.63		
			36"	PE3121-36	\$157.65	\$146.61	\$135.58		
			48"	PE3121-48	\$163.40	\$151.96	\$140.52		
			60"	PE3121-60	\$169.15	\$157.31	\$145.47		
			Any	PE3121-XX	See Website for Pricing				
50 Ohm, RG223/U Coax									
0.216" dia.	16.5 dB / 100 ft.	53 W	12"	PE3377-12	\$37.55	\$34.92	\$32.29		19
			24"	PE3377-24	\$38.95	\$36.22	\$33.50		
			36"	PE3377-36	\$40.25	\$37.43	\$34.62		
			48"	PE3377-48	\$41.60	\$38.69	\$35.78		
			60"	PE3377-60	\$43.00	\$39.99	\$36.98		
			Any	PE3377-XX	See Website for Pricing				
50 Ohm, RG316/U Coax									
0.102" dia.	30 dB / 100 ft.	160 W	12"	PE3573-12	\$40.15	\$37.34	\$34.53		20
			24"	PE3573-24	\$42.50	\$39.53	\$36.55		
			36"	PE3573-36	\$44.90	\$41.76	\$38.61		
			48"	PE3573-48	\$47.30	\$43.99	\$40.68		
			60"	PE3573-60	\$49.70	\$46.22	\$42.74		
			Any	PE3573-XX	See Website for Pricing				
50 Ohm, RG316-DS Coax									
0.114" dia.	30 dB / 100 ft.	160 W	12"	PE3704-12	\$38.50	\$35.81	\$33.11		21
			24"	PE3704-24	\$40.75	\$37.90	\$35.05		
			36"	PE3704-36	\$43.05	\$40.04	\$37.02		
			48"	PE3704-48	\$45.30	\$42.13	\$38.96		
			60"	PE3704-60	\$47.60	\$44.27	\$40.94		
Any	PE3704-XX	See Website for Pricing							
50 Ohm, RG400/U Coax									
0.195" dia.	13 dB / 100 ft.	650 W	12"	PE3500-12	\$41.00	\$38.13	\$35.26		22
			24"	PE3500-24	\$43.85	\$40.78	\$37.71		
			36"	PE3500-36	\$49.25	\$45.80	\$42.36		
			48"	PE3500-48	\$54.70	\$50.87	\$47.04		
			60"	PE3500-60	\$60.15	\$55.94	\$51.73		
Any	PE3500-XX	See Website for Pricing							
See website for the following cable(s)									
50 Ohm, PE-C100 Coax				PE37908					23
50 Ohm, PE-C195 Coax									
0.195" dia.	11.5 dB / 100 ft.	150 W	12"	PE35784-12	\$27.55	\$25.62	\$23.69		24
			24"	PE35784-24	\$28.65	\$26.64	\$24.64		
			36"	PE35784-36	\$29.75	\$27.67	\$25.59		
			48"	PE35784-48	\$30.85	\$28.69	\$26.53		
			60"	PE35784-60	\$32.00	\$29.76	\$27.52		
Any	PE35784-XX	See Website for Pricing							
50 Ohm, PE-C240 Coax									
0.240" dia.	8 dB / 100 ft.	250 W	12"	PE38628-12	\$40.85	\$37.99	\$35.13		25
			24"	PE38628-24	\$43.20	\$40.18	\$37.15		
			36"	PE38628-36	\$45.55	\$42.36	\$39.17		
			48"	PE38628-48	\$47.85	\$44.50	\$41.15		
			60"	PE38628-60	\$50.20	\$46.69	\$43.17		
Any	PE38628-XX	See Website for Pricing							
See website for the following cable(s)									
75 Ohm, RG59B/U Coax				PE3814					26
75 Ohm, RG179B/U Coax									
0.100" dia.	25 dB / 100 ft.	200 W	12"	PE3739-12	\$39.65	\$36.87	\$34.10		27
			24"	PE3739-24	\$41.50	\$38.60	\$35.69		
			36"	PE3739-36	\$43.40	\$40.36	\$37.32		
			48"	PE3739-48	\$45.25	\$42.08	\$38.92		
			60"	PE3739-60	\$47.15	\$43.85	\$40.55		
Any	PE3739-XX	See Website for Pricing							

Continued on Next Page

Continued from Previous Page

SMA MALE TO SMA MALE							
							
Cable Dia.	Atten.*	Max Power*	Length	Model No.	1-24	25-49	50-99
50 Ohm, PE-P195 Coax							
0.195" dia.	12.5 dB / 100 ft.	650 W	12"	PE3138-12	\$56.50	\$52.55	\$48.59
			24"	PE3138-24	\$60.20	\$55.99	\$51.77
			36"	PE3138-36	\$63.85	\$59.38	\$54.91
			48"	PE3138-48	\$67.65	\$62.91	\$58.18
			60"	PE3138-60	\$71.40	\$66.40	\$61.40
			Any	PE3138-XX	See Website for Pricing		
Standard Formable Cable Assemblies							
See website for the following cable(s)							
50 Ohm, PE-SR047FL Coax				PE34186			
50 Ohm, PE-SR401FL Coax							
0.250" dia.	7 dB / 100 ft.	1400 W	12"	PE34188-12	\$121.20	\$112.72	\$104.23
			24"	PE34188-24	\$128.60	\$119.60	\$110.60
			36"	PE34188-36	\$136.00	\$126.48	\$116.96
			48"	PE34188-48	\$143.60	\$133.55	\$123.50
			60"	PE34188-60	\$151.85	\$141.22	\$130.59
			Any	PE34188-XX	See Website for Pricing		
50 Ohm, PE-SR402FL Coax							
0.141" dia.	12 dB / 100 ft.	450 W	12"	PE3481-12	\$38.60	\$35.90	\$33.20
			24"	PE3481-24	\$44.55	\$41.43	\$38.31
			36"	PE3481-36	\$50.50	\$46.97	\$43.43
			48"	PE3481-48	\$56.45	\$52.50	\$48.55
			60"	PE3481-60	\$62.45	\$58.08	\$53.71
			Any	PE3481-XX	See Website for Pricing		
50 Ohm, PE-SR405FL Coax							
0.085" dia.	22 dB / 100 ft.	130 W	12"	PE3867-12	\$39.30	\$36.55	\$33.80
			24"	PE3867-24	\$47.50	\$44.18	\$40.85
			36"	PE3867-36	\$55.75	\$51.85	\$47.95
			48"	PE3867-48	\$61.35	\$57.06	\$52.76
			60"	PE3867-60	\$66.55	\$61.89	\$57.23
			Any	PE3867-XX	See Website for Pricing		
Standard Semirigid Cable Assemblies							
See website for the following cable(s)							
50 Ohm, PE-020SR Coax				PE34191			
50 Ohm, PE-034SR Coax				PE34193			
50 Ohm, PE-047SR Coax							
0.047" dia.	40 dB / 100 ft.	32 W	12"	PE3656-12	\$65.90	\$61.29	\$56.67
			24"	PE3656-24	\$72.00	\$66.96	\$61.92
			36"	PE3656-36	\$77.50	\$72.08	\$66.65
			48"	PE3656-48	\$82.60	\$76.82	\$71.04
			60"	PE3656-60	\$88.30	\$82.12	\$75.94
			Any	PE3656-XX	See Website for Pricing		
See website for the following cable(s)							
50 Ohm, PE-SR047AL Coax				PE3387			
50 Ohm, PE-SR401AL Coax				PE34184			
50 Ohm, PE-SR402AL Coax							
0.141" dia.	13 dB / 100 ft.	450 W	12"	PE34180-12	\$39.85	\$37.06	\$34.27
			24"	PE34180-24	\$46.95	\$43.66	\$40.38
			36"	PE34180-36	\$52.30	\$48.64	\$44.98
			48"	PE34180-48	\$57.45	\$53.43	\$49.41
			60"	PE34180-60	\$62.80	\$58.40	\$54.01
			Any	PE34180-XX	See Website for Pricing		
50 Ohm, PE-SR405AL Coax							
0.085" dia.	23 dB / 100 ft.	130 W	12"	PE34182-12	\$37.70	\$35.06	\$32.42
			24"	PE34182-24	\$44.35	\$41.25	\$38.14
			36"	PE34182-36	\$50.95	\$47.38	\$43.82
			48"	PE34182-48	\$57.60	\$53.57	\$49.54
			60"	PE34182-60	\$64.25	\$59.75	\$55.26
			Any	PE34182-XX	See Website for Pricing		
See website for the following cable(s)							
50 Ohm, RG401/U Coax				PE33003			

SMA MALE TO SMA MALE							
							
Cable Dia.	Atten.*	Max Power*	Length	Model No.	1-24	25-49	50-99
50 Ohm, RG402/U Coax							
0.141" dia.	13 dB / 100 ft.	650 W	12"	PE3492-12	\$37.70	\$35.06	\$32.42
			24"	PE3492-24	\$42.85	\$39.85	\$36.85
			36"	PE3492-36	\$48.30	\$44.92	\$41.54
			48"	PE3492-48	\$53.55	\$49.80	\$46.05
			60"	PE3492-60	\$58.80	\$54.68	\$50.57
			Any	PE3492-XX	See Website for Pricing		
50 Ohm, RG405/U Coax							
0.085" dia.	22 dB / 100 ft.	130 W	12"	PE3818-12	\$36.35	\$33.81	\$31.26
			24"	PE3818-24	\$41.60	\$38.69	\$35.78
			36"	PE3818-36	\$46.90	\$43.62	\$40.33
			48"	PE3818-48	\$52.15	\$48.50	\$44.85
			60"	PE3818-60	\$57.45	\$53.43	\$49.41
			Any	PE3818-XX	See Website for Pricing		

SMA MALE TO SMA MALE PUSH-ON							
							
Cable Dia.	Atten.*	Max Power*	Length	Model No.	1-24	25-49	50-99
50 Ohm, 300 Series Coax							
				PE311			

SMA MALE TO SMA MALE QD							
							
Cable Dia.	Atten.*	Max Power*	Length	Model No.	1-24	25-49	50-99
50 Ohm, 300 Series Coax							
				PE312			

SMA MALE TO SMA MALE RIGHT ANGLE							
							
Cable Dia.	Atten.*	Max Power*	Length	Model No.	1-24	25-49	50-99
50 Ohm, 150 Series Coax							
				PE35418			
50 Ohm, 165 Non-Magnetic Series Coax							
				PE35420			
50 Ohm, 300 Series Coax							
				PE301			
50 Ohm, PE-SR402FL Coax							
				PE39425			
50 Ohm, PE-SR402FLJ Jacketed Coax							
				PE39439			
50 Ohm, PE-SR405FL Coax							
				PE39417			
50 Ohm, PE-SR405FLJ Jacketed Coax							
				PE39431			
50 Ohm, RG58C/U Coax							
0.195" dia.	20 dB / 100 ft.	44 W	12"	PE3319-12	\$43.95	\$40.87	\$37.80
			24"	PE3319-24	\$44.40	\$41.29	\$38.18
			36"	PE3319-36	\$44.75	\$41.62	\$38.49
			48"	PE3319-48	\$45.15	\$41.99	\$38.83
			60"	PE3319-60	\$45.60	\$42.41	\$39.22
			Any	PE3319-XX	See Website for Pricing		

Cable Assemblies

*Coax Performance at 1 GHz
Notes: Cable assembly max frequency may be lower than connector or coax max frequency

Continued on Next Page

Continued from Previous Page

SMA MALE TO SMA MALE RIGHT ANGLE



Cable Dia.	Atten.*	Max Power*	Length	Model No.	1-24	25-49	50-99
50 Ohm, RG142B/U Coax							
0.195" dia.	13 dB / 100 ft.	650 W	12"	PE3512-12	\$47.75	\$44.41	\$41.07
			24"	PE3512-24	\$50.50	\$46.97	\$43.43
			36"	PE3512-36	\$53.25	\$49.52	\$45.80
			48"	PE3512-48	\$56.00	\$52.08	\$48.16
			60"	PE3512-60	\$58.70	\$54.59	\$50.48
			Any	PE3512-XX	See Website for Pricing		
50 Ohm, RG174A/U Coax							
0.100" dia.	31 dB / 100 ft.	16 W	12"	PE3420-12	\$45.00	\$41.85	\$38.70
			24"	PE3420-24	\$45.45	\$42.27	\$39.09
			36"	PE3420-36	\$45.85	\$42.64	\$39.43
			48"	PE3420-48	\$46.30	\$43.06	\$39.82
			60"	PE3420-60	\$46.75	\$43.48	\$40.21
			Any	PE3420-XX	See Website for Pricing		
See website for the following cable(s)							
50 Ohm, RG178B/U Coax				PE3865			
95 Ohm, RG180B/U Twinax				PE3352			
50 Ohm, RG188A/U Coax							
0.110" dia.	30 dB / 100 ft.	160 W	12"	PE3510-12	\$46.25	\$43.01	\$39.78
			24"	PE3510-24	\$47.95	\$44.59	\$41.24
			36"	PE3510-36	\$49.65	\$46.17	\$42.70
			48"	PE3510-48	\$51.35	\$47.76	\$44.16
			60"	PE3510-60	\$53.05	\$49.34	\$45.62
			Any	PE3510-XX	See Website for Pricing		
See website for the following cable(s)							
50 Ohm, RG188-DS Coax				PE3779			
50 Ohm, RG223/U Coax							
0.216" dia.	16.5 dB / 100 ft.	53 W	12"	PE3429-12	\$44.45	\$41.34	\$38.23
			24"	PE3429-24	\$45.75	\$42.55	\$39.35
			36"	PE3429-36	\$47.05	\$43.76	\$40.46
			48"	PE3429-48	\$48.45	\$45.06	\$41.67
			60"	PE3429-60	\$49.90	\$46.41	\$42.91
			Any	PE3429-XX	See Website for Pricing		
50 Ohm, RG316/U Coax							
0.102" dia.	30 dB / 100 ft.	160 W	12"	PE3513-12	\$46.95	\$43.66	\$40.38
			24"	PE3513-24	\$49.35	\$45.90	\$42.44
			36"	PE3513-36	\$51.75	\$48.13	\$44.51
			48"	PE3513-48	\$54.15	\$50.36	\$46.57
			60"	PE3513-60	\$56.55	\$52.59	\$48.63
			Any	PE3513-XX	See Website for Pricing		
50 Ohm, RG316-DS Coax							
0.114" dia.	30 dB / 100 ft.	160 W	12"	PE3344-12	\$47.65	\$44.31	\$40.98
			24"	PE3344-24	\$50.15	\$46.64	\$43.13
			36"	PE3344-36	\$52.60	\$48.92	\$45.24
			48"	PE3344-48	\$55.15	\$51.29	\$47.43
			60"	PE3344-60	\$57.60	\$53.57	\$49.54
			Any	PE3344-XX	See Website for Pricing		
50 Ohm, RG400/U Coax							
0.195" dia.	13 dB / 100 ft.	650 W	12"	PE3003-12	\$47.75	\$44.41	\$41.07
			24"	PE3003-24	\$53.05	\$49.34	\$45.62
			36"	PE3003-36	\$58.50	\$54.41	\$50.31
			48"	PE3003-48	\$63.90	\$59.43	\$54.95
			60"	PE3003-60	\$69.35	\$64.50	\$59.64
			Any	PE3003-XX	See Website for Pricing		
See website for the following cable(s)							
50 Ohm, PE-C195 Coax				PE36475			
50 Ohm, PE-C240 Coax				PE38624			
75 Ohm, RG179B/U Coax				PE3459			
Standard Formable Cable Assemblies							
See website for the following cable(s)							
50 Ohm, PE-SR401FL Coax				PE34202			

SMA MALE TO SMA MALE RIGHT ANGLE



Cable Dia.	Atten.*	Max Power*	Length	Model No.	1-24	25-49	50-99
50 Ohm, PE-SR402FL Coax							
0.141" dia.	12 dB / 100 ft.	450 W	12"	PE3483-12	\$52.70	\$49.01	\$45.32
			24"	PE3483-24	\$58.65	\$54.54	\$50.44
			36"	PE3483-36	\$64.60	\$60.08	\$55.56
			48"	PE3483-48	\$70.60	\$65.66	\$60.72
			60"	PE3483-60	\$76.40	\$71.05	\$65.70
			Any	PE3483-XX	See Website for Pricing		
50 Ohm, PE-SR405FL Coax							
0.085" dia.	22 dB / 100 ft.	130 W	12"	PE3958-12	\$54.70	\$50.87	\$47.04
			24"	PE3958-24	\$62.55	\$58.17	\$53.79
			36"	PE3958-36	\$67.70	\$62.96	\$58.22
			48"	PE3958-48	\$73.10	\$67.98	\$62.87
			60"	PE3958-60	\$78.30	\$72.82	\$67.34
			Any	PE3958-XX	See Website for Pricing		
Standard Semirigid Cable Assemblies							
See website for the following cable(s)							
50 Ohm, PE-SR402AL Coax				PE34195			
50 Ohm, RG402/U Coax				PE3821			
50 Ohm, RG405/U Coax				PE3822			

SMA MALE TO SMA FEMALE



Cable Dia.	Atten.*	Max Power*	Length	Model No.	1-24	25-49	50-99
Precision Formable Cable Assemblies							
Please see precision section, page 6-29							
50 Ohm, PE-SR402FL Coax				PE39426			
50 Ohm, PE-SR402FLJ Jacketed Coax				PE39440			
50 Ohm, PE-SR405FL Coax				PE39418			
50 Ohm, PE-SR405FLJ Jacketed Coax				PE39432			
Standard Flexible Cable Assemblies							
50 Ohm, RG58C/U Coax							
0.195" dia.	20 dB / 100 ft.	44 W	12"	PE3078-12	\$43.95	\$40.87	\$37.80
			24"	PE3078-24	\$44.40	\$41.29	\$38.18
			36"	PE3078-36	\$44.75	\$41.62	\$38.49
			48"	PE3078-48	\$45.15	\$41.99	\$38.83
			60"	PE3078-60	\$45.60	\$42.41	\$39.22
			Any	PE3078-XX	See Website for Pricing		
50 Ohm, RG142B/U Coax							
0.195" dia.	13 dB / 100 ft.	650 W	12"	PE3611-12	\$47.75	\$44.41	\$41.07
			24"	PE3611-24	\$50.50	\$46.97	\$43.43
			36"	PE3611-36	\$53.25	\$49.52	\$45.80
			48"	PE3611-48	\$56.00	\$52.08	\$48.16
			60"	PE3611-60	\$58.70	\$54.59	\$50.48
			Any	PE3611-XX	See Website for Pricing		
See website for the following cable(s)							
50 Ohm, RG174A/U Coax				PE3715			
50 Ohm, RG178B/U Coax				PE3056			
50 Ohm, RG188A/U Coax				PE3706			
50 Ohm, RG223/U Coax							
0.216" dia.	16.5 dB / 100 ft.	53 W	12"	PE3697-12	\$44.45	\$41.34	\$38.23
			24"	PE3697-24	\$45.75	\$42.55	\$39.35
			36"	PE3697-36	\$47.05	\$43.76	\$40.46
			48"	PE3697-48	\$48.45	\$45.06	\$41.67
			60"	PE3697-60	\$49.90	\$46.41	\$42.91
			Any	PE3697-XX	See Website for Pricing		

Cable Assemblies

*Coax Performance at 1 GHz
Notes: Cable assembly max frequency may be lower than connector or coax max frequency

Continued on Next Page

ROHS & REACH COMPLIANT. CUSTOM-LENGTH CABLE ASSEMBLIES MAY BE ORDERED ON OUR WEBSITE.

Continued from Previous Page

SMA MALE TO SMA FEMALE



Cable Dia.	Atten.*	Max Power*	Length	Model No.	1-24	25-49	50-99
50 Ohm, RG316/U Coax							
0.102" dia.	30 dB / 100 ft.	160 W	12"	PE3832-12	\$44.25	\$41.15	\$38.06
			24"	PE3832-24	\$46.15	\$42.92	\$39.69
			36"	PE3832-36	\$48.55	\$45.15	\$41.75
			48"	PE3832-48	\$50.95	\$47.38	\$43.82
			60"	PE3832-60	\$53.35	\$49.62	\$45.88
Any	PE3832-XX	See Website for Pricing					
50 Ohm, RG316-DS Coax							
0.114" dia.	30 dB / 100 ft.	160 W	12"	PE3171-12	\$47.65	\$44.31	\$40.98
			24"	PE3171-24	\$50.15	\$46.64	\$43.13
			36"	PE3171-36	\$52.60	\$48.92	\$45.24
			48"	PE3171-48	\$55.15	\$51.29	\$47.43
			60"	PE3171-60	\$57.60	\$53.57	\$49.54
Any	PE3171-XX	See Website for Pricing					
50 Ohm, RG400/U Coax							
0.195" dia.	13 dB / 100 ft.	650 W	12"	PE3864-12	\$47.75	\$44.41	\$41.07
			24"	PE3864-24	\$50.50	\$46.97	\$43.43
			36"	PE3864-36	\$53.25	\$49.52	\$45.80
			48"	PE3864-48	\$57.00	\$53.01	\$49.02
			60"	PE3864-60	\$62.40	\$58.03	\$53.66
Any	PE3864-XX	See Website for Pricing					
See website for the following cable(s)							
50 Ohm, PE-C240 Coax				PE38638			
75 Ohm, RG179B/U Coax				PE3102			
50 Ohm, PE-P195 Coax				PE3160			
Standard Formable Cable Assemblies							
See website for the following cable(s)							
50 Ohm, PE-SR401FL Coax				PE34233			
50 Ohm, PE-SR402FL Coax							
0.141" dia.	12 dB / 100 ft.	450 W	12"	PE3443-12	\$41.90	\$38.97	\$36.03
			24"	PE3443-24	\$47.85	\$44.50	\$41.15
			36"	PE3443-36	\$53.80	\$50.03	\$46.27
			48"	PE3443-48	\$59.75	\$55.57	\$51.39
			60"	PE3443-60	\$65.75	\$61.15	\$56.55
Any	PE3443-XX	See Website for Pricing					
See website for the following cable(s)							
50 Ohm, PE-SR405FL Coax				PE3651			
Standard Semirigid Cable Assemblies							
See website for the following cable(s)							
50 Ohm, PE-034SR Coax				PE34226			
50 Ohm, PE-047SR Coax				PE3188			
50 Ohm, PE-SR401AL Coax				PE34230			
50 Ohm, PE-SR402AL Coax				PE34235			
50 Ohm, PE-SR405AL Coax				PE34237			
50 Ohm, RG402/U Coax							
0.141" dia.	13 dB / 100 ft.	650 W	12"	PE3823-12	\$41.55	\$38.64	\$35.73
			24"	PE3823-24	\$47.15	\$43.85	\$40.55
			36"	PE3823-36	\$52.80	\$49.10	\$45.41
			48"	PE3823-48	\$58.40	\$54.31	\$50.22
			60"	PE3823-60	\$64.05	\$59.57	\$55.08
Any	PE3823-XX	See Website for Pricing					
See website for the following cable(s)							
50 Ohm, RG405/U Coax				PE3824			

The GR874 connector or General Radio Type 874, was invented by its namesake company, General Radio Corporation in the 1960's.

SMA MALE TO SMA FEMALE BULKHEAD

SEE MOUNTING HOLE SECTION ON PAGE 246



Cable Dia.	Atten.*	Max Power*	Length	Model No.	1-24	25-49	50-99
Precision Flexible Cable Assemblies							
Please see precision section, page 6-29							
50 Ohm, 150 Series Coax				PE35475			
Precision Formable Cable Assemblies							
Please see precision section, page 6-29							
50 Ohm, PE-SR402FL Coax				PE39427			
50 Ohm, PE-SR402FLJ Jacketed Coax				PE39441			
50 Ohm, PE-SR405FL Coax				PE39419			
50 Ohm, PE-SR405FLJ Jacketed Coax				PE39433			
Standard Flexible Cable Assemblies							
See website for the following cable(s)							
50 Ohm, RG58C/U Coax				PE3956			
50 Ohm, RG142B/U Coax				PE3494			
50 Ohm, RG174A/U Coax							
0.100" dia.	31 dB / 100 ft.	16 W	12"	PE3184-12	\$46.55	\$43.29	\$40.03
			24"	PE3184-24	\$46.80	\$43.52	\$40.25
			36"	PE3184-36	\$47.05	\$43.76	\$40.46
			48"	PE3184-48	\$47.40	\$44.08	\$40.76
			60"	PE3184-60	\$47.65	\$44.31	\$40.98
Any	PE3184-XX	See Website for Pricing					
See website for the following cable(s)							
50 Ohm, RG178B/U Coax				PE3959			
50 Ohm, RG188A/U Coax							
0.110" dia.	30 dB / 100 ft.	160 W	12"	PE3051-12	\$46.90	\$43.62	\$40.33
			24"	PE3051-24	\$47.95	\$44.59	\$41.24
			36"	PE3051-36	\$48.90	\$45.48	\$42.05
			48"	PE3051-48	\$49.95	\$46.45	\$42.96
			60"	PE3051-60	\$50.85	\$47.29	\$43.73
Any	PE3051-XX	See Website for Pricing					
50 Ohm, RG223/U Coax							
0.216" dia.	16.5 dB / 100 ft.	53 W	12"	PE3553-12	\$47.05	\$43.76	\$40.46
			24"	PE3553-24	\$48.45	\$45.06	\$41.67
			36"	PE3553-36	\$49.90	\$46.41	\$42.91
			48"	PE3553-48	\$51.25	\$47.66	\$44.08
			60"	PE3553-60	\$52.55	\$48.87	\$45.19
Any	PE3553-XX	See Website for Pricing					
50 Ohm, RG316/U Coax							
0.102" dia.	30 dB / 100 ft.	160 W	12"	PE3835-12	\$46.90	\$43.62	\$40.33
			24"	PE3835-24	\$47.95	\$44.59	\$41.24
			36"	PE3835-36	\$48.90	\$45.48	\$42.05
			48"	PE3835-48	\$50.25	\$46.73	\$43.22
			60"	PE3835-60	\$52.65	\$48.96	\$45.28
Any	PE3835-XX	See Website for Pricing					
See website for the following cable(s)							
50 Ohm, RG316-DS Coax				PE3973			
50 Ohm, RG400/U Coax				PE3924			
50 Ohm, PE-C195 Coax				PE36417			
75 Ohm, RG179B/U Coax							
0.100" dia.	25 dB / 100 ft.	200 W	12"	PE3967-12	\$46.90	\$43.62	\$40.33
			24"	PE3967-24	\$47.95	\$44.59	\$41.24
			36"	PE3967-36	\$48.90	\$45.48	\$42.05
			48"	PE3967-48	\$49.95	\$46.45	\$42.96
			60"	PE3967-60	\$50.85	\$47.29	\$43.73
Any	PE3967-XX	See Website for Pricing					
See website for the following cable(s)							
50 Ohm, PE-P195 Coax				PE3799			
Standard Formable Cable Assemblies							
See website for the following cable(s)							
50 Ohm, PE-SR047FL Coax				PE34245			
50 Ohm, PE-SR401FL Coax				PE34249			

Cable Assemblies

*Coax Performance at 1 GHz
Notes: Cable assembly max frequency may be lower than connector or coax max frequency

Continued on Next Page

Continued from Previous Page

SMA MALE TO SMA FEMALE BULKHEAD

SEE MOUNTING HOLE SECTION ON PAGE 246



Cable Dia.	Atten.*	Max Power*	Length	Model No.	1-24	25-49	50-99
50 Ohm, PE-SR402FL Coax							
0.141" dia.	12 dB / 100 ft.	450 W	12"	PE3468-12	\$42.60	\$39.62	\$36.64
			24"	PE3468-24	\$48.55	\$45.15	\$41.75
			36"	PE3468-36	\$54.50	\$50.69	\$46.87
			48"	PE3468-48	\$60.45	\$56.22	\$51.99
			60"	PE3468-60	\$66.40	\$61.75	\$57.10
Any	PE3468-XX	See Website for Pricing					
50 Ohm, PE-SR405FL Coax							
0.085" dia.	22 dB / 100 ft.	130 W	12"	PE3961-12	\$47.15	\$43.85	\$40.55
			24"	PE3961-24	\$55.40	\$51.52	\$47.64
			36"	PE3961-36	\$63.60	\$59.15	\$54.70
			48"	PE3961-48	\$71.85	\$66.82	\$61.79
			60"	PE3961-60	\$80.05	\$74.45	\$68.84
Any	PE3961-XX	See Website for Pricing					
Standard Semirigid Cable Assemblies							
See website for the following cable(s)							
50 Ohm, PE-047SR Coax				PE3531			
50 Ohm, PE-SR402AL Coax				PE34252			
50 Ohm, PE-SR405AL Coax				PE34254			
50 Ohm, RG401/U Coax				PE34256			
50 Ohm, RG402/U Coax				PE3825			
50 Ohm, RG405/U Coax				PE3826			

SMA MALE TO REVERSE POLARITY SMA MALE



Cable	Model No.
Standard Flexible Cable Assemblies	
See website for the following cable(s)	
50 Ohm, RG58C/U Coax	PE34116
50 Ohm, RG142B/U Coax	PE34614
50 Ohm, RG174A/U Coax	PE34331
50 Ohm, RG223/U Coax	PE34398
50 Ohm, RG316/U Coax	PE35212

SMA MALE RIGHT ANGLE TO SMA MALE RIGHT ANGLE



Cable Dia.	Atten.*	Max Power*	Length	Model No.	1-24	25-49	50-99
Precision Flexible Cable Assemblies							
Please see precision section, page 6-29							
50 Ohm, 150 Series Coax				PE35422			
50 Ohm, 165 Non-Magnetic Series Coax				PE35424			
Precision Formable Cable Assemblies							
Please see precision section, page 6-29							
50 Ohm, PE-SR402FL Coax				PE39424			
50 Ohm, PE-SR402FLJ Jacketed Coax				PE39438			
50 Ohm, PE-SR405FL Coax				PE39416			
50 Ohm, PE-SR405FLJ Jacketed Coax				PE39430			

SMA MALE RIGHT ANGLE TO SMA MALE RIGHT ANGLE



Cable Dia.	Atten.*	Max Power*	Length	Model No.	1-24	25-49	50-99
Standard Flexible Cable Assemblies							
50 Ohm, RG58C/U Coax							
0.195" dia.	20 dB / 100 ft.	44 W	12"	PE3655-12	\$46.65	\$43.38	\$40.12
			24"	PE3655-24	\$47.00	\$43.71	\$40.42
			36"	PE3655-36	\$47.50	\$44.18	\$40.85
			48"	PE3655-48	\$47.95	\$44.59	\$41.24
			60"	PE3655-60	\$48.35	\$44.97	\$41.58
Any	PE3655-XX	See Website for Pricing					
50 Ohm, RG142B/U Coax							
0.195" dia.	13 dB / 100 ft.	650 W	12"	PE3514-12	\$50.50	\$46.97	\$43.43
			24"	PE3514-24	\$53.25	\$49.52	\$45.80
			36"	PE3514-36	\$56.00	\$52.08	\$48.16
			48"	PE3514-48	\$59.15	\$55.01	\$50.87
			60"	PE3514-60	\$63.30	\$58.87	\$54.44
Any	PE3514-XX	See Website for Pricing					
50 Ohm, RG174A/U Coax							
0.100" dia.	31 dB / 100 ft.	16 W	12"	PE3775-12	\$47.45	\$44.13	\$40.81
			24"	PE3775-24	\$47.85	\$44.50	\$41.15
			36"	PE3775-36	\$48.30	\$44.92	\$41.54
			48"	PE3775-48	\$48.75	\$45.34	\$41.93
			60"	PE3775-60	\$49.15	\$45.71	\$42.27
Any	PE3775-XX	See Website for Pricing					
50 Ohm, RG178B/U Coax							
0.750" dia.	45 dB / 100 ft.	78 W	12"	PE3876-12	\$64.70	\$60.17	\$55.64
			24"	PE3876-24	\$65.65	\$61.05	\$56.46
			36"	PE3876-36	\$66.65	\$61.98	\$57.32
			48"	PE3876-48	\$67.65	\$62.91	\$58.18
			60"	PE3876-60	\$68.65	\$63.84	\$59.04
Any	PE3876-XX	See Website for Pricing					
See website for the following cable(s)							
95 Ohm, RG180B/U Twinax				PE3141			
50 Ohm, RG188A/U Coax							
0.110" dia.	30 dB / 100 ft.	160 W	12"	PE3511-12	\$48.70	\$45.29	\$41.88
			24"	PE3511-24	\$50.40	\$46.87	\$43.34
			36"	PE3511-36	\$52.10	\$48.45	\$44.81
			48"	PE3511-48	\$53.75	\$49.99	\$46.23
			60"	PE3511-60	\$55.45	\$51.57	\$47.69
Any	PE3511-XX	See Website for Pricing					
50 Ohm, RG188-DS Coax							
0.122" dia.	30 dB / 100 ft.	160 W	12"	PE3347-12	\$50.40	\$46.87	\$43.34
			24"	PE3347-24	\$52.85	\$49.15	\$45.45
			36"	PE3347-36	\$55.40	\$51.52	\$47.64
			48"	PE3347-48	\$57.85	\$53.80	\$49.75
			60"	PE3347-60	\$60.30	\$56.08	\$51.86
Any	PE3347-XX	See Website for Pricing					
50 Ohm, RG223/U Coax							
0.216" dia.	16.5 dB / 100 ft.	53 W	12"	PE3428-12	\$47.05	\$43.76	\$40.46
			24"	PE3428-24	\$48.45	\$45.06	\$41.67
			36"	PE3428-36	\$49.90	\$46.41	\$42.91
			48"	PE3428-48	\$51.45	\$47.85	\$44.25
			60"	PE3428-60	\$53.65	\$49.89	\$46.14
Any	PE3428-XX	See Website for Pricing					
50 Ohm, RG316/U Coax							
0.102" dia.	30 dB / 100 ft.	160 W	12"	PE3515-12	\$49.40	\$45.94	\$42.48
			24"	PE3515-24	\$51.80	\$48.17	\$44.55
			36"	PE3515-36	\$54.20	\$50.41	\$46.61
			48"	PE3515-48	\$56.55	\$52.59	\$48.63
			60"	PE3515-60	\$58.95	\$54.82	\$50.70
Any	PE3515-XX	See Website for Pricing					

Cable Assemblies

*Coax Performance at 1 GHz
Notes: Cable assembly max frequency may be lower than connector or coax max frequency

Continued on Next Page

ROHS & REACH COMPLIANT. CUSTOM-LENGTH CABLE ASSEMBLIES MAY BE ORDERED ON OUR WEBSITE.

Continued from Previous Page

SMA MALE RIGHT ANGLE TO SMA MALE RIGHT ANGLE



Cable Dia.	Atten.*	Max Power*	Length	Model No.	1-24	25-49	50-99
50 Ohm, RG316-DS Coax							
0.114" dia.	30 dB / 100 ft.	160 W	12"	PE3987-12	\$50.40	\$46.87	\$43.34
			24"	PE3987-24	\$52.85	\$49.15	\$45.45
			36"	PE3987-36	\$55.40	\$51.52	\$47.64
			48"	PE3987-48	\$57.85	\$53.80	\$49.75
			60"	PE3987-60	\$60.30	\$56.08	\$51.86
			Any	PE3987-XX	See Website for Pricing		
50 Ohm, RG400/U Coax							
0.195" dia.	13 dB / 100 ft.	650 W	12"	PE3713-12	\$52.45	\$48.78	\$45.11
			24"	PE3713-24	\$57.85	\$53.80	\$49.75
			36"	PE3713-36	\$63.30	\$58.87	\$54.44
			48"	PE3713-48	\$68.75	\$63.94	\$59.13
			60"	PE3713-60	\$74.15	\$68.96	\$63.77
			Any	PE3713-XX	See Website for Pricing		
See website for the following cable(s)							
50 Ohm, PE-C195 Coax				PE35347			
50 Ohm, PE-C240 Coax				PE38920			
75 Ohm, RG59B/U Coax				PE3380			
75 Ohm, RG179B/U Coax							
0.100" dia.	25 dB / 100 ft.	200 W	12"	PE3858-12	\$48.90	\$45.48	\$42.05
			24"	PE3858-24	\$50.75	\$47.20	\$43.65
			36"	PE3858-36	\$52.65	\$48.96	\$45.28
			48"	PE3858-48	\$54.55	\$50.73	\$46.91
			60"	PE3858-60	\$56.40	\$52.45	\$48.50
			Any	PE3858-XX	See Website for Pricing		
Standard Formable Cable Assemblies							
50 Ohm, PE-SR402FL Coax							
0.141" dia.	12 dB / 100 ft.	450 W	12"	PE3417-12	\$71.20	\$66.22	\$61.23
			24"	PE3417-24	\$77.20	\$71.80	\$66.39
			36"	PE3417-36	\$83.15	\$77.33	\$71.51
			48"	PE3417-48	\$89.10	\$82.86	\$76.63
			60"	PE3417-60	\$95.05	\$88.40	\$81.74
			Any	PE3417-XX	See Website for Pricing		
50 Ohm, PE-SR405FL Coax							
0.085" dia.	22 dB / 100 ft.	130 W	12"	PE3646-12	\$74.55	\$69.33	\$64.11
			24"	PE3646-24	\$82.80	\$77.00	\$71.21
			36"	PE3646-36	\$91.00	\$84.63	\$78.26
			48"	PE3646-48	\$96.40	\$89.65	\$82.90
			60"	PE3646-60	\$101.65	\$94.53	\$87.42
			Any	PE3646-XX	See Website for Pricing		
Standard Semirigid Cable Assemblies							
See website for the following cable(s)							
50 Ohm, PE-SR402AL Coax				PE34208			
50 Ohm, PE-SR405AL Coax				PE34213			
50 Ohm, RG402/U Coax				PE3819			
50 Ohm, RG405/U Coax				PE3820			

SMA MALE RIGHT ANGLE TO SMA FEMALE BULKHEAD

SEE MOUNTING HOLE SECTION ON PAGE 246



Cable Dia.	Atten.*	Max Power*	Length	Model No.	1-24	25-49	50-99
Precision Flexible Cable Assemblies							
Please see precision section, page 6-29							
50 Ohm, 150 Series Coax				PE35421			
Precision Formable Cable Assemblies							
Please see precision section, page 6-29							
50 Ohm, PE-SR402FL Coax				PE39428			
50 Ohm, PE-SR402FLJ Jacketed Coax				PE39442			

SMA MALE RIGHT ANGLE TO SMA FEMALE BULKHEAD

SEE MOUNTING HOLE SECTION ON PAGE 246



Cable Dia.	Atten.*	Max Power*	Length	Model No.	1-24	25-49	50-99
50 Ohm, PE-SR405FL Coax							
50 Ohm, PE-SR405FL Coax				PE39420			
50 Ohm, PE-SR405FLJ Jacketed Coax				PE39434			
Standard Flexible Cable Assemblies							
See website for the following cable(s)							
50 Ohm, RG58C/U Coax				PE3156			
50 Ohm, RG142B/U Coax				PE3759			
50 Ohm, RG174A/U Coax				PE3149			
50 Ohm, RG178B/U Coax				PE3152			
50 Ohm, RG188A/U Coax				PE3050			
50 Ohm, RG188-DS Coax				PE34179			
50 Ohm, RG223/U Coax							
0.216" dia.	16.5 dB / 100 ft.	53 W	12"	PE3800-12	\$47.05	\$43.76	\$40.46
			24"	PE3800-24	\$48.45	\$45.06	\$41.67
			36"	PE3800-36	\$49.90	\$46.41	\$42.91
			48"	PE3800-48	\$51.25	\$47.66	\$44.08
			60"	PE3800-60	\$52.55	\$48.87	\$45.19
			Any	PE3800-XX	See Website for Pricing		
50 Ohm, RG316/U Coax							
0.102" dia.	30 dB / 100 ft.	160 W	12"	PE3836-12	\$49.90	\$46.41	\$42.91
			24"	PE3836-24	\$52.30	\$48.64	\$44.98
			36"	PE3836-36	\$54.70	\$50.87	\$47.04
			48"	PE3836-48	\$57.10	\$53.10	\$49.11
			60"	PE3836-60	\$59.45	\$55.29	\$51.13
			Any	PE3836-XX	See Website for Pricing		
See website for the following cable(s)							
50 Ohm, RG316-DS Coax				PE34061			
50 Ohm, RG400/U Coax				PE34192			
Standard Formable Cable Assemblies							
See website for the following cable(s)							
50 Ohm, PE-SR402FL Coax				PE34299			
50 Ohm, PE-SR405FL Coax				PE34313			
Standard Semirigid Cable Assemblies							
See website for the following cable(s)							
50 Ohm, PE-SR405AL Coax				PE34311			

SMA FEMALE TO SMA FEMALE



Cable	Model No.
Standard Flexible Cable Assemblies	
See website for the following cable(s)	
50 Ohm, RG58C/U Coax	PE33547
50 Ohm, RG174A/U Coax	PE33120
50 Ohm, RG223/U Coax	PE33254
50 Ohm, RG316/U Coax	PE33047
Standard Formable Cable Assemblies	
See website for the following cable(s)	
50 Ohm, PE-SR047FL Coax	PE34833
50 Ohm, PE-SR402FL Coax	PE33964
50 Ohm, PE-SR405FL Coax	PE34292
Standard Semirigid Cable Assemblies	
See website for the following cable(s)	
50 Ohm, PE-020SR Coax	PE34917
50 Ohm, PE-034SR Coax	PE34405
50 Ohm, PE-047SR Coax	PE3758
50 Ohm, PE-SR047AL Coax	PE34835
50 Ohm, PE-SR402AL Coax	PE34836
50 Ohm, PE-SR405AL Coax	PE34834
50 Ohm, RG401/U Coax	PE3521

Cable Assemblies

*Coax Performance at 1 GHz
Notes: Cable assembly max frequency may be lower than connector or coax max frequency

Continued on Next Page

Continued from Previous Page

SMA FEMALE TO SMA FEMALE



Cable Model No.

50 Ohm, RG402/U Coax	PE3931	1
50 Ohm, RG405/U Coax	PE3109	2

SMA FEMALE BULKHEAD TO SMA FEMALE BULKHEAD

SEE MOUNTING HOLE SECTION ON PAGE 246



Cable Model No.

Standard Flexible Cable Assemblies

See website for the following cable(s)

50 Ohm, RG58C/U Coax	PE35404	3
50 Ohm, RG174A/U Coax	PE33382	4
50 Ohm, RG316/U Coax	PE33158	5
50 Ohm, RG316-DS Coax	PE38184	6
50 Ohm, RG400/U Coax	PE36228	7

Standard Formable Cable Assemblies

See website for the following cable(s)

50 Ohm, PE-SR047FL Coax	PE34709	8
50 Ohm, PE-SR402FL Coax	PE33864	9
50 Ohm, PE-SR405FL Coax	PE34070	10

Standard Semirigid Cable Assemblies

See website for the following cable(s)

50 Ohm, PE-020SR Coax	PE3932	11
50 Ohm, PE-034SR Coax	PE3520	12
50 Ohm, PE-047SR Coax	PE33789	13
50 Ohm, PE-SR405AL Coax	PE34071	14
50 Ohm, RG402/U Coax	PE33518	15
50 Ohm, RG405/U Coax	PE33176	16

SMA FEMALE 2 HOLE PANEL TO SMA FEMALE 2 HOLE PANEL



Cable Model No.

Standard Formable Cable Assemblies

See website for the following cable(s)

50 Ohm, PE-SR402FL Coax	PE35108	17
-------------------------	---------	----

Standard Semirigid Cable Assemblies

See website for the following cable(s)

50 Ohm, PE-047SR Coax	PE35064	18
50 Ohm, RG405/U Coax	PE33191	19

SMA FEMALE 4 HOLE PANEL TO SMA FEMALE 4 HOLE PANEL



Cable Model No.

Standard Formable Cable Assemblies

See website for the following cable(s)

50 Ohm, PE-SR047FL Coax	PE35112	20
50 Ohm, PE-SR402FL Coax	PE35110	21
50 Ohm, PE-SR405FL Coax	PE35116	22

Standard Semirigid Cable Assemblies

See website for the following cable(s)

50 Ohm, PE-047SR Coax	PE35118	23
50 Ohm, RG402/U Coax	PE33502	24

SMA FEMALE 4 HOLE PANEL TO SMA FEMALE 4 HOLE PANEL



Cable Model No.

50 Ohm, RG405/U Coax	PE3223	25
----------------------	--------	----

SMA MALE TO 2.4MM MALE



Cable Model No.

Standard Semirigid Cable Assemblies

See website for the following cable(s)

50 Ohm, RG405/U Coax	PE35666	26
----------------------	---------	----

SMA MALE TO SSMA MALE



Cable Model No.

Standard Flexible Cable Assemblies

See website for the following cable(s)

50 Ohm, RG174A/U Coax	PE35430	27
50 Ohm, RG178B/U Coax	PE3058	28
50 Ohm, RG316/U Coax	PE3669	29

SMA MALE TO N MALE



Cable Dia.	Atten.*	Max Power*	Length	Model No.	1-24	25-49	50-99
------------	---------	------------	--------	-----------	------	-------	-------

Precision Flexible Cable Assemblies

Please see precision section, page 6-29

50 Ohm, 150 Series Coax	PE33231	30
50 Ohm, 165 Non-Magnetic Series Coax	PE33233	31
50 Ohm, 300 Series Coax	PE304	32

Standard Flexible Cable Assemblies

See website for the following cable(s)

52 Ohm, RG8A/U Coax	PE3323	33
53.5 Ohm, RG55B/U Coax	PE3654	34

0.195" dia.	20 dB / 100 ft.	44 W	12"	PE3662-12	\$33.85	\$31.48	\$29.11
			24"	PE3662-24	\$34.40	\$31.99	\$29.58
			36"	PE3662-36	\$34.90	\$32.46	\$30.01
			48"	PE3662-48	\$35.45	\$32.97	\$30.49
			60"	PE3662-60	\$36.00	\$33.48	\$30.96
Any	PE3662-XX	See Website for Pricing					

0.195" dia.	13 dB / 100 ft.	650 W	12"	PE3568-12	\$34.80	\$32.36	\$29.93
			24"	PE3568-24	\$38.95	\$36.22	\$33.50
			36"	PE3568-36	\$43.10	\$40.08	\$37.07
			48"	PE3568-48	\$47.20	\$43.90	\$40.59
			60"	PE3568-60	\$51.35	\$47.76	\$44.16
Any	PE3568-XX	See Website for Pricing					

0.100" dia.	31 dB / 100 ft.	16 W	12"	PE3291-12	\$38.70	\$35.99	\$33.28
			24"	PE3291-24	\$39.10	\$36.36	\$33.63
			36"	PE3291-36	\$39.55	\$36.78	\$34.01
			48"	PE3291-48	\$40.00	\$37.20	\$34.40
			60"	PE3291-60	\$40.40	\$37.57	\$34.74
Any	PE3291-XX	See Website for Pricing					

Cable Assemblies

*Coax Performance at 1 GHz
Notes: Cable assembly max frequency may be lower than connector or coax max frequency

Continued on Next Page

ROHS & REACH COMPLIANT. CUSTOM-LENGTH CABLE ASSEMBLIES MAY BE ORDERED ON OUR WEBSITE.

Continued from Previous Page

SMA MALE TO N MALE							
							
Cable Dia.	Atten.*	Max Power*	Length	Model No.	1-24	25-49	50-99
See website for the following cable(s)							
50 Ohm, RG178B/U Coax				PE3321			
50 Ohm, RG188A/U Coax				PE3911			
50 Ohm, RG214/U Coax							
0.425" dia.	9 dB / 100 ft.	190 W	12"	PE3422-12	\$95.25	\$88.58	\$81.92
			24"	PE3422-24	\$101.00	\$93.93	\$86.86
			36"	PE3422-36	\$106.75	\$99.28	\$91.81
			48"	PE3422-48	\$112.50	\$104.63	\$96.75
			60"	PE3422-60	\$118.25	\$109.97	\$101.70
Any			PE3422-XX	See Website for Pricing			
50 Ohm, RG223/U Coax							
0.216" dia.	16.5 dB / 100 ft.	53 W	12"	PE3519-12	\$32.85	\$30.55	\$28.25
			24"	PE3519-24	\$35.10	\$32.64	\$30.19
			36"	PE3519-36	\$37.30	\$34.69	\$32.08
			48"	PE3519-48	\$39.50	\$36.74	\$33.97
			60"	PE3519-60	\$41.70	\$38.78	\$35.86
Any			PE3519-XX	See Website for Pricing			
50 Ohm, RG316/U Coax							
0.102" dia.	30 dB / 100 ft.	160 W	12"	PE3234-12	\$40.65	\$37.80	\$34.96
			24"	PE3234-24	\$43.05	\$40.04	\$37.02
			36"	PE3234-36	\$45.45	\$42.27	\$39.09
			48"	PE3234-48	\$47.80	\$44.45	\$41.11
			60"	PE3234-60	\$50.20	\$46.69	\$43.17
Any			PE3234-XX	See Website for Pricing			
50 Ohm, RG316-DS Coax							
0.114" dia.	30 dB / 100 ft.	160 W	12"	PE3957-12	\$42.35	\$39.39	\$36.42
			24"	PE3957-24	\$44.80	\$41.66	\$38.53
			36"	PE3957-36	\$47.25	\$43.94	\$40.64
			48"	PE3957-48	\$49.80	\$46.31	\$42.83
			60"	PE3957-60	\$52.25	\$48.59	\$44.94
Any			PE3957-XX	See Website for Pricing			
See website for the following cable(s)							
50 Ohm, RG393/U Coax				PE3302			
50 Ohm, RG400/U Coax							
0.195" dia.	13 dB / 100 ft.	650 W	12"	PE3614-12	\$40.50	\$37.67	\$34.83
			24"	PE3614-24	\$45.95	\$42.73	\$39.52
			36"	PE3614-36	\$51.35	\$47.76	\$44.16
			48"	PE3614-48	\$56.80	\$52.82	\$48.85
			60"	PE3614-60	\$62.20	\$57.85	\$53.49
Any			PE3614-XX	See Website for Pricing			
See website for the following cable(s)							
50 Ohm, PE-C195 Coax				PE35981			
50 Ohm, PE-C240 Coax							
0.240" dia.	8 dB / 100 ft.	250 W	12"	PE38645-12	\$42.35	\$39.39	\$36.42
			24"	PE38645-24	\$44.70	\$41.57	\$38.44
			36"	PE38645-36	\$47.05	\$43.76	\$40.46
			48"	PE38645-48	\$49.35	\$45.90	\$42.44
			60"	PE38645-60	\$51.70	\$48.08	\$44.46
Any			PE38645-XX	See Website for Pricing			
50 Ohm, PE-P195 Coax							
0.195" dia.	12.5 dB / 100 ft.	650 W	12"	PE3318-12	\$54.60	\$50.78	\$46.96
			24"	PE3318-24	\$58.30	\$54.22	\$50.14
			36"	PE3318-36	\$62.05	\$57.71	\$53.36
			48"	PE3318-48	\$65.75	\$61.15	\$56.55
			60"	PE3318-60	\$69.45	\$64.59	\$59.73
Any			PE3318-XX	See Website for Pricing			
Standard Formable Cable Assemblies							
See website for the following cable(s)							
50 Ohm, PE-SR047FL Coax				PE34268			
50 Ohm, PE-SR401FL Coax				PE34263			

SMA MALE TO N MALE							
							
Cable Dia.	Atten.*	Max Power*	Length	Model No.	1-24	25-49	50-99
50 Ohm, PE-SR402FL Coax							
0.141" dia.	12 dB / 100 ft.	450 W	12"	PE3448-12	\$52.40	\$48.73	\$45.06
			24"	PE3448-24	\$56.10	\$52.17	\$48.25
			36"	PE3448-36	\$61.40	\$57.10	\$52.80
			48"	PE3448-48	\$67.35	\$62.64	\$57.92
			60"	PE3448-60	\$73.30	\$68.17	\$63.04
Any			PE3448-XX	See Website for Pricing			
See website for the following cable(s)							
50 Ohm, PE-SR405FL Coax				PE3657			
Standard Semirigid Cable Assemblies							
See website for the following cable(s)							
50 Ohm, PE-SR402AL Coax				PE34265			
50 Ohm, PE-SR405AL Coax				PE34270			
50 Ohm, RG401/U Coax				PE33001			
50 Ohm, RG402/U Coax							
0.141" dia.	13 dB / 100 ft.	650 W	12"	PE3887-12	\$49.15	\$45.71	\$42.27
			24"	PE3887-24	\$54.75	\$50.92	\$47.09
			36"	PE3887-36	\$60.40	\$56.17	\$51.94
			48"	PE3887-48	\$66.00	\$61.38	\$56.76
			60"	PE3887-60	\$71.60	\$66.59	\$61.58
Any			PE3887-XX	See Website for Pricing			
See website for the following cable(s)							
50 Ohm, RG405/U Coax				PE3828			

SMA MALE TO N FEMALE BULKHEAD							
SEE MOUNTING HOLE SECTION ON PAGE 246							
							
Cable Dia.	Atten.*	Max Power*	Length	Model No.	1-24	25-49	50-99
Precision Flexible Cable Assemblies							
Please see precision section, page 6-29							
50 Ohm, 150 Series Coax				PE35954			
50 Ohm, 165 Non-Magnetic Series Coax				PE35958			
Precision Formable Cable Assemblies							
Please see precision section, page 6-29							
50 Ohm, PE-SR402FL Coax				PE39455			
50 Ohm, PE-SR402FLJ Jacketed Coax				PE39469			
Please see precision section, page 6-29							
50 Ohm, PE-SR405FL Coax				PE39447			
50 Ohm, PE-SR405FLJ Jacketed Coax				PE39461			
Standard Flexible Cable Assemblies							
Please see precision section, page 6-29							
53.5 Ohm, RG55B/U Coax				PE34169			
See website for the following cable(s)							
50 Ohm, RG58C/U Coax				PE3013			
50 Ohm, RG142B/U Coax							
0.195" dia.	13 dB / 100 ft.	650 W	12"	PE3345-12	\$50.50	\$46.97	\$43.43
			24"	PE3345-24	\$53.25	\$49.52	\$45.80
			36"	PE3345-36	\$56.00	\$52.08	\$48.16
			48"	PE3345-48	\$58.70	\$54.59	\$50.48
			60"	PE3345-60	\$61.45	\$57.15	\$52.85
Any			PE3345-XX	See Website for Pricing			
See website for the following cable(s)							
50 Ohm, RG174A/U Coax				PE34171			
50 Ohm, RG178B/U Coax				PE34174			
50 Ohm, RG214/U Coax				PE33481			

Cable Assemblies

*Coax Performance at 1 GHz
Notes: Cable assembly max frequency may be lower than connector or coax max frequency

Continued on Next Page

Continued from Previous Page

SMA MALE TO N FEMALE BULKHEAD

SEE MOUNTING HOLE SECTION ON PAGE 246



Cable Dia.	Atten.*	Max Power*	Length	Model No.	1-24	25-49	50-99
50 Ohm, RG223/U Coax							
0.216" dia.	16.5 dB / 100 ft.	53 W	12"	PE3193-12	\$47.05	\$43.76	\$40.46
			24"	PE3193-24	\$48.45	\$45.06	\$41.67
			36"	PE3193-36	\$49.90	\$46.41	\$42.91
			48"	PE3193-48	\$51.25	\$47.66	\$44.08
			60"	PE3193-60	\$52.55	\$48.87	\$45.19
			Any	PE3193-XX	See Website for Pricing		
50 Ohm, RG316/U Coax							
0.102" dia.	30 dB / 100 ft.	160 W	12"	PE33555-12	\$48.70	\$45.29	\$41.88
			24"	PE33555-24	\$51.10	\$47.52	\$43.95
			36"	PE33555-36	\$53.50	\$49.76	\$46.01
			48"	PE33555-48	\$55.85	\$51.94	\$48.03
			60"	PE33555-60	\$58.25	\$54.17	\$50.10
			Any	PE33555-XX	See Website for Pricing		
See website for the following cable(s)							
50 Ohm, RG316-DS Coax				PE33929			
50 Ohm, RG400/U Coax							
0.195" dia.	13 dB / 100 ft.	650 W	12"	PE33117-12	\$50.50	\$46.97	\$43.43
			24"	PE33117-24	\$53.25	\$49.52	\$45.80
			36"	PE33117-36	\$56.00	\$52.08	\$48.16
			48"	PE33117-48	\$59.75	\$55.57	\$51.39
			60"	PE33117-60	\$65.15	\$60.59	\$56.03
			Any	PE33117-XX	See Website for Pricing		
See website for the following cable(s)							
50 Ohm, PE-P195 Coax				PE34178			
Standard Formable Cable Assemblies							
See website for the following cable(s)							
50 Ohm, PE-SR401FL Coax				PE34163			
50 Ohm, PE-SR402FL Coax							
0.141" dia.	12 dB / 100 ft.	450 W	12"	PE33996-12	\$87.90	\$81.75	\$75.59
			24"	PE33996-24	\$91.60	\$85.19	\$78.78
			36"	PE33996-36	\$95.35	\$88.68	\$82.00
			48"	PE33996-48	\$99.10	\$92.16	\$85.23
			60"	PE33996-60	\$102.75	\$95.56	\$88.37
			Any	PE33996-XX	See Website for Pricing		
See website for the following cable(s)							
50 Ohm, PE-SR405FL Coax				PE33844			
Standard Semirigid Cable Assemblies							
See website for the following cable(s)							
50 Ohm, RG402/U Coax				PE3769			
50 Ohm, RG405/U Coax				PE3367			

SMA MALE TO TNC MALE



Cable Dia.	Atten.*	Max Power*	Length	Model No.	1-24	25-49	50-99
Precision Flexible Cable Assemblies							
Please see precision section, page 6-29							
50 Ohm, 150 Series Coax				PE35419			
50 Ohm, 300 Series Coax				PE308			
Standard Flexible Cable Assemblies							
50 Ohm, RG58C/U Coax							
0.195" dia.	20 dB / 100 ft.	44 W	12"	PE3154-12	\$32.75	\$30.46	\$28.17
			24"	PE3154-24	\$33.20	\$30.88	\$28.55
			36"	PE3154-36	\$33.65	\$31.29	\$28.94
			48"	PE3154-48	\$34.05	\$31.67	\$29.28
			60"	PE3154-60	\$34.45	\$32.04	\$29.63
			Any	PE3154-XX	See Website for Pricing		

SMA MALE TO TNC MALE



Cable Dia.	Atten.*	Max Power*	Length	Model No.	1-24	25-49	50-99
50 Ohm, RG142B/U Coax							
0.195" dia.	13 dB / 100 ft.	650 W	12"	PE3664-12	\$33.00	\$30.69	\$28.38
			24"	PE3664-24	\$37.15	\$34.55	\$31.95
			36"	PE3664-36	\$41.30	\$38.41	\$35.52
			48"	PE3664-48	\$45.45	\$42.27	\$39.09
			60"	PE3664-60	\$49.60	\$46.13	\$42.66
			Any	PE3664-XX	See Website for Pricing		
50 Ohm, RG174A/U Coax							
0.100" dia.	31 dB / 100 ft.	16 W	12"	PE3178-12	\$41.10	\$38.22	\$35.35
			24"	PE3178-24	\$41.55	\$38.64	\$35.73
			36"	PE3178-36	\$42.00	\$39.06	\$36.12
			48"	PE3178-48	\$42.40	\$39.43	\$36.46
			60"	PE3178-60	\$42.85	\$39.85	\$36.85
			Any	PE3178-XX	See Website for Pricing		
See website for the following cable(s)							
50 Ohm, RG188A/U Coax				PE33361			
50 Ohm, RG213/U Coax				PE33673			
50 Ohm, RG214/U Coax							
0.425" dia.	9 dB / 100 ft.	190 W	12"	PE3176-12	\$103.15	\$95.93	\$88.71
			24"	PE3176-24	\$108.90	\$101.28	\$93.65
			36"	PE3176-36	\$114.65	\$106.62	\$98.60
			48"	PE3176-48	\$120.40	\$111.97	\$103.54
			60"	PE3176-60	\$126.15	\$117.32	\$108.49
			Any	PE3176-XX	See Website for Pricing		
50 Ohm, RG223/U Coax							
0.216" dia.	16.5 dB / 100 ft.	53 W	12"	PE3535-12	\$32.75	\$30.46	\$28.17
			24"	PE3535-24	\$34.15	\$31.76	\$29.37
			36"	PE3535-36	\$35.55	\$33.06	\$30.57
			48"	PE3535-48	\$37.70	\$35.06	\$32.42
			60"	PE3535-60	\$39.95	\$37.15	\$34.36
			Any	PE3535-XX	See Website for Pricing		
50 Ohm, RG316/U Coax							
0.102" dia.	30 dB / 100 ft.	160 W	12"	PE3174-12	\$43.10	\$40.08	\$37.07
			24"	PE3174-24	\$45.45	\$42.27	\$39.09
			36"	PE3174-36	\$47.85	\$44.50	\$41.15
			48"	PE3174-48	\$50.25	\$46.73	\$43.22
			60"	PE3174-60	\$52.65	\$48.96	\$45.28
			Any	PE3174-XX	See Website for Pricing		
See website for the following cable(s)							
50 Ohm, RG316-DS Coax				PE34246			
50 Ohm, RG393/U Coax				PE34253			
50 Ohm, RG400/U Coax							
0.195" dia.	13 dB / 100 ft.	650 W	12"	PE33948-12	\$38.70	\$35.99	\$33.28
			24"	PE33948-24	\$44.15	\$41.06	\$37.97
			36"	PE33948-36	\$49.60	\$46.13	\$42.66
			48"	PE33948-48	\$55.00	\$51.15	\$47.30
			60"	PE33948-60	\$60.45	\$56.22	\$51.99
			Any	PE33948-XX	See Website for Pricing		
See website for the following cable(s)							
50 Ohm, PE-C195 Coax				PE36058			
50 Ohm, PE-C240 Coax				PE38642			
75 Ohm, RG59B/U Coax				PE36848			
Standard Formable Cable Assemblies							
See website for the following cable(s)							
50 Ohm, PE-SR402FL Coax				PE33928			
Standard Semirigid Cable Assemblies							
See website for the following cable(s)							
50 Ohm, PE-SR402AL Coax				PE34406			
50 Ohm, PE-SR405AL Coax				PE34414			

Cable Assemblies

*Coax Performance at 1 GHz
Notes: Cable assembly max frequency may be lower than connector or coax max frequency

SMA MALE TO TNC MALE RIGHT ANGLE



Cable	Model No.
Precision Flexible Cable Assemblies	
Please see precision section, page 6-29	
50 Ohm, 300 Series Coax	PE309

1

SMA MALE TO TNC FEMALE BULKHEAD

SEE MOUNTING HOLE SECTION ON PAGE 246



Cable	Model No.
Precision Formable Cable Assemblies	
Please see precision section, page 6-29	
50 Ohm, PE-SR402FL Coax	PE39483
50 Ohm, PE-SR402FLJ Jacketed Coax	PE39497
50 Ohm, PE-SR405FL Coax	PE39475
50 Ohm, PE-SR405FLJ Jacketed Coax	PE39489

2
3
4
5

SMA MALE TO REVERSE POLARITY TNC MALE



Cable	Model No.
Standard Flexible Cable Assemblies	
See website for the following cable(s)	
50 Ohm, RG58C/U Coax	PE34853
50 Ohm, RG142B/U Coax	PE34854
50 Ohm, RG223/U Coax	PE34397
50 Ohm, RG316/U Coax	PE34396
50 Ohm, RG400/U Coax	PE35246
50 Ohm, PE-C195 Coax	PE37120

6
7
8
9
10
11

SMA MALE TO SMC PLUG



Cable	Model No.
Standard Flexible Cable Assemblies	
See website for the following cable(s)	
50 Ohm, RG58C/U Coax	PE3210
50 Ohm, RG174A/U Coax	PE3944
50 Ohm, RG178B/U Coax	PE3561
50 Ohm, RG188-DS Coax	PE34458
50 Ohm, RG316/U Coax	PE3809
50 Ohm, RG316-DS Coax	PE34456
50 Ohm, RG400/U Coax	PE34454

12
13
14
15
16
17
18

SMA MALE TO QMA MALE



Cable	Model No.
Standard Flexible Cable Assemblies	
See website for the following cable(s)	
50 Ohm, RG58C/U Coax	PE38275

19

SMA MALE TO QMA MALE



Cable Dia.	Atten.*	Max Power*	Length	Model No.	1-24	25-49	50-99
50 Ohm, RG316/U Coax							
0.102" dia.	30 dB / 100 ft.	160 W	12"	PE38273-12	\$42.90	\$39.90	\$36.89
			24"	PE38273-24	\$45.25	\$42.08	\$38.92
			36"	PE38273-36	\$47.65	\$44.31	\$40.98
			48"	PE38273-48	\$50.05	\$46.55	\$43.04
			60"	PE38273-60	\$52.45	\$48.78	\$45.11
Any	PE38273-XX	See Website for Pricing					
See website for the following cable(s)							
				50 Ohm, RG316-DS Coax	PE38274		
				50 Ohm, PE-C195 Coax	PE38116		

20
21
22

SMA MALE TO SMP FEMALE



Cable Dia.	Atten.*	Max Power*	Length	Model No.	1-24	25-49	50-99
Standard Formable Cable Assemblies							
50 Ohm, PE-SR047FL Coax							
0.047" dia.	40 dB / 100 ft.	32 W	12"	PE36164-12	\$65.95	\$61.33	\$56.72
			24"	PE36164-24	\$71.60	\$66.59	\$61.58
			36"	PE36164-36	\$77.25	\$71.84	\$66.44
			48"	PE36164-48	\$82.95	\$77.14	\$71.34
			60"	PE36164-60	\$88.60	\$82.40	\$76.20
Any	PE36164-XX	See Website for Pricing					
50 Ohm, PE-SR405FL Coax							
0.085" dia.	22 dB / 100 ft.	130 W	12"	PE36168-12	\$60.30	\$56.08	\$51.86
			24"	PE36168-24	\$68.50	\$63.71	\$58.91
			36"	PE36168-36	\$76.75	\$71.38	\$66.01
			48"	PE36168-48	\$84.95	\$79.00	\$73.06
			60"	PE36168-60	\$93.20	\$86.68	\$80.15
Any	PE36168-XX	See Website for Pricing					
Standard Semirigid Cable Assemblies							
See website for the following cable(s)							
				50 Ohm, PE-047SR Coax	PE36162		
				50 Ohm, RG405/U Coax	PE36166		

23
24
25
26

SMA MALE TO UMCX PLUG RIGHT ANGLE



Cable Dia.	Atten.*	Max Power*	Length	Model No.	1-24	25-49	50-99
Standard Flexible Cable Assemblies							
50 Ohm, RG178B/U Coax							
0.750" dia.	45 dB / 100 ft.	78 W	3"	PE38881-3	\$49.55	\$46.08	\$42.61
			6"	PE38881-6	\$49.55	\$46.08	\$42.61
			9"	PE38881-9	\$49.55	\$46.08	\$42.61
			12"	PE38881-12	\$50.25	\$46.73	\$43.22
			18"	PE38881-18	\$52.45	\$48.78	\$45.11
24"	PE38881-24	\$54.65	\$50.82	\$47.00			
Any	PE38881-XX	See Website for Pricing					

27

The SMA connector or "Sub-Miniature version A" was invented in the 1960's.

*Coax Performance at 1 GHz
Notes: Cable assembly max frequency may be lower than connector or coax max frequency

Cable Assemblies

*Coax Performance at 1 GHz
Notes: Cable assembly max frequency may be lower than connector or coax max frequency

SMA MALE TO MMCX PLUG							
							
Cable Dia.	Atten.*	Max Power*	Length	Model No.	1-24	25-49	50-99
Standard Flexible Cable Assemblies							
50 Ohm, RG174A/U Coax							
0.100" dia.	31 dB / 100 ft.	16 W	12"	PE34069-12	\$38.10	\$35.43	\$32.77
			24"	PE34069-24	\$38.50	\$35.81	\$33.11
			36"	PE34069-36	\$38.95	\$36.22	\$33.50
			48"	PE34069-48	\$39.35	\$36.60	\$33.84
			60"	PE34069-60	\$39.80	\$37.01	\$34.23
			Any	PE34069-XX	See Website for Pricing		
50 Ohm, RG178B/U Coax							
0.750" dia.	45 dB / 100 ft.	78 W	12"	PE34374-12	\$40.35	\$37.53	\$34.70
			24"	PE34374-24	\$41.10	\$38.22	\$35.35
			36"	PE34374-36	\$41.80	\$38.87	\$35.95
			48"	PE34374-48	\$42.55	\$39.57	\$36.59
			60"	PE34374-60	\$43.25	\$40.22	\$37.20
Any	PE34374-XX	See Website for Pricing					
See website for the following cable(s)							
50 Ohm, RG188A/U Coax				PE34887			
50 Ohm, RG316/U Coax							
0.102" dia.	30 dB / 100 ft.	160 W	12"	PE34122-12	\$40.05	\$37.25	\$34.44
			24"	PE34122-24	\$42.45	\$39.48	\$36.51
			36"	PE34122-36	\$44.80	\$41.66	\$38.53
			48"	PE34122-48	\$47.20	\$43.90	\$40.59
			60"	PE34122-60	\$49.60	\$46.13	\$42.66
Any	PE34122-XX	See Website for Pricing					

SMA MALE TO MMCX PLUG RIGHT ANGLE							
							
Cable Dia.	Atten.*	Max Power*	Length	Model No.	1-24	25-49	50-99
Standard Flexible Cable Assemblies							
50 Ohm, RG178B/U Coax							
0.750" dia.	45 dB / 100 ft.	78 W	12"	PE34777-12	\$46.10	\$42.87	\$39.65
			24"	PE34777-24	\$46.85	\$43.57	\$40.29
			36"	PE34777-36	\$47.60	\$44.27	\$40.94
			48"	PE34777-48	\$48.30	\$44.92	\$41.54
			60"	PE34777-60	\$49.05	\$45.62	\$42.18
			Any	PE34777-XX	See Website for Pricing		

SMA MALE TO SMB PLUG							
							
Cable Dia.	Atten.*	Max Power*	Length	Model No.	1-24	25-49	50-99
Standard Flexible Cable Assemblies							
See website for the following cable(s)							
50 Ohm, PE-B100 Coax				PE34455			
50 Ohm, RG58C/U Coax							
0.195" dia.	20 dB / 100 ft.	44 W	12"	PE3172-12	\$37.15	\$34.55	\$31.95
			24"	PE3172-24	\$37.50	\$34.88	\$32.25
			36"	PE3172-36	\$37.90	\$35.25	\$32.59
			48"	PE3172-48	\$38.35	\$35.67	\$32.98
			60"	PE3172-60	\$38.85	\$36.13	\$33.41
Any	PE3172-XX	See Website for Pricing					
See website for the following cable(s)							
50 Ohm, RG142B/U Coax				PE3181			

SMA MALE TO SMB PLUG							
							
Cable Dia.	Atten.*	Max Power*	Length	Model No.	1-24	25-49	50-99
Standard Flexible Cable Assemblies							
50 Ohm, RG174A/U Coax							
0.100" dia.	31 dB / 100 ft.	16 W	12"	PE3908-12	\$37.10	\$34.50	\$31.91
			24"	PE3908-24	\$37.30	\$34.69	\$32.08
			36"	PE3908-36	\$37.55	\$34.92	\$32.29
			48"	PE3908-48	\$37.80	\$35.15	\$32.51
			60"	PE3908-60	\$38.15	\$35.48	\$32.81
			Any	PE3908-XX	See Website for Pricing		
See website for the following cable(s)							
50 Ohm, RG178B/U Coax				PE3548			
50 Ohm, RG188A/U Coax							
0.110" dia.	30 dB / 100 ft.	160 W	12"	PE3755-12	\$37.40	\$34.78	\$32.16
			24"	PE3755-24	\$38.40	\$35.71	\$33.02
			36"	PE3755-36	\$39.65	\$36.87	\$34.10
			48"	PE3755-48	\$41.35	\$38.46	\$35.56
			60"	PE3755-60	\$43.05	\$40.04	\$37.02
			Any	PE3755-XX	See Website for Pricing		
See website for the following cable(s)							
50 Ohm, RG188-DS Coax				PE3722			
50 Ohm, RG223/U Coax							
0.216" dia.	16.5 dB / 100 ft.	53 W	12"	PE3187-12	\$37.55	\$34.92	\$32.29
			24"	PE3187-24	\$38.95	\$36.22	\$33.50
			36"	PE3187-36	\$40.25	\$37.43	\$34.62
			48"	PE3187-48	\$41.60	\$38.69	\$35.78
			60"	PE3187-60	\$43.35	\$40.32	\$37.28
			Any	PE3187-XX	See Website for Pricing		
50 Ohm, RG316/U Coax							
0.102" dia.	30 dB / 100 ft.	160 W	12"	PE3810-12	\$37.40	\$34.78	\$32.16
			24"	PE3810-24	\$39.40	\$36.64	\$33.88
			36"	PE3810-36	\$41.75	\$38.83	\$35.91
			48"	PE3810-48	\$44.15	\$41.06	\$37.97
			60"	PE3810-60	\$46.55	\$43.29	\$40.03
			Any	PE3810-XX	See Website for Pricing		
50 Ohm, RG316-DS Coax							
0.114" dia.	30 dB / 100 ft.	160 W	12"	PE33657-12	\$40.90	\$38.04	\$35.17
			24"	PE33657-24	\$43.35	\$40.32	\$37.28
			36"	PE33657-36	\$45.80	\$42.59	\$39.39
			48"	PE33657-48	\$48.30	\$44.92	\$41.54
			60"	PE33657-60	\$50.75	\$47.20	\$43.65
			Any	PE33657-XX	See Website for Pricing		
See website for the following cable(s)							
50 Ohm, RG400/U Coax				PE34452			
Standard Formable Cable Assemblies							
See website for the following cable(s)							
50 Ohm, PE-SR405FL Coax				PE34764			

SMA MALE TO FAKRA PLUG							
SEE FAKRA SPECIFICATION ON PAGE 243							
							
Cable	Model No.						
Standard Flexible Cable Assemblies							
See website for the following cable(s)							
50 Ohm, RG174A/U Coax	PE39197A						
	PE39197B						
	PE39197C						
	PE39197D						
	PE39197H						
	PE39197I						
	PE39197K						
	PE39197Z						

Continued on Next Page

Continued from Previous Page

SMA MALE TO FAKRA PLUG

SEE FAKRA SPECIFICATION ON PAGE 243



Cable	Model No.
50 Ohm, RG316/U Coax	PE39343A
	PE39343B
	PE39343C
	PE39343D
	PE39343H
	PE39343I
50 Ohm, PE-C100 Coax	PE39343K
	PE39343Z
	PE39342A
	PE39342B
	PE39342C
	PE39342D
PE39342H	
PE39342I	
PE39342K	
PE39342Z	

SMA MALE TO FAKRA JACK

SEE FAKRA SPECIFICATION ON PAGE 243



Cable	Model No.
50 Ohm, RG174A/U Coax	PE39199A
	PE39199B
	PE39199C
	PE39199D
	PE39199H
	PE39199I
50 Ohm, RG316/U Coax	PE39199K
	PE39199Z
	PE39348A
	PE39348B
	PE39348C
	PE39348D
50 Ohm, PE-C100 Coax	PE39348H
	PE39348I
	PE39348K
	PE39348Z
	PE39347A
	PE39347B
PE39347C	
PE39347D	
PE39347H	
PE39347I	
PE39347K	
PE39347Z	

SMA MALE TO MC-CARD PLUG



Cable	Model No.
50 Ohm, RG316/U Coax	PE36108

SMA MALE TO BNC MALE



Cable Dia.	Atten.*	Max Power*	Length	Model No.	1-24	25-49	50-99
Standard Flexible Cable Assemblies							
See website for the following cable(s)							
53.5 Ohm, RG55B/U Coax					PE3479	7	
50 Ohm, RG58C/U Coax							
0.195" dia.	20 dB / 100 ft.	44 W	12"	PE3615-12	\$28.05	\$26.09	\$24.12
			24"	PE3615-24	\$28.60	\$26.60	\$24.60
			36"	PE3615-36	\$29.10	\$27.06	\$25.03
			48"	PE3615-48	\$29.65	\$27.57	\$25.50
			60"	PE3615-60	\$30.20	\$28.09	\$25.97
Any	PE3615-XX	See Website for Pricing					
See website for the following cable(s)							
93 Ohm, RG71B/U Coax					PE38700	9	
50 Ohm, RG142B/U Coax							
0.195" dia.	13 dB / 100 ft.	650 W	12"	PE3696-12	\$32.75	\$30.46	\$28.17
			24"	PE3696-24	\$35.55	\$33.06	\$30.57
			36"	PE3696-36	\$38.25	\$35.57	\$32.90
			48"	PE3696-48	\$41.00	\$38.13	\$35.26
			60"	PE3696-60	\$44.35	\$41.25	\$38.14
Any	PE3696-XX	See Website for Pricing					
50 Ohm, RG174A/U Coax							
0.100" dia.	31 dB / 100 ft.	16 W	12"	PE3745-12	\$33.50	\$31.16	\$28.81
			24"	PE3745-24	\$33.95	\$31.57	\$29.20
			36"	PE3745-36	\$34.40	\$31.99	\$29.58
			48"	PE3745-48	\$34.80	\$32.36	\$29.93
			60"	PE3745-60	\$35.25	\$32.78	\$30.32
Any	PE3745-XX	See Website for Pricing					
50 Ohm, RG178B/U Coax							
0.750" dia.	45 dB / 100 ft.	78 W	12"	PE33258-12	\$53.25	\$49.52	\$45.80
			24"	PE33258-24	\$54.30	\$50.50	\$46.70
			36"	PE33258-36	\$55.25	\$51.38	\$47.52
			48"	PE33258-48	\$56.20	\$52.27	\$48.33
			60"	PE33258-60	\$57.25	\$53.24	\$49.24
Any	PE33258-XX	See Website for Pricing					
50 Ohm, RG188A/U Coax							
0.110" dia.	30 dB / 100 ft.	160 W	12"	PE3885-12	\$34.75	\$32.32	\$29.89
			24"	PE3885-24	\$36.45	\$33.90	\$31.35
			36"	PE3885-36	\$38.15	\$35.48	\$32.81
			48"	PE3885-48	\$39.85	\$37.06	\$34.27
			60"	PE3885-60	\$41.55	\$38.64	\$35.73
Any	PE3885-XX	See Website for Pricing					
See website for the following cable(s)							
50 Ohm, RG196A/U Coax					PE33523	14	
50 Ohm, RG213/U Coax					PE36661	15	
50 Ohm, RG214/U Coax					PE33519	16	
50 Ohm, RG223/U Coax							
0.216" dia.	16.5 dB / 100 ft.	53 W	12"	PE3562-12	\$31.40	\$29.20	\$27.00
			24"	PE3562-24	\$32.75	\$30.46	\$28.17
			36"	PE3562-36	\$34.15	\$31.76	\$29.37
			48"	PE3562-48	\$35.55	\$33.06	\$30.57
			60"	PE3562-60	\$36.85	\$34.27	\$31.69
Any	PE3562-XX	See Website for Pricing					
50 Ohm, RG316/U Coax							
0.102" dia.	30 dB / 100 ft.	160 W	12"	PE3658-12	\$35.50	\$33.02	\$30.53
			24"	PE3658-24	\$37.85	\$35.20	\$32.55
			36"	PE3658-36	\$40.25	\$37.43	\$34.62
			48"	PE3658-48	\$42.65	\$39.66	\$36.68
			60"	PE3658-60	\$45.05	\$41.90	\$38.74
Any	PE3658-XX	See Website for Pricing					
See website for the following cable(s)							
50 Ohm, RG316-DS Coax					PE33559	19	
50 Ohm, RG393/U Coax					PE33521	20	

Cable Assemblies

*Coax Performance at 1 GHz
Notes: Cable assembly max frequency may be lower than connector or coax max frequency

Continued on Next Page

Continued from Previous Page

SMA MALE TO BNC MALE



Cable Dia.	Atten.*	Max Power*	Length	Model No.	1-24	25-49	50-99
50 Ohm, RG400/U Coax							
0.195" dia.	13 dB / 100 ft.	650 W	12"	PE3613-12	\$33.50	\$31.16	\$28.81
			24"	PE3613-24	\$38.95	\$36.22	\$33.50
			36"	PE3613-36	\$44.35	\$41.25	\$38.14
			48"	PE3613-48	\$49.80	\$46.31	\$42.83
			60"	PE3613-60	\$55.25	\$51.38	\$47.52
Any	PE3613-XX	See Website for Pricing					
75 Ohm, RG59B/U Coax							
0.242" dia.	11.5 dB / 100 ft.	77 W	12"	PE3539-12	\$38.25	\$35.57	\$32.90
			24"	PE3539-24	\$38.70	\$35.99	\$33.28
			36"	PE3539-36	\$39.10	\$36.36	\$33.63
			48"	PE3539-48	\$39.50	\$36.74	\$33.97
			60"	PE3539-60	\$39.85	\$37.06	\$34.27
Any	PE3539-XX	See Website for Pricing					
75 Ohm, RG179B/U Coax							
0.100" dia.	25 dB / 100 ft.	200 W	12"	PE3626-12	\$34.95	\$32.50	\$30.06
			24"	PE3626-24	\$36.85	\$34.27	\$31.69
			36"	PE3626-36	\$38.75	\$36.04	\$33.33
			48"	PE3626-48	\$40.60	\$37.76	\$34.92
			60"	PE3626-60	\$42.50	\$39.53	\$36.55
Any	PE3626-XX	See Website for Pricing					
See website for the following cable(s)							
50 Ohm, PE-P195 Coax				PE33989			
Standard Formable Cable Assemblies							
See website for the following cable(s)							
50 Ohm, PE-SR402FL Coax				PE34008			
50 Ohm, PE-SR405FL Coax				PE35109			

SMA MALE TO NMO MOUNT CONNECTOR

NMO MOUNT REQUIRES 3/4" HOLE, 1 1/8"-18 THREAD AND INSTALLS FROM ABOVE.



Cable	Model No.
Standard Flexible Cable Assemblies	
See website for the following cable(s)	
50 Ohm, RG58C/U Coax	PE37840

SMA MALE RIGHT ANGLE TO N FEMALE BULKHEAD

SEE MOUNTING HOLE SECTION ON PAGE 246



Cable	Model No.
Precision Formable Cable Assemblies	
Please see precision section, page 6-29	
50 Ohm, PE-SR402FL Coax	PE39456
50 Ohm, PE-SR402FLJ Jacketed Coax	PE39470
50 Ohm, PE-SR405FL Coax	PE39448
50 Ohm, PE-SR405FLJ Jacketed Coax	PE39462

The Type N connector was invented in the 1940s by Paul Neill.

SMA MALE RIGHT ANGLE TO TNC FEMALE BULKHEAD

SEE MOUNTING HOLE SECTION ON PAGE 246



Cable	Model No.
Precision Formable Cable Assemblies	
Please see precision section, page 6-29	
50 Ohm, PE-SR402FL Coax	PE39484
50 Ohm, PE-SR402FLJ Jacketed Coax	PE39498
50 Ohm, PE-SR405FL Coax	PE39476
50 Ohm, PE-SR405FLJ Jacketed Coax	PE39490

SMA MALE RIGHT ANGLE TO BNC MALE



Cable Dia.	Atten.*	Max Power*	Length	Model No.	1-24	25-49	50-99
Standard Flexible Cable Assemblies							
50 Ohm, RG142B/U Coax							
0.195" dia.	13 dB / 100 ft.	650 W	12"	PE3780-12	\$45.05	\$41.90	\$38.74
			24"	PE3780-24	\$47.75	\$44.41	\$41.07
			36"	PE3780-36	\$50.50	\$46.97	\$43.43
			48"	PE3780-48	\$53.25	\$49.52	\$45.80
			60"	PE3780-60	\$56.00	\$52.08	\$48.16
Any	PE3780-XX	See Website for Pricing					
50 Ohm, RG174A/U Coax							
0.100" dia.	31 dB / 100 ft.	16 W	12"	PE3886-12	\$42.50	\$39.53	\$36.55
			24"	PE3886-24	\$42.75	\$39.76	\$36.77
			36"	PE3886-36	\$43.00	\$39.99	\$36.98
			48"	PE3886-48	\$43.25	\$40.22	\$37.20
			60"	PE3886-60	\$43.55	\$40.50	\$37.45
Any	PE3886-XX	See Website for Pricing					
See website for the following cable(s)							
50 Ohm, RG178B/U Coax				PE33257			
50 Ohm, RG188A/U Coax							
0.110" dia.	30 dB / 100 ft.	160 W	12"	PE3756-12	\$41.60	\$38.69	\$35.78
			24"	PE3756-24	\$43.30	\$40.27	\$37.24
			36"	PE3756-36	\$45.00	\$41.85	\$38.70
			48"	PE3756-48	\$46.70	\$43.43	\$40.16
			60"	PE3756-60	\$48.35	\$44.97	\$41.58
Any	PE3756-XX	See Website for Pricing					
50 Ohm, RG223/U Coax							
0.216" dia.	16.5 dB / 100 ft.	53 W	12"	PE3733-12	\$44.45	\$41.34	\$38.23
			24"	PE3733-24	\$45.75	\$42.55	\$39.35
			36"	PE3733-36	\$47.05	\$43.76	\$40.46
			48"	PE3733-48	\$48.45	\$45.06	\$41.67
			60"	PE3733-60	\$49.90	\$46.41	\$42.91
Any	PE3733-XX	See Website for Pricing					
50 Ohm, RG316/U Coax							
0.102" dia.	30 dB / 100 ft.	160 W	12"	PE3811-12	\$42.30	\$39.34	\$36.38
			24"	PE3811-24	\$44.70	\$41.57	\$38.44
			36"	PE3811-36	\$47.10	\$43.80	\$40.51
			48"	PE3811-48	\$49.50	\$46.04	\$42.57
			60"	PE3811-60	\$51.85	\$48.22	\$44.59
Any	PE3811-XX	See Website for Pricing					
See website for the following cable(s)							
50 Ohm, RG316-DS Coax				PE33600			
50 Ohm, RG400/U Coax							
0.195" dia.	13 dB / 100 ft.	650 W	12"	PE3642-12	\$45.05	\$41.90	\$38.74
			24"	PE3642-24	\$48.15	\$44.78	\$41.41
			36"	PE3642-36	\$53.60	\$49.85	\$46.10
			48"	PE3642-48	\$59.00	\$54.87	\$50.74
			60"	PE3642-60	\$64.45	\$59.94	\$55.43
Any	PE3642-XX	See Website for Pricing					

Cable Assemblies

*Coax Performance at 1 GHz
Notes: Cable assembly max frequency may be lower than connector or coax max frequency

Continued on Next Page

ROHS & REACH COMPLIANT. CUSTOM-LENGTH CABLE ASSEMBLIES MAY BE ORDERED ON OUR WEBSITE.

Continued from Previous Page

SMA MALE RIGHT ANGLE TO BNC MALE



Cable Dia.	Atten.*	Max Power*	Length	Model No.	1-24	25-49	50-99
See website for the following cable(s)							
50 Ohm, PE-C195 Coax				PE38093			1

SMA FEMALE TO N MALE



Cable	Model No.
Precision Flexible Cable Assemblies	
Please see precision section, page 6-29	
50 Ohm, 300 Series Coax	PE306

SMA FEMALE TO QMA MALE



Cable	Model No.
Standard Flexible Cable Assemblies	
See website for the following cable(s)	
50 Ohm, RG58C/U Coax	PE38277
50 Ohm, RG316/U Coax	PE38276
50 Ohm, RG316-DS Coax	PE38052
50 Ohm, PE-C195 Coax	PE38278

SMA FEMALE TO FAKRA PLUG

SEE FAKRA SPECIFICATION ON PAGE 243



Cable	Model No.
Standard Flexible Cable Assemblies	
See website for the following cable(s)	
50 Ohm, RG174A/U Coax	PE39345A
	PE39345B
	PE39345C
	PE39345D
	PE39345H
	PE39345I
	PE39345K
50 Ohm, RG316/U Coax	PE39345Z
	PE39346A
	PE39346B
	PE39346C
	PE39346D
	PE39346H
	PE39346I
	PE39346K
	PE39346Z
	50 Ohm, PE-C100 Coax
PE39344B	
PE39344C	
PE39344D	
PE39344H	
PE39344I	
PE39344K	
PE39344Z	

SMA FEMALE TO FAKRA JACK

SEE FAKRA SPECIFICATION ON PAGE 243



Cable	Model No.
Standard Flexible Cable Assemblies	
See website for the following cable(s)	
50 Ohm, RG174A/U Coax	PE39350A
	PE39350B
	PE39350C
	PE39350D
	PE39350H
	PE39350I
	PE39350K
50 Ohm, RG316/U Coax	PE39350Z
	PE39351A
	PE39351B
	PE39351C
	PE39351D
	PE39351H
	PE39351I
50 Ohm, PE-C100 Coax	PE39351K
	PE39351Z
	PE39349A
	PE39349B
	PE39349C
	PE39349D
	PE39349H
	PE39349I
PE39349K	
PE39349Z	

SMA FEMALE TO NMO MOUNT CONNECTOR

NMO MOUNT REQUIRES 3/4" HOLE, 1 1/8"-18 THREAD AND INSTALLS FROM ABOVE.



Cable	Model No.
Standard Flexible Cable Assemblies	
See website for the following cable(s)	
50 Ohm, RG58C/U Coax	PE37841

SMA FEMALE BULKHEAD TO UMCX PLUG

SEE MOUNTING HOLE SECTION ON PAGE 246



Cable Dia.	Atten.*	Max Power*	Length	Model No.	1-24	25-49	50-99
Standard Flexible Cable Assemblies							
50 Ohm, 1.13mm Coax							
0.750" dia.	45 dB / 100 ft.	78 W	6"	PE38297-6	\$16.72	\$15.55	\$14.38
			12"	PE38297-12	\$17.38	\$16.16	\$14.95
			18"	PE38297-18	\$18.39	\$17.10	\$15.82
			Any	PE38297-XX	See Website for Pricing		

A GPS satellite circles the Earth roughly once every 12 hours.

Cable Assemblies

*Coax Performance at 1 GHz
Notes: Cable assembly max frequency may be lower than connector or coax max frequency

Continued on Next Page

Cable Assemblies

SMA FEMALE BULKHEAD TO UMCX PLUG RIGHT ANGLE

SEE MOUNTING HOLE SECTION ON PAGE 246



Cable Model No.

Standard Flexible Cable Assemblies

See website for the following cable(s)		1
50 Ohm, RG178B/U Coax	PE38299	

SMA FEMALE BULKHEAD TO MMCX PLUG

SEE MOUNTING HOLE SECTION ON PAGE 246



Cable Dia. Atten.* Max Power* Length Model No. 1-24 25-49 50-99

Precision Formable Cable Assemblies

Please see precision section, page 6-29		2
50 Ohm, PE-SR405FL Coax	PE39422	
50 Ohm, PE-SR405FLJ Jacketed Coax	PE39436	3

Standard Flexible Cable Assemblies

50 Ohm, RG316/U Coax							
0.102" dia.	30 dB / 100 ft.	160 W	12"	PE35575-12	\$43.00	\$39.99	\$36.98
			24"	PE35575-24	\$45.35	\$42.18	\$39.00
			36"	PE35575-36	\$47.75	\$44.41	\$41.07
			48"	PE35575-48	\$50.15	\$46.64	\$43.13
			60"	PE35575-60	\$52.55	\$48.87	\$45.19
			Any	PE35575-XX	See Website for Pricing		

SMA FEMALE BULKHEAD TO MMCX PLUG RIGHT ANGLE

SEE MOUNTING HOLE SECTION ON PAGE 246



Cable Dia. Atten.* Max Power* Length Model No. 1-24 25-49 50-99

Standard Flexible Cable Assemblies

50 Ohm, RG316/U Coax							
0.102" dia.	30 dB / 100 ft.	160 W	12"	PE34686-12	\$50.40	\$46.87	\$43.34
			24"	PE34686-24	\$52.80	\$49.10	\$45.41
			36"	PE34686-36	\$55.20	\$51.34	\$47.47
			48"	PE34686-48	\$57.60	\$53.57	\$49.54
			60"	PE34686-60	\$60.00	\$55.80	\$51.60
			Any	PE34686-XX	See Website for Pricing		

SMA FEMALE BULKHEAD TO 75 OHM MCX JACK

SEE MOUNTING HOLE SECTION ON PAGE 246



Cable Model No.

Precision Formable Cable Assemblies

Please see precision section, page 6-29		6
50 Ohm, PE-SR405FL Coax	PE39421	
50 Ohm, PE-SR405FLJ Jacketed Coax	PE39435	7

Japan's "Tokyo Skytree" is the world's tallest broadcasting tower at 2,080 ft tall.

REVERSE POLARITY SMA MALE TO N MALE



Cable Dia. Atten.* Max Power* Length Model No. 1-24 25-49 50-99

Standard Flexible Cable Assemblies

50 Ohm, RG58C/U Coax							
0.195" dia.	20 dB / 100 ft.	44 W	12"	PE34727-12	\$42.50	\$39.53	\$36.55
			24"	PE34727-24	\$43.00	\$39.99	\$36.98
			36"	PE34727-36	\$43.55	\$40.50	\$37.45
			48"	PE34727-48	\$44.10	\$41.01	\$37.93
			60"	PE34727-60	\$44.65	\$41.52	\$38.40
			Any	PE34727-XX	See Website for Pricing		

50 Ohm, RG142B/U Coax							
0.195" dia.	13 dB / 100 ft.	650 W	12"	PE34361-12	\$39.75	\$36.97	\$34.19
			24"	PE34361-24	\$43.90	\$40.83	\$37.75
			36"	PE34361-36	\$48.05	\$44.69	\$41.32
			48"	PE34361-48	\$52.20	\$48.55	\$44.89
			60"	PE34361-60	\$56.30	\$52.36	\$48.42
			Any	PE34361-XX	See Website for Pricing		

50 Ohm, RG174A/U Coax							
0.100" dia.	31 dB / 100 ft.	16 W	12"	PE35221-12	\$41.00	\$38.13	\$35.26
			24"	PE35221-24	\$41.25	\$38.36	\$35.48
			36"	PE35221-36	\$41.50	\$38.60	\$35.69
			48"	PE35221-48	\$41.80	\$38.87	\$35.95
			60"	PE35221-60	\$42.25	\$39.29	\$36.34
			Any	PE35221-XX	See Website for Pricing		

See website for the following cable(s)		11
50 Ohm, RG223/U Coax	PE35227	
50 Ohm, RG400/U Coax	PE34323	
50 Ohm, PE-C195 Coax	PE36072	12

REVERSE POLARITY SMA MALE TO TNC MALE



Cable Dia. Atten.* Max Power* Length Model No. 1-24 25-49 50-99

Standard Flexible Cable Assemblies

50 Ohm, RG58C/U Coax							
0.195" dia.	20 dB / 100 ft.	44 W	12"	PE35214-12	\$39.95	\$37.15	\$34.36
			24"	PE35214-24	\$40.50	\$37.67	\$34.83
			36"	PE35214-36	\$41.05	\$38.18	\$35.30
			48"	PE35214-48	\$41.55	\$38.64	\$35.73
			60"	PE35214-60	\$42.10	\$39.15	\$36.21
			Any	PE35214-XX	See Website for Pricing		

See website for the following cable(s)		14
50 Ohm, RG142B/U Coax	PE35216	

REVERSE POLARITY SMA MALE TO BNC MALE



Cable Model No.

Standard Flexible Cable Assemblies

See website for the following cable(s)		16
50 Ohm, RG58C/U Coax	PE35207	
50 Ohm, RG142B/U Coax	PE35209	
50 Ohm, RG174A/U Coax	PE35211	17

*Coax Performance at 1 GHz
Notes: Cable assembly max frequency may be lower than connector or coax max frequency

REVERSE POLARITY SMA FEMALE BULKHEAD TO UMCX PLUG RIGHT ANGLE

SEE MOUNTING HOLE SECTION ON PAGE 246



Cable	Model No.
Standard Flexible Cable Assemblies	
See website for the following cable(s)	
50 Ohm, RG178B/U Coax	PE38300

1

REVERSE THREAD SMA FEMALE BULKHEAD TO UMCX PLUG RIGHT ANGLE

SEE MOUNTING HOLE SECTION ON PAGE 246



Cable	Model No.
Standard Flexible Cable Assemblies	
See website for the following cable(s)	
50 Ohm, RG178B/U Coax	PE38301

2

3.5MM MALE TO 3.5MM MALE



Cable	Model No.
Precision Flexible Cable Assemblies	
Please see precision section, page 6-29	
50 Ohm, VNA CABLE Coax	PE315
Standard Semirigid Cable Assemblies	
See website for the following cable(s)	
50 Ohm, PE-SR402AL Coax	PE34572

3

3.5MM MALE TO 3.5MM FEMALE



Cable	Model No.
Precision Flexible Cable Assemblies	
Please see precision section, page 6-29	
50 Ohm, VNA CABLE Coax	PE317

5

2.92MM MALE TO 2.92MM MALE



Cable	Model No.
Precision Flexible Cable Assemblies	
Please see precision section, page 6-29	
50 Ohm, VNA CABLE Coax	PE319
50 Ohm, 095 Series Coax	PE35591
Standard Formable Cable Assemblies	
See website for the following cable(s)	
50 Ohm, PE-SR402FL Coax	PE34733
50 Ohm, PE-SR405FL Coax	PE34737
Standard Semirigid Cable Assemblies	
See website for the following cable(s)	
50 Ohm, RG405/U Coax	PE34735

6
7
8
9
10

2.92MM MALE TO 2.92MM FEMALE



Cable	Model No.
Precision Flexible Cable Assemblies	
Please see precision section, page 6-29	
50 Ohm, VNA CABLE Coax	PE321

11

2.92MM MALE TO 2.92MM FEMALE BULKHEAD

SEE MOUNTING HOLE SECTION ON PAGE 246



Cable	Model No.
Standard Formable Cable Assemblies	
See website for the following cable(s)	
50 Ohm, PE-SR402FL Coax	PE34745
50 Ohm, PE-SR405FL Coax	PE34749
Standard Semirigid Cable Assemblies	
See website for the following cable(s)	
50 Ohm, PE-SR402AL Coax	PE34743
50 Ohm, RG402/U Coax	PE34741
50 Ohm, RG405/U Coax	PE34747

12
13
14
15
16

2.92MM MALE TO 2.4MM MALE



Cable	Model No.
Precision Flexible Cable Assemblies	
Please see precision section, page 6-29	
50 Ohm, 095 Series Coax	PE35606
Standard Formable Cable Assemblies	
See website for the following cable(s)	
50 Ohm, PE-SR405FL Coax	PE35664
Standard Semirigid Cable Assemblies	
See website for the following cable(s)	
50 Ohm, RG405/U Coax	PE35660

17
18
19

2.92MM MALE TO 1.85MM MALE



Cable	Model No.
Precision Flexible Cable Assemblies	
Please see precision section, page 6-29	
50 Ohm, 095 Series Coax	PE36674

20

2.4MM MALE TO 2.4MM MALE



Cable	Model No.
Precision Flexible Cable Assemblies	
Please see precision section, page 6-29	
50 Ohm, 095 Series Coax	PE35611
Standard Formable Cable Assemblies	
See website for the following cable(s)	
50 Ohm, PE-SR405FL Coax	PE35652

21
22

Continued on Next Page

Continued from Previous Page

2.4MM MALE TO 2.4MM MALE



Cable Model No.

Standard Semirigid Cable Assemblies

See website for the following cable(s)

50 Ohm, RG405/U Coax	PE35639	1
----------------------	---------	---

2.4MM MALE TO 2.4MM FEMALE



Cable Model No.

Standard Formable Cable Assemblies

See website for the following cable(s)

50 Ohm, PE-SR405FL Coax	PE35658	2
-------------------------	---------	---

Standard Semirigid Cable Assemblies

See website for the following cable(s)

50 Ohm, RG405/U Coax	PE35654	3
----------------------	---------	---

2.4MM MALE TO 1.85MM MALE



Cable Model No.

Precision Flexible Cable Assemblies

See website for the following cable(s)

50 Ohm, 095 Series Coax	PE36676	4
-------------------------	---------	---

1.85MM MALE TO 1.85MM MALE



Cable Dia. Model No.

Precision Flexible Cable Assemblies

See website for the following cable(s)

50 Ohm, 095 Series Coax	PE36678	5
-------------------------	---------	---

Standard Formable Cable Assemblies

See website for the following cable(s)

50 Ohm, PE-SR047FL Coax	PE36521	6
-------------------------	---------	---

Standard Semirigid Cable Assemblies

See website for the following cable(s)

50 Ohm, PE-047SR Coax	PE36519	7
-----------------------	---------	---

SSMA MALE TO SSMA MALE



Cable Model No.

Standard Flexible Cable Assemblies

See website for the following cable(s)

50 Ohm, RG174A/U Coax	PE3673	8
50 Ohm, RG178B/U Coax	PE33762	9
50 Ohm, RG316/U Coax	PE33071	10

There are currently more than 2,500 satellites orbiting Earth.

N MALE TO N MALE



Cable Dia. Atten. * Max Power * Length Model No. 1-24 25-49 50-99

Precision Flexible Cable Assemblies

Please see precision section, page 6-29

50 Ohm, 150 Series Coax	PE33232	11
50 Ohm, 165 Non-Magnetic Series Coax	PE35028	12
50 Ohm, 300 Series Coax	PE302	13

Precision Formable Cable Assemblies

Please see precision section, page 6-29

50 Ohm, PE-SR402FL Coax	PE39451	14
50 Ohm, PE-SR402FLJ Jacketed Coax	PE39465	15
50 Ohm, PE-SR405FL Coax	PE39443	16
50 Ohm, PE-SR405FLJ Jacketed Coax	PE39457	17

Standard Flexible Cable Assemblies

52 Ohm, RG8A/U Coax

0.405" dia.	9 dB / 100 ft.	190 W	12"	PE3570-12	\$45.60	\$42.41	\$39.22
			24"	PE3570-24	\$47.80	\$44.45	\$41.11
			36"	PE3570-36	\$49.95	\$46.45	\$42.96
			48"	PE3570-48	\$52.15	\$48.50	\$44.85
			60"	PE3570-60	\$54.30	\$50.50	\$46.70
			Any	PE3570-XX	See Website for Pricing		

See website for the following cable(s)

53.5 Ohm, RG55B/U Coax	PE3499	19
------------------------	--------	----

50 Ohm, RG58C/U Coax

0.195" dia.	20 dB / 100 ft.	44 W	12"	PE3441-12	\$35.05	\$32.60	\$30.14
			24"	PE3441-24	\$35.50	\$33.02	\$30.53
			36"	PE3441-36	\$36.35	\$33.81	\$31.26
			48"	PE3441-48	\$36.85	\$34.27	\$31.69
			60"	PE3441-60	\$37.55	\$34.92	\$32.29
			Any	PE3441-XX	See Website for Pricing		

See website for the following cable(s)

50 Ohm, RG141A/U Coax	PE36589	21
-----------------------	---------	----

50 Ohm, RG142B/U Coax

0.195" dia.	13 dB / 100 ft.	650 W	12"	PE3455-12	\$36.90	\$34.32	\$31.73
			24"	PE3455-24	\$41.00	\$38.13	\$35.26
			36"	PE3455-36	\$45.15	\$41.99	\$38.83
			48"	PE3455-48	\$49.30	\$45.85	\$42.40
			60"	PE3455-60	\$53.45	\$49.71	\$45.97
			Any	PE3455-XX	See Website for Pricing		

See website for the following cable(s)

50 Ohm, RG174A/U Coax	PE36273	23
-----------------------	---------	----

50 Ohm, RG178B/U Coax PE33527

50 Ohm, RG188A/U Coax PE33525

50 Ohm, RG213/U Coax

0.405" dia.	9 dB / 100 ft.	190 W	12"	PE3496-12	\$44.70	\$41.57	\$38.44
			24"	PE3496-24	\$45.95	\$42.73	\$39.52
			36"	PE3496-36	\$47.15	\$43.85	\$40.55
			48"	PE3496-48	\$48.40	\$45.01	\$41.62
			60"	PE3496-60	\$49.65	\$46.17	\$42.70
			Any	PE3496-XX	See Website for Pricing		

50 Ohm, RG214/U Coax

0.425" dia.	9 dB / 100 ft.	190 W	12"	PE3062-12	\$48.75	\$45.34	\$41.93
			24"	PE3062-24	\$54.50	\$50.69	\$46.87
			36"	PE3062-36	\$60.25	\$56.03	\$51.82
			48"	PE3062-48	\$66.00	\$61.38	\$56.76
			60"	PE3062-60	\$71.75	\$66.73	\$61.71
			Any	PE3062-XX	See Website for Pricing		

See website for the following cable(s)

50 Ohm, RG217/U Coax	PE3997	28
----------------------	--------	----

50 Ohm, RG218/U Coax	PE33236	29
----------------------	---------	----

Cable Assemblies

*Coax Performance at 1 GHz
Notes: Cable assembly max frequency may be lower than connector or coax max frequency

Continued on Next Page

Continued from Previous Page

N MALE TO N MALE							
							
Cable Dia.	Atten.*	Max Power*	Length	Model No.	1-24	25-49	50-99
50 Ohm, RG223/U Coax							
0.216" dia.	16.5 dB / 100 ft.	53 W	12"	PE3447-12	\$34.95	\$32.50	\$30.06
			24"	PE3447-24	\$37.15	\$34.55	\$31.95
			36"	PE3447-36	\$39.35	\$36.60	\$33.84
			48"	PE3447-48	\$41.60	\$38.69	\$35.78
			60"	PE3447-60	\$43.80	\$40.73	\$37.67
			Any	PE3447-XX	See Website for Pricing		
See website for the following cable(s)							
50 Ohm, RG225/U Coax				PE33269			
50 Ohm, RG316/U Coax							
0.102" dia.	30 dB / 100 ft.	160 W	12"	PE3487-12	\$41.15	\$38.27	\$35.39
			24"	PE3487-24	\$43.55	\$40.50	\$37.45
			36"	PE3487-36	\$45.95	\$42.73	\$39.52
			48"	PE3487-48	\$48.35	\$44.97	\$41.58
			60"	PE3487-60	\$50.70	\$47.15	\$43.60
			Any	PE3487-XX	See Website for Pricing		
See website for the following cable(s)							
50 Ohm, RG316-DS Coax				PE33288			
50 Ohm, RG393/U Coax							
0.390" dia.	7.5 dB / 100 ft.	1700 W	12"	PE3607-12	\$55.05	\$51.20	\$47.34
			24"	PE3607-24	\$67.05	\$62.36	\$57.66
			36"	PE3607-36	\$79.05	\$73.52	\$67.98
			48"	PE3607-48	\$91.10	\$84.72	\$78.35
			60"	PE3607-60	\$103.10	\$95.88	\$88.67
			Any	PE3607-XX	See Website for Pricing		
50 Ohm, RG400/U Coax							
0.195" dia.	13 dB / 100 ft.	650 W	12"	PE3653-12	\$42.60	\$39.62	\$36.64
			24"	PE3653-24	\$48.00	\$44.64	\$41.28
			36"	PE3653-36	\$52.55	\$48.87	\$45.19
			48"	PE3653-48	\$56.30	\$52.36	\$48.42
			60"	PE3653-60	\$60.25	\$56.03	\$51.82
			Any	PE3653-XX	See Website for Pricing		
See website for the following cable(s)							
50 Ohm, PE-B400 Coax				PE3629			
50 Ohm, PE-B405 Coax							
0.405" dia.	4.5 dB / 100 ft.	344 W	12"	PE3279-12	\$46.45	\$43.20	\$39.95
			24"	PE3279-24	\$47.40	\$44.08	\$40.76
			36"	PE3279-36	\$48.40	\$45.01	\$41.62
			48"	PE3279-48	\$49.45	\$45.99	\$42.53
			60"	PE3279-60	\$50.85	\$47.29	\$43.73
			Any	PE3279-XX	See Website for Pricing		
50 Ohm, PE-C195 Coax							
0.195" dia.	11.5 dB / 100 ft.	150 W	36"	PE37940-36	\$34.35	\$31.95	\$29.54
			48"	PE37940-48	\$35.45	\$32.97	\$30.49
			60"	PE37940-60	\$36.60	\$34.04	\$31.48
			72"	PE37940-72	\$37.70	\$35.06	\$32.42
			120"	PE37940-120	\$42.15	\$39.20	\$36.25
			Any	PE37940-XX	See Website for Pricing		
50 Ohm, PE-C240 Coax							
0.240" dia.	8 dB / 100 ft.	250 W	36"	PE37941-36	\$38.15	\$35.48	\$32.81
			48"	PE37941-48	\$40.35	\$37.53	\$34.70
			60"	PE37941-60	\$42.70	\$39.71	\$36.72
			72"	PE37941-72	\$45.05	\$41.90	\$38.74
			120"	PE37941-120	\$54.40	\$50.59	\$46.78
			Any	PE37941-XX	See Website for Pricing		
50 Ohm, PE-C300 Coax							
0.300" dia.	6.5 dB / 100 ft.	350 W	12"	PE36634-12	\$48.35	\$44.97	\$41.58
			24"	PE36634-24	\$50.50	\$46.97	\$43.43
			36"	PE36634-36	\$52.70	\$49.01	\$45.32
			48"	PE36634-48	\$54.85	\$51.01	\$47.17
			60"	PE36634-60	\$57.05	\$53.06	\$49.06
			Any	PE36634-XX	See Website for Pricing		

N MALE TO N MALE									
									
Cable Dia.	Atten.*	Max Power*	Length	Model No.	1-24	25-49	50-99		
50 Ohm, PE-C400 Coax									
0.405" dia.	4.5 dB / 100 ft.	550 W	36"	PE37942-36	\$53.65	\$49.89	\$46.14		
			48"	PE37942-48	\$57.65	\$53.61	\$49.58		
			60"	PE37942-60	\$61.65	\$57.33	\$53.02		
			72"	PE37942-72	\$65.65	\$61.05	\$56.46		
			Any	PE37942-XX	See Website for Pricing				
			See website for the following cable(s)						
50 Ohm, PE-C500 Coax				PE35522					
50 Ohm, PE-C600 Coax									
0.590" dia.	3 dB / 100 ft.	900 W	36"	PE37943-36	\$76.70	\$71.33	\$65.96		
			48"	PE37943-48	\$81.60	\$75.89	\$70.18		
			60"	PE37943-60	\$86.50	\$80.45	\$74.39		
			72"	PE37943-72	\$91.40	\$85.00	\$78.60		
			120"	PE37943-120	\$111.00	\$103.23	\$95.46		
			Any	PE37943-XX	See Website for Pricing				
See website for the following cable(s)									
50 Ohm, PE-P195 Coax				PE33377					
Standard Formable Cable Assemblies									
See website for the following cable(s)									
50 Ohm, PE-SR401FL Coax				PE34149					
50 Ohm, PE-SR402FL Coax				PE3472					
50 Ohm, PE-SR405FL Coax				PE3963					
50 Ohm, 1/2" Helical Coax				PE37968					
Standard Semirigid Cable Assemblies									
See website for the following cable(s)									
50 Ohm, PE-047SR Coax				PE34142					
50 Ohm, PE-SR402AL Coax				PE34138					
50 Ohm, RG401/U Coax				PE3782					
50 Ohm, RG402/U Coax									
50 Ohm, RG402/U Coax				PE3827					
See website for the following cable(s)									
50 Ohm, RG405/U Coax				PE3920					

N MALE TO N MALE RIGHT ANGLE							
							
Cable Dia.	Atten.*	Max Power*	Length	Model No.	1-24	25-49	50-99
Precision Flexible Cable Assemblies							
Please see precision section, page 6-29							
50 Ohm, 300 Series Coax				PE303			
Precision Formable Cable Assemblies							
Please see precision section, page 6-29							
50 Ohm, PE-SR402FL Coax				PE39453			
50 Ohm, PE-SR402FLJ Jacketed Coax				PE39467			
50 Ohm, PE-SR405FL Coax				PE39445			
50 Ohm, PE-SR405FLJ Jacketed Coax				PE39459			
Standard Flexible Cable Assemblies							
52 Ohm, RG8A/U Coax							
0.405" dia.	9 dB / 100 ft.	190 W	12"	PE3699-12	\$61.25	\$56.96	\$52.68
			24"	PE3699-24	\$63.45	\$59.01	\$54.57
			36"	PE3699-36	\$65.60	\$61.01	\$56.42
			48"	PE3699-48	\$67.80	\$63.05	\$58.31
			60"	PE3699-60	\$69.95	\$65.05	\$60.16
			Any	PE3699-XX	See Website for Pricing		

The N connector was one of the first connectors capable of carrying microwave-frequency signals.

Cable Assemblies

*Coax Performance at 1 GHz
Notes: Cable assembly max frequency may be lower than connector or coax max frequency

Continued on Next Page

Continued from Previous Page

N MALE TO N MALE RIGHT ANGLE



Cable Dia.	Atten.*	Max Power*	Length	Model No.	1-24	25-49	50-99
50 Ohm, RG58C/U Coax							
0.195" dia.	20 dB / 100 ft.	44 W	12"	PE3143-12	\$47.75	\$44.41	\$41.07
			24"	PE3143-24	\$48.25	\$44.87	\$41.50
			36"	PE3143-36	\$48.65	\$45.24	\$41.84
			48"	PE3143-48	\$49.10	\$45.66	\$42.23
			60"	PE3143-60	\$49.50	\$46.04	\$42.57
Any	PE3143-XX	See Website for Pricing					
50 Ohm, RG142B/U Coax							
0.195" dia.	13 dB / 100 ft.	650 W	12"	PE3726-12	\$47.75	\$44.41	\$41.07
			24"	PE3726-24	\$51.65	\$48.03	\$44.42
			36"	PE3726-36	\$55.80	\$51.89	\$47.99
			48"	PE3726-48	\$59.95	\$55.75	\$51.56
			60"	PE3726-60	\$64.10	\$59.61	\$55.13
Any	PE3726-XX	See Website for Pricing					
50 Ohm, RG213/U Coax							
0.405" dia.	9 dB / 100 ft.	190 W	12"	PE3797-12	\$60.35	\$56.13	\$51.90
			24"	PE3797-24	\$61.60	\$57.29	\$52.98
			36"	PE3797-36	\$62.80	\$58.40	\$54.01
			48"	PE3797-48	\$64.05	\$59.57	\$55.08
			60"	PE3797-60	\$65.30	\$60.73	\$56.16
Any	PE3797-XX	See Website for Pricing					
50 Ohm, RG214/U Coax							
0.425" dia.	9 dB / 100 ft.	190 W	12"	PE3071-12	\$67.50	\$62.78	\$58.05
			24"	PE3071-24	\$73.25	\$68.12	\$63.00
			36"	PE3071-36	\$79.00	\$73.47	\$67.94
			48"	PE3071-48	\$84.75	\$78.82	\$72.89
			60"	PE3071-60	\$90.50	\$84.17	\$77.83
Any	PE3071-XX	See Website for Pricing					
50 Ohm, RG223/U Coax							
0.216" dia.	16.5 dB / 100 ft.	53 W	12"	PE3168-12	\$47.75	\$44.41	\$41.07
			24"	PE3168-24	\$49.15	\$45.71	\$42.27
			36"	PE3168-36	\$50.50	\$46.97	\$43.43
			48"	PE3168-48	\$52.25	\$48.59	\$44.94
			60"	PE3168-60	\$54.45	\$50.64	\$46.83
Any	PE3168-XX	See Website for Pricing					
See website for the following cable(s)							
50 Ohm, RG225/U Coax				PE34203			
50 Ohm, RG316-DS Coax				PE34207			
50 Ohm, RG393/U Coax				PE3255			
50 Ohm, RG400/U Coax							
0.195" dia.	13 dB / 100 ft.	650 W	12"	PE33321-12	\$53.25	\$49.52	\$45.80
			24"	PE33321-24	\$58.65	\$54.54	\$50.44
			36"	PE33321-36	\$64.10	\$59.61	\$55.13
			48"	PE33321-48	\$69.50	\$64.64	\$59.77
			60"	PE33321-60	\$74.95	\$69.70	\$64.46
Any	PE33321-XX	See Website for Pricing					
See website for the following cable(s)							
50 Ohm, PE-B405 Coax				PE3962			
50 Ohm, PE-C195 Coax				PE37944			
50 Ohm, PE-C240 Coax				PE37945			
50 Ohm, PE-C400 Coax							
0.405" dia.	4.5 dB / 100 ft.	550 W	36"	PE37946-36	\$69.40	\$64.54	\$59.68
			48"	PE37946-48	\$73.40	\$68.26	\$63.12
			60"	PE37946-60	\$77.40	\$71.98	\$66.56
			72"	PE37946-72	\$81.40	\$75.70	\$70.00
			120"	PE37946-120	\$93.80	\$87.23	\$80.67
Any	PE37946-XX	See Website for Pricing					

N MALE TO N MALE RIGHT ANGLE



Cable Dia.	Atten.*	Max Power*	Length	Model No.	1-24	25-49	50-99
50 Ohm, PE-C600 Coax							
0.590" dia.	3 dB / 100 ft.	900 W	36"	PE37947-36	\$84.80	\$78.86	\$72.93
			48"	PE37947-48	\$88.00	\$81.84	\$75.68
			60"	PE37947-60	\$91.20	\$84.82	\$78.43
			72"	PE37947-72	\$94.35	\$87.75	\$81.14
			120"	PE37947-120	\$107.10	\$99.60	\$92.11
Any	PE37947-XX	See Website for Pricing					
Standard Formable Cable Assemblies							
See website for the following cable(s)							
50 Ohm, 1/2" Helical Coax				PE37970			

N MALE TO N FEMALE



Cable	Model No.
Precision Formable Cable Assemblies	
Please see precision section, page 6-29	
50 Ohm, PE-SR402FL Coax	PE39454
50 Ohm, PE-SR402FLJ Jacketed Coax	PE39468
50 Ohm, PE-SR405FL Coax	PE39446
50 Ohm, PE-SR405FLJ Jacketed Coax	PE39460
Standard Flexible Cable Assemblies	
See website for the following cable(s)	
50 Ohm, RG58C/U Coax	PE3714
50 Ohm, RG142B/U Coax	PE3996
50 Ohm, RG213/U Coax	PE3232
50 Ohm, RG214/U Coax	PE3650
50 Ohm, RG223/U Coax	PE3667
50 Ohm, RG316-DS Coax	PE34281
50 Ohm, RG393/U Coax	PE3977
50 Ohm, RG400/U Coax	PE3617
50 Ohm, PE-C195 Coax	PE37948
50 Ohm, PE-C240 Coax	PE37949
50 Ohm, PE-C400 Coax	PE37950
50 Ohm, PE-C600 Coax	PE37951
Standard Formable Cable Assemblies	
See website for the following cable(s)	
50 Ohm, PE-SR402FL Coax	PE3485
50 Ohm, 1/2" Helical Coax	PE37969
Standard Semirigid Cable Assemblies	
See website for the following cable(s)	
50 Ohm, PE-047SR Coax	PE34287
50 Ohm, PE-SR402AL Coax	PE34289
50 Ohm, RG401/U Coax	PE37979

N MALE TO N FEMALE BULKHEAD

SEE MOUNTING HOLE SECTION ON PAGE 246



Cable Dia.	Atten.*	Max Power*	Length	Model No.	1-24	25-49	50-99
Precision Flexible Cable Assemblies							
Please see precision section, page 6-29							
50 Ohm, 150 Series Coax				PE35952			
50 Ohm, 165 Non-Magnetic Series Coax				PE35956			
Standard Flexible Cable Assemblies							
See website for the following cable(s)							
52 Ohm, RG8AU Coax				PE3966			

Cable Assemblies

*Coax Performance at 1 GHz
Notes: Cable assembly max frequency may be lower than connector or coax max frequency

Continued on Next Page

Continued from Previous Page

N MALE TO N FEMALE BULKHEAD

SEE MOUNTING HOLE SECTION ON PAGE 246



Cable Dia.	Atten.*	Max Power*	Length	Model No.	1-24	25-49	50-99
------------	---------	------------	--------	-----------	------	-------	-------

50 Ohm, RG58C/U Coax							
0.195" dia.	20 dB / 100 ft.	44 W	12"	PE3320-12	\$46.45	\$43.20	\$39.95
			24"	PE3320-24	\$46.80	\$43.52	\$40.25
			36"	PE3320-36	\$47.25	\$43.94	\$40.64
			48"	PE3320-48	\$47.65	\$44.31	\$40.98
			60"	PE3320-60	\$48.15	\$44.78	\$41.41
			Any	PE3320-XX	See Website for Pricing		

50 Ohm, RG142B/U Coax							
0.195" dia.	13 dB / 100 ft.	650 W	12"	PE3034-12	\$46.45	\$43.20	\$39.95
			24"	PE3034-24	\$49.15	\$45.71	\$42.27
			36"	PE3034-36	\$51.90	\$48.27	\$44.63
			48"	PE3034-48	\$54.60	\$50.78	\$46.96
			60"	PE3034-60	\$57.35	\$53.34	\$49.32
			Any	PE3034-XX	See Website for Pricing		

See website for the following cable(s)

50 Ohm, RG178B/U Coax	PE34201
50 Ohm, RG213/U Coax	PE33543

50 Ohm, RG214/U Coax							
0.425" dia.	9 dB / 100 ft.	190 W	12"	PE3217-12	\$59.00	\$54.87	\$50.74
			24"	PE3217-24	\$64.75	\$60.22	\$55.69
			36"	PE3217-36	\$70.50	\$65.57	\$60.63
			48"	PE3217-48	\$76.25	\$70.91	\$65.58
			60"	PE3217-60	\$82.00	\$76.26	\$70.52
			Any	PE3217-XX	See Website for Pricing		

See website for the following cable(s)

50 Ohm, RG223/U Coax	PE3686
50 Ohm, RG316/U Coax	PE33534
50 Ohm, RG316-DS Coax	PE34198

50 Ohm, RG400/U Coax							
0.195" dia.	13 dB / 100 ft.	650 W	12"	PE3227-12	\$46.45	\$43.20	\$39.95
			24"	PE3227-24	\$50.95	\$47.38	\$43.82
			36"	PE3227-36	\$56.40	\$52.45	\$48.50
			48"	PE3227-48	\$61.80	\$57.47	\$53.15
			60"	PE3227-60	\$67.25	\$62.54	\$57.84
			Any	PE3227-XX	See Website for Pricing		

See website for the following cable(s)

50 Ohm, PE-B405 Coax	PE34196
50 Ohm, PE-C240 Coax	PE38672

Standard Formable Cable Assemblies

See website for the following cable(s)

50 Ohm, PE-SR401FL Coax	PE34150
-------------------------	---------

50 Ohm, PE-SR402FL Coax							
0.141" dia.	12 dB / 100 ft.	450 W	12"	PE3488-12	\$87.90	\$81.75	\$75.59
			24"	PE3488-24	\$91.60	\$85.19	\$78.78
			36"	PE3488-36	\$95.35	\$88.68	\$82.00
			48"	PE3488-48	\$99.10	\$92.16	\$85.23
			60"	PE3488-60	\$102.75	\$95.56	\$88.37
			Any	PE3488-XX	See Website for Pricing		

Standard Semirigid Cable Assemblies

See website for the following cable(s)

50 Ohm, RG402/U Coax	PE3830
----------------------	--------

N MALE RIGHT ANGLE TO N MALE RIGHT ANGLE



Cable Dia.	Atten.*	Max Power*	Length	Model No.	1-24	25-49	50-99
------------	---------	------------	--------	-----------	------	-------	-------

Precision Formable Cable Assemblies

50 Ohm, PE-SR402FL Coax	PE39452
-------------------------	---------

N MALE RIGHT ANGLE TO N MALE RIGHT ANGLE



Cable Dia.	Atten.*	Max Power*	Length	Model No.	1-24	25-49	50-99
------------	---------	------------	--------	-----------	------	-------	-------

Standard Flexible Cable Assemblies							
50 Ohm, PE-SR402FLJ Jacketed Coax	PE39466	16					
50 Ohm, PE-SR405FL Coax	PE39444	17					
50 Ohm, PE-SR405FLJ Jacketed Coax	PE39458	18					

52 Ohm, RG8A/U Coax							
0.405" dia.	9 dB / 100 ft.	190 W	12"	PE33974-12	\$76.90	\$71.52	\$66.13
			24"	PE33974-24	\$79.10	\$73.56	\$68.03
			36"	PE33974-36	\$81.25	\$75.56	\$69.88
			48"	PE33974-48	\$83.45	\$77.61	\$71.77
			60"	PE33974-60	\$85.60	\$79.61	\$73.62
			Any	PE33974-XX	See Website for Pricing		

See website for the following cable(s)

50 Ohm, RG58C/U Coax	PE3698	20
50 Ohm, RG142B/U Coax	PE3693	21
50 Ohm, RG174A/U Coax	PE34231	22
50 Ohm, RG213/U Coax	PE3272	23

50 Ohm, RG214/U Coax							
0.425" dia.	9 dB / 100 ft.	190 W	12"	PE3781-12	\$86.20	\$80.17	\$74.13
			24"	PE3781-24	\$91.95	\$85.51	\$79.08
			36"	PE3781-36	\$97.70	\$90.86	\$84.02
			48"	PE3781-48	\$103.45	\$96.21	\$88.97
			60"	PE3781-60	\$109.20	\$101.56	\$93.91
			Any	PE3781-XX	See Website for Pricing		

See website for the following cable(s)

50 Ohm, RG223/U Coax	PE3882	25
50 Ohm, RG316/U Coax	PE34236	26
50 Ohm, RG393/U Coax	PE3268	27
50 Ohm, RG400/U Coax	PE3412	28
50 Ohm, PE-B405 Coax	PE33168	29
50 Ohm, PE-C195 Coax	PE36910	30
50 Ohm, PE-C240 Coax	PE38699	31

Standard Formable Cable Assemblies

See website for the following cable(s)

50 Ohm, PE-SR401FL Coax	PE34680	32
50 Ohm, PE-SR402FL Coax	PE33977	33

N MALE RIGHT ANGLE TO N FEMALE BULKHEAD

SEE MOUNTING HOLE SECTION ON PAGE 246



Cable Dia.	Atten.*	Max Power*	Length	Model No.	1-24	25-49	50-99
------------	---------	------------	--------	-----------	------	-------	-------

Standard Flexible Cable Assemblies

50 Ohm, RG58C/U Coax	PE3407	34
----------------------	--------	----

50 Ohm, RG142B/U Coax							
0.195" dia.	13 dB / 100 ft.	650 W	12"	PE33021-12	\$54.60	\$50.78	\$46.96
			24"	PE33021-24	\$57.35	\$53.34	\$49.32
			36"	PE33021-36	\$60.10	\$55.89	\$51.69
			48"	PE33021-48	\$62.90	\$58.50	\$54.09
			60"	PE33021-60	\$67.05	\$62.36	\$57.66
			Any	PE33021-XX	See Website for Pricing		

See website for the following cable(s)

50 Ohm, RG188A/U Coax	PE34218	36
50 Ohm, RG213/U Coax	PE33545	37
50 Ohm, RG214/U Coax	PE33178	38
50 Ohm, RG316-DS Coax	PE34227	39
50 Ohm, RG393/U Coax	PE33532	40
50 Ohm, RG400/U Coax	PE33528	41

Cable Assemblies

*Coax Performance at 1 GHz
Notes: Cable assembly max frequency may be lower than connector or coax max frequency

Continued on Next Page

Continued from Previous Page

N MALE RIGHT ANGLE TO N FEMALE BULKHEAD

SEE MOUNTING HOLE SECTION ON PAGE 246



Cable Dia.	Atten.*	Max Power*	Length	Model No.	1-24	25-49	50-99
Standard Formable Cable Assemblies							
See website for the following cable(s)							
50 Ohm, PE-SR401FL Coax				PE39082			1

N MALE TO TNC MALE



Cable Dia.	Atten.*	Max Power*	Length	Model No.	1-24	25-49	50-99
Standard Flexible Cable Assemblies							
See website for the following cable(s)							
52 Ohm, RG8A/U Coax				PE33615			2

50 Ohm, RG58C/U Coax							
Cable Dia.	Atten.*	Max Power*	Length	Model No.	1-24	25-49	50-99
0.195" dia.	20 dB / 100 ft.	44 W	12"	PE3661-12	\$33.55	\$31.20	\$28.85
			24"	PE3661-24	\$34.10	\$31.71	\$29.33
			36"	PE3661-36	\$34.65	\$32.22	\$29.80
			48"	PE3661-48	\$35.15	\$32.69	\$30.23
			60"	PE3661-60	\$35.70	\$33.20	\$30.70
			Any	PE3661-XX	See Website for Pricing		

50 Ohm, RG142B/U Coax							
Cable Dia.	Atten.*	Max Power*	Length	Model No.	1-24	25-49	50-99
0.195" dia.	13 dB / 100 ft.	650 W	12"	PE3652-12	\$35.10	\$32.64	\$30.19
			24"	PE3652-24	\$39.25	\$36.50	\$33.76
			36"	PE3652-36	\$43.40	\$40.36	\$37.32
			48"	PE3652-48	\$47.50	\$44.18	\$40.85
			60"	PE3652-60	\$51.65	\$48.03	\$44.42
Any	PE3652-XX	See Website for Pricing				4	

See website for the following cable(s)

50 Ohm, RG174A/U Coax				PE34272			5
-----------------------	--	--	--	---------	--	--	---

50 Ohm, RG213/U Coax							
Cable Dia.	Atten.*	Max Power*	Length	Model No.	1-24	25-49	50-99
0.405" dia.	9 dB / 100 ft.	190 W	12"	PE3644-12	\$46.60	\$43.34	\$40.08
			24"	PE3644-24	\$47.85	\$44.50	\$41.15
			36"	PE3644-36	\$49.10	\$45.66	\$42.23
			48"	PE3644-48	\$50.30	\$46.78	\$43.26
			60"	PE3644-60	\$51.55	\$47.94	\$44.33
Any	PE3644-XX	See Website for Pricing				6	

See website for the following cable(s)

50 Ohm, RG214/U Coax				PE3991			7
----------------------	--	--	--	--------	--	--	---

50 Ohm, RG223/U Coax							
Cable Dia.	Atten.*	Max Power*	Length	Model No.	1-24	25-49	50-99
0.216" dia.	16.5 dB / 100 ft.	53 W	12"	PE3665-12	\$33.15	\$30.83	\$28.51
			24"	PE3665-24	\$35.40	\$32.92	\$30.44
			36"	PE3665-36	\$37.60	\$34.97	\$32.34
			48"	PE3665-48	\$39.80	\$37.01	\$34.23
			60"	PE3665-60	\$42.00	\$39.06	\$36.12
Any	PE3665-XX	See Website for Pricing				8	

See website for the following cable(s)

50 Ohm, RG316/U Coax				PE3989			9
----------------------	--	--	--	--------	--	--	---

50 Ohm, RG393/U Coax							
Cable Dia.	Atten.*	Max Power*	Length	Model No.	1-24	25-49	50-99
0.390" dia.	7.5 dB / 100 ft.	1700 W	12"	PE3982-12	\$62.95	\$58.54	\$54.14
			24"	PE3982-24	\$74.95	\$69.70	\$64.46
			36"	PE3982-36	\$87.00	\$80.91	\$74.82
			48"	PE3982-48	\$99.00	\$92.07	\$85.14
			60"	PE3982-60	\$111.05	\$103.28	\$95.50
Any	PE3982-XX	See Website for Pricing				10	

50 Ohm, RG400/U Coax							
Cable Dia.	Atten.*	Max Power*	Length	Model No.	1-24	25-49	50-99
0.195" dia.	13 dB / 100 ft.	650 W	12"	PE3666-12	\$40.80	\$37.94	\$35.09
			24"	PE3666-24	\$46.25	\$43.01	\$39.78
			36"	PE3666-36	\$50.60	\$47.06	\$43.52
			48"	PE3666-48	\$54.50	\$50.69	\$46.87
			60"	PE3666-60	\$58.35	\$54.27	\$50.18
Any	PE3666-XX	See Website for Pricing				11	

N MALE TO TNC MALE



Cable Dia.	Atten.*	Max Power*	Length	Model No.	1-24	25-49	50-99
See website for the following cable(s)							
50 Ohm, PE-C195 Coax				PE35785			12
50 Ohm, PE-C240 Coax				PE36958			13
50 Ohm, PE-C300 Coax				PE37980			14
50 Ohm, PE-C400 Coax				PE34801			15

N MALE TO REVERSE POLARITY TNC MALE



Cable Dia.	Atten.*	Max Power*	Length	Model No.	1-24	25-49	50-99
Standard Flexible Cable Assemblies							
50 Ohm, RG58C/U Coax							
0.195" dia.	20 dB / 100 ft.	44 W	12"	PE34554-12	\$34.85	\$32.41	\$29.97
			24"	PE34554-24	\$35.40	\$32.92	\$30.44
			36"	PE34554-36	\$35.90	\$33.39	\$30.87
			48"	PE34554-48	\$36.45	\$33.90	\$31.35
			60"	PE34554-60	\$37.00	\$34.41	\$31.82
			Any	PE34554-XX	See Website for Pricing		

See website for the following cable(s)

50 Ohm, RG142B/U Coax				PE34573			17
-----------------------	--	--	--	---------	--	--	----

50 Ohm, RG223/U Coax							
Cable Dia.	Atten.*	Max Power*	Length	Model No.	1-24	25-49	50-99
0.216" dia.	16.5 dB / 100 ft.	53 W	12"	PE35245-12	\$33.55	\$31.20	\$28.85
			24"	PE35245-24	\$35.50	\$33.02	\$30.53
			36"	PE35245-36	\$37.70	\$35.06	\$32.42
			48"	PE35245-48	\$39.90	\$37.11	\$34.31
			60"	PE35245-60	\$42.10	\$39.15	\$36.21
Any	PE35245-XX	See Website for Pricing				18	

See website for the following cable(s)

50 Ohm, RG316/U Coax				PE35247			19
50 Ohm, RG400/U Coax				PE34626			20

50 Ohm, PE-B405 Coax							
Cable Dia.	Atten.*	Max Power*	Length	Model No.	1-24	25-49	50-99
0.405" dia.	4.5 dB / 100 ft.	344 W	12"	PE35249-12	\$49.55	\$46.08	\$42.61
			24"	PE35249-24	\$51.60	\$47.99	\$44.38
			36"	PE35249-36	\$53.65	\$49.89	\$46.14
			48"	PE35249-48	\$55.70	\$51.80	\$47.90
			60"	PE35249-60	\$57.70	\$53.66	\$49.62
Any	PE35249-XX	See Website for Pricing				21	

N MALE TO 7/16 DIN MALE



Cable Dia.	Atten.*	Max Power*	Length	Model No.	1-24	25-49	50-99
Standard Flexible Cable Assemblies							
52 Ohm, RG8A/U Coax							
0.405" dia.	9 dB / 100 ft.	190 W	12"	PE35284-12	\$50.35	\$46.83	\$43.30
			24"	PE35284-24	\$51.10	\$47.52	\$43.95
			36"	PE35284-36	\$51.85	\$48.22	\$44.59
			48"	PE35284-48	\$52.60	\$48.92	\$45.24
			60"	PE35284-60	\$53.40	\$49.66	\$45.92
Any	PE35284-XX	See Website for Pricing				22	

See website for the following cable(s)

50 Ohm, RG58C/U Coax				PE3207			23
----------------------	--	--	--	--------	--	--	----

Cable Assemblies

*Coax Performance at 1 GHz
Notes: Cable assembly max frequency may be lower than connector or coax max frequency

Continued on Next Page

Continued from Previous Page

N MALE TO 7/16 DIN MALE							
							
Cable Dia.	Atten.*	Max Power*	Length	Model No.	1-24	25-49	50-99
50 Ohm, RG214/U Coax							
0.425" dia.	9 dB / 100 ft.	190 W	12"	PE3218-12	\$122.40	\$113.83	\$105.26
			24"	PE3218-24	\$128.15	\$119.18	\$110.21
			36"	PE3218-36	\$133.90	\$124.53	\$115.15
			48"	PE3218-48	\$139.65	\$129.87	\$120.10
			60"	PE3218-60	\$145.40	\$135.22	\$125.04
Any	PE3218-XX	See Website for Pricing					
See website for the following cable(s)							
50 Ohm, RG217/U Coax			PE36170				
50 Ohm, RG393/U Coax			PE34357				
50 Ohm, RG400/U Coax			PE34359				
50 Ohm, PE-C600 Coax			PE38436				

N MALE TO MINI UHF MALE							
							
Cable Dia.	Atten.*	Max Power*	Length	Model No.	1-24	25-49	50-99
Standard Flexible Cable Assemblies							
See website for the following cable(s)							
50 Ohm, RG58C/U Coax			PE3282				
50 Ohm, RG142B/U Coax							
0.195" dia.	13 dB / 100 ft.	650 W	12"	PE3285-12	\$29.90	\$27.81	\$25.71
			24"	PE3285-24	\$34.00	\$31.62	\$29.24
			36"	PE3285-36	\$38.15	\$35.48	\$32.81
			48"	PE3285-48	\$42.30	\$39.34	\$36.38
			60"	PE3285-60	\$46.45	\$43.20	\$39.95
Any	PE3285-XX	See Website for Pricing					
See website for the following cable(s)							
50 Ohm, RG223/U Coax			PE3280				
50 Ohm, RG400/U Coax			PE3288				

N MALE TO QN MALE							
							
Cable	Model No.						
Standard Flexible Cable Assemblies							
See website for the following cable(s)							
50 Ohm, RG58C/U Coax			PE38452				
50 Ohm, RG213/U Coax			PE38450				
50 Ohm, RG223/U Coax			PE38451				
50 Ohm, PE-C195 Coax			PE38453				

N MALE TO QN MALE RIGHT ANGLE							
							
Cable	Model No.						
Standard Flexible Cable Assemblies							
See website for the following cable(s)							
50 Ohm, RG58C/U Coax			PE38489				
50 Ohm, RG213/U Coax			PE38491				
50 Ohm, RG223/U Coax			PE38492				
50 Ohm, PE-C195 Coax			PE38490				

N MALE TO UMCX PLUG RIGHT ANGLE							
							
Cable	Model No.						
Standard Flexible Cable Assemblies							
See website for the following cable(s)							
50 Ohm, RG178B/U Coax			PE38813				

N MALE TO BNC MALE							
							
Cable Dia.	Atten.*	Max Power*	Length	Model No.	1-24	25-49	50-99
Standard Flexible Cable Assemblies							
See website for the following cable(s)							
52 Ohm, RG8A/U Coax			PE3252				
53.5 Ohm, RG55B/U Coax			PE3477				
50 Ohm, RG58C/U Coax							
0.195" dia.	20 dB / 100 ft.	44 W	12"	PE3042-12	\$30.25	\$28.13	\$26.02
			24"	PE3042-24	\$30.80	\$28.64	\$26.49
			36"	PE3042-36	\$31.35	\$29.16	\$26.96
			48"	PE3042-48	\$31.90	\$29.67	\$27.43
			60"	PE3042-60	\$32.45	\$30.18	\$27.91
Any	PE3042-XX	See Website for Pricing					
50 Ohm, RG142B/U Coax							
0.195" dia.	13 dB / 100 ft.	650 W	12"	PE3061-12	\$29.90	\$27.81	\$25.71
			24"	PE3061-24	\$34.05	\$31.67	\$29.28
			36"	PE3061-36	\$38.15	\$35.48	\$32.81
			48"	PE3061-48	\$42.30	\$39.34	\$36.38
			60"	PE3061-60	\$46.45	\$43.20	\$39.95
Any	PE3061-XX	See Website for Pricing					
See website for the following cable(s)							
50 Ohm, RG174A/U Coax			PE3246				
50 Ohm, RG188A/U Coax			PE3248				
50 Ohm, RG213/U Coax			PE3750				

N MALE TO QN MALE RIGHT ANGLE							
							
Cable Dia.	Atten.*	Max Power*	Length	Model No.	1-24	25-49	50-99
Standard Flexible Cable Assemblies							
See website for the following cable(s)							
52 Ohm, RG8A/U Coax			PE3252				
53.5 Ohm, RG55B/U Coax			PE3477				
50 Ohm, RG58C/U Coax							
0.195" dia.	20 dB / 100 ft.	44 W	12"	PE3042-12	\$30.25	\$28.13	\$26.02
			24"	PE3042-24	\$30.80	\$28.64	\$26.49
			36"	PE3042-36	\$31.35	\$29.16	\$26.96
			48"	PE3042-48	\$31.90	\$29.67	\$27.43
			60"	PE3042-60	\$32.45	\$30.18	\$27.91
Any	PE3042-XX	See Website for Pricing					
50 Ohm, RG142B/U Coax							
0.195" dia.	13 dB / 100 ft.	650 W	12"	PE3061-12	\$29.90	\$27.81	\$25.71
			24"	PE3061-24	\$34.05	\$31.67	\$29.28
			36"	PE3061-36	\$38.15	\$35.48	\$32.81
			48"	PE3061-48	\$42.30	\$39.34	\$36.38
			60"	PE3061-60	\$46.45	\$43.20	\$39.95
Any	PE3061-XX	See Website for Pricing					
See website for the following cable(s)							
50 Ohm, RG174A/U Coax			PE3246				
50 Ohm, RG188A/U Coax			PE3248				
50 Ohm, RG213/U Coax			PE3750				

N MALE TO QN MALE							
							
Cable	Model No.						
Standard Flexible Cable Assemblies							
See website for the following cable(s)							
50 Ohm, RG58C/U Coax			PE38452				
50 Ohm, RG213/U Coax			PE38450				
50 Ohm, RG223/U Coax			PE38451				
50 Ohm, PE-C195 Coax			PE38453				

N MALE TO QN MALE RIGHT ANGLE							
							
Cable	Model No.						
Standard Flexible Cable Assemblies							
See website for the following cable(s)							
50 Ohm, RG58C/U Coax			PE38452				
50 Ohm, RG213/U Coax			PE38450				
50 Ohm, RG223/U Coax			PE38451				
50 Ohm, PE-C195 Coax			PE38453				

N MALE TO QN MALE RIGHT ANGLE							
							
Cable	Model No.						
Standard Flexible Cable Assemblies							
See website for the following cable(s)							
50 Ohm, RG58C/U Coax			PE38489				
50 Ohm, RG213/U Coax			PE38491				
50 Ohm, RG223/U Coax			PE38492				
50 Ohm, PE-C195 Coax			PE38490				

Cable Assemblies

*Coax Performance at 1 GHz
Notes: Cable assembly max frequency may be lower than connector or coax max frequency

Continued on Next Page

Continued from Previous Page

N MALE TO BNC MALE



Cable Dia.	Atten.*	Max Power*	Length	Model No.	1-24	25-49	50-99
50 Ohm, RG400/U Coax							
0.195" dia.	13 dB / 100 ft.	650 W	12"	PE3874-12	\$35.60	\$33.11	\$30.62
			24"	PE3874-24	\$41.00	\$38.13	\$35.26
			36"	PE3874-36	\$46.45	\$43.20	\$39.95
			48"	PE3874-48	\$51.90	\$48.27	\$44.63
			60"	PE3874-60	\$56.30	\$52.36	\$48.42
		Any	PE3874-XX	See Website for Pricing			

See website for the following cable(s)

50 Ohm, PE-B405 Coax	PE3256
50 Ohm, PE-C195 Coax	PE36065
50 Ohm, PE-C240 Coax	PE35269

N MALE TO NMO MOUNT CONNECTOR

NMO MOUNT REQUIRES 3/4" HOLE, 1 1/8"-18 THREAD AND INSTALLS FROM ABOVE.



Cable Model No.

Standard Flexible Cable Assemblies

See website for the following cable(s)

50 Ohm, RG58C/U Coax	PE37850
----------------------	---------

N FEMALE TO QN MALE



Cable Model No.

Standard Flexible Cable Assemblies

See website for the following cable(s)

50 Ohm, RG223/U Coax	PE38455
----------------------	---------

N FEMALE TO QN MALE RIGHT ANGLE



Cable Model No.

Standard Flexible Cable Assemblies

See website for the following cable(s)

50 Ohm, RG223/U Coax	PE38496
50 Ohm, PE-C195 Coax	PE38494

N FEMALE TO NMO MOUNT CONNECTOR

NMO MOUNT REQUIRES 3/4" HOLE, 1 1/8"-18 THREAD AND INSTALLS FROM ABOVE.



Cable Model No.

Standard Flexible Cable Assemblies

See website for the following cable(s)

50 Ohm, RG58C/U Coax	PE37851
----------------------	---------

N FEMALE BULKHEAD TO MMCX PLUG

SEE MOUNTING HOLE SECTION ON PAGE 246



Cable Model No.

Precision Formable Cable Assemblies

Please see precision section, page 6-29

50 Ohm, PE-SR405FL Coax	PE39450	10
50 Ohm, PE-SR405FLJ Jacketed Coax	PE39464	11

N FEMALE BULKHEAD TO 75 OHM MCX JACK

SEE MOUNTING HOLE SECTION ON PAGE 246



Cable Model No.

Precision Formable Cable Assemblies

Please see precision section, page 6-29

50 Ohm, PE-SR405FL Coax	PE39449	12
50 Ohm, PE-SR405FLJ Jacketed Coax	PE39463	13

TNC MALE TO TNC MALE



Cable Dia.	Atten.*	Max Power*	Length	Model No.	1-24	25-49	50-99
------------	---------	------------	--------	-----------	------	-------	-------

Precision Flexible Cable Assemblies

Please see precision section, page 6-29

50 Ohm, 150 Series Coax	PE35423	14
-------------------------	---------	----

Precision Formable Cable Assemblies

Please see precision section, page 6-29

50 Ohm, PE-SR402FL Coax	PE39479	15
50 Ohm, PE-SR402FLJ Jacketed Coax	PE39493	16
50 Ohm, PE-SR405FL Coax	PE39471	17
50 Ohm, PE-SR405FLJ Jacketed Coax	PE39485	18

Standard Flexible Cable Assemblies

See website for the following cable(s)

52 Ohm, RG8A/U Coax	PE3418	19
50 Ohm, RG8X Coax	PE35671	20
53.5 Ohm, RG55B/U Coax	PE3504	21

50 Ohm, RG58C/U Coax

0.195" dia.	20 dB / 100 ft.	44 W	12"	PE3394-12	\$31.00	\$28.83	\$26.66
			24"	PE3394-24	\$31.55	\$29.34	\$27.13
			36"	PE3394-36	\$32.10	\$29.85	\$27.61
			48"	PE3394-48	\$32.65	\$30.36	\$28.08
			60"	PE3394-60	\$33.20	\$30.88	\$28.55
			Any	PE3394-XX	See Website for Pricing		

50 Ohm, RG142B/U Coax

0.195" dia.	13 dB / 100 ft.	650 W	12"	PE3544-12	\$33.30	\$30.97	\$28.64
			24"	PE3544-24	\$37.45	\$34.83	\$32.21
			36"	PE3544-36	\$41.60	\$38.69	\$35.78
			48"	PE3544-48	\$45.75	\$42.55	\$39.35
			60"	PE3544-60	\$49.90	\$46.41	\$42.91
			Any	PE3544-XX	See Website for Pricing		

See website for the following cable(s)

50 Ohm, RG174A/U Coax	PE3425	24
50 Ohm, RG188A/U Coax	PE3434	25
50 Ohm, RG213/U Coax	PE3421	26

Cable Assemblies

*Coax Performance at 1 GHz
Notes: Cable assembly max frequency may be lower than connector or coax max frequency

Continued on Next Page

ROHS & REACH COMPLIANT. CUSTOM-LENGTH CABLE ASSEMBLIES MAY BE ORDERED ON OUR WEBSITE.

Continued from Previous Page

TNC MALE TO TNC MALE



Cable Dia.	Atten.*	Max Power*	Length	Model No.	1-24	25-49	50-99
50 Ohm, RG214/U Coax							
0.425" dia.	9 dB / 100 ft.	190 W	12"	PE3435-12	\$64.60	\$60.08	\$55.56
			24"	PE3435-24	\$70.35	\$65.43	\$60.50
			36"	PE3435-36	\$76.10	\$70.77	\$65.45
			48"	PE3435-48	\$81.85	\$76.12	\$70.39
			60"	PE3435-60	\$87.60	\$81.47	\$75.34
Any	PE3435-XX	See Website for Pricing					
50 Ohm, RG223/U Coax							
0.216" dia.	16.5 dB / 100 ft.	53 W	12"	PE3414-12	\$31.40	\$29.20	\$27.00
			24"	PE3414-24	\$33.60	\$31.25	\$28.90
			36"	PE3414-36	\$35.80	\$33.29	\$30.79
			48"	PE3414-48	\$38.00	\$35.34	\$32.68
			60"	PE3414-60	\$40.25	\$37.43	\$34.62
Any	PE3414-XX	See Website for Pricing					
See website for the following cable(s)							
50 Ohm, RG303/U Coax				PE33013			
50 Ohm, RG316/U Coax							
0.102" dia.	30 dB / 100 ft.	160 W	12"	PE3747-12	\$40.80	\$37.94	\$35.09
			24"	PE3747-24	\$42.20	\$39.25	\$36.29
			36"	PE3747-36	\$43.75	\$40.69	\$37.63
			48"	PE3747-48	\$45.15	\$41.99	\$38.83
			60"	PE3747-60	\$46.55	\$43.29	\$40.03
Any	PE3747-XX	See Website for Pricing					
See website for the following cable(s)							
50 Ohm, RG316-DS Coax				PE34316			
50 Ohm, RG393/U Coax				PE33185			
50 Ohm, RG400/U Coax							
0.195" dia.	13 dB / 100 ft.	650 W	12"	PE3608-12	\$38.85	\$36.13	\$33.41
			24"	PE3608-24	\$42.75	\$39.76	\$36.77
			36"	PE3608-36	\$46.65	\$43.38	\$40.12
			48"	PE3608-48	\$50.60	\$47.06	\$43.52
			60"	PE3608-60	\$54.50	\$50.69	\$46.87
Any	PE3608-XX	See Website for Pricing					
See website for the following cable(s)							
50 Ohm, PE-C195 Coax				PE36555			
50 Ohm, PE-C240 Coax				PE35997			
50 Ohm, PE-C300 Coax				PE35100			
50 Ohm, PE-C400 Coax				PE35886			
75 Ohm, RG59B/U Coax							
0.242" dia.	11.5 dB / 100 ft.	77 W	12"	PE3402-12	\$26.75	\$24.88	\$23.01
			24"	PE3402-24	\$27.50	\$25.58	\$23.65
			36"	PE3402-36	\$28.25	\$26.27	\$24.30
			48"	PE3402-48	\$28.95	\$26.92	\$24.90
			60"	PE3402-60	\$29.70	\$27.62	\$25.54
Any	PE3402-XX	See Website for Pricing					
See website for the following cable(s)							
75 Ohm, RG179B/U Coax				PE3430			
Standard Formable Cable Assemblies							
See website for the following cable(s)							
50 Ohm, PE-SR401FL Coax				PE34282			
50 Ohm, PE-SR402FL Coax				PE3466			
Standard Semirigid Cable Assemblies							
See website for the following cable(s)							
50 Ohm, PE-SR402AL Coax				PE34279			
50 Ohm, RG401/U Coax				PE34271			
50 Ohm, RG402/U Coax				PE3074			

TNC MALE TO TNC MALE RIGHT ANGLE



Cable	Model No.
Precision Formable Cable Assemblies	
Please see precision section, page 6-29	
50 Ohm, PE-SR402FL Coax	PE39481
50 Ohm, PE-SR402FLJ Jacketed Coax	PE39495
50 Ohm, PE-SR405FL Coax	PE39473
50 Ohm, PE-SR405FLJ Jacketed Coax	PE39487

TNC MALE TO TNC FEMALE



Cable	Model No.
Precision Formable Cable Assemblies	
Please see precision section, page 6-29	
50 Ohm, PE-SR402FL Coax	PE39482
50 Ohm, PE-SR402FLJ Jacketed Coax	PE39496
50 Ohm, PE-SR405FL Coax	PE39474
50 Ohm, PE-SR405FLJ Jacketed Coax	PE39488

TNC MALE TO REVERSE POLARITY TNC MALE



Cable Dia.	Atten.*	Max Power*	Length	Model No.	1-24	25-49	50-99
Standard Flexible Cable Assemblies							
See website for the following cable(s)							
50 Ohm, RG58C/U Coax				PE35228			
50 Ohm, RG142B/U Coax				PE35230			
50 Ohm, RG223/U Coax							
0.216" dia.	16.5 dB / 100 ft.	53 W	12"	PE35236-12	\$31.50	\$29.30	\$27.09
			24"	PE35236-24	\$33.70	\$31.34	\$28.98
			36"	PE35236-36	\$35.90	\$33.39	\$30.87
			48"	PE35236-48	\$38.10	\$35.43	\$32.77
			60"	PE35236-60	\$40.35	\$37.53	\$34.70
Any	PE35236-XX	See Website for Pricing					
See website for the following cable(s)							
50 Ohm, RG316/U Coax				PE35238			

TNC MALE RIGHT ANGLE TO TNC MALE RIGHT ANGLE



Cable	Model No.
Precision Formable Cable Assemblies	
Please see precision section, page 6-29	
50 Ohm, PE-SR402FL Coax	PE39480
50 Ohm, PE-SR402FLJ Jacketed Coax	PE39494
50 Ohm, PE-SR405FL Coax	PE39472
50 Ohm, PE-SR405FLJ Jacketed Coax	PE39486

Cable Assemblies

*Coax Performance at 1 GHz
Notes: Cable assembly max frequency may be lower than connector or coax max frequency

The Telstar 1 satellite, launched in July 1962, carried the first transatlantic live television pictures via satellite.



Free Freight Available via UPS Ground to USA & Canada



Real-Time Stock Levels & Pricing On Our WebSite



Toll-Free Technical Support (866) 727-8376



Same-Day Shipping, Even Custom Cable Assemblies

Cable Assemblies

*Coax Performance at 1 GHz
Notes: Cable assembly max frequency may be lower than connector or coax max frequency



Cable Dia.	Atten.*	Max Power*	Length	Model No.	1-24	25-49	50-99
------------	---------	------------	--------	-----------	------	-------	-------

Standard Flexible Cable Assemblies

50 Ohm, RG58/U Coax

0.195" dia.	20 dB / 100 ft.	44 W	12"	PE3497-12	\$27.75	\$25.81	\$23.87
			24"	PE3497-24	\$28.30	\$26.32	\$24.34
			36"	PE3497-36	\$28.85	\$26.83	\$24.81
			48"	PE3497-48	\$29.35	\$27.30	\$25.24
			60"	PE3497-60	\$29.90	\$27.81	\$25.71
Any	PE3497-XX	See Website for Pricing					

50 Ohm, RG142B/U Coax

0.195" dia.	13 dB / 100 ft.	650 W	12"	PE3551-12	\$28.10	\$26.13	\$24.17
			24"	PE3551-24	\$32.25	\$29.99	\$27.74
			36"	PE3551-36	\$36.40	\$33.85	\$31.30
			48"	PE3551-48	\$40.55	\$37.71	\$34.87
			60"	PE3551-60	\$44.65	\$41.52	\$38.40
Any	PE3551-XX	See Website for Pricing					

See website for the following cable(s)

50 Ohm, RG174A/U Coax	PE34506
50 Ohm, RG178B/U Coax	PE39255
50 Ohm, RG213/U Coax	PE33969
50 Ohm, RG214/U Coax	PE33701

50 Ohm, RG223/U Coax

0.216" dia.	16.5 dB / 100 ft.	53 W	12"	PE3498-12	\$26.20	\$24.37	\$22.53
			24"	PE3498-24	\$28.40	\$26.41	\$24.42
			36"	PE3498-36	\$30.60	\$28.46	\$26.32
			48"	PE3498-48	\$32.80	\$30.50	\$28.21
			60"	PE3498-60	\$35.00	\$32.55	\$30.10
Any	PE3498-XX	See Website for Pricing					

See website for the following cable(s)

50 Ohm, RG316/U Coax	PE33383
----------------------	---------

50 Ohm, RG400/U Coax

0.195" dia.	13 dB / 100 ft.	650 W	12"	PE33535-12	\$33.00	\$30.69	\$28.38
			24"	PE33535-24	\$36.95	\$34.36	\$31.78
			36"	PE33535-36	\$40.80	\$37.94	\$35.09
			48"	PE33535-48	\$44.75	\$41.62	\$38.49
			60"	PE33535-60	\$48.65	\$45.24	\$41.84
Any	PE33535-XX	See Website for Pricing					

TNC FEMALE BULKHEAD TO UMCX PLUG RIGHT ANGLE
SEE MOUNTING HOLE SECTION ON PAGE 246



Cable	Model No.
-------	-----------

Standard Flexible Cable Assemblies

See website for the following cable(s)

50 Ohm, RG178B/U Coax	PE38304
-----------------------	---------

TNC FEMALE BULKHEAD TO MMCX PLUG RIGHT ANGLE
SEE MOUNTING HOLE SECTION ON PAGE 246



Cable	Model No.
-------	-----------

Precision Formable Cable Assemblies

Please see precision section, page 6-29

50 Ohm, PE-SR405FL Coax	PE39478	11
50 Ohm, PE-SR405FLJ Jacketed Coax	PE39492	12

TNC FEMALE BULKHEAD TO MMCX PLUG RIGHT ANGLE
SEE MOUNTING HOLE SECTION ON PAGE 246



Cable Dia.	Atten.*	Max Power*	Length	Model No.	1-24	25-49	50-99
------------	---------	------------	--------	-----------	------	-------	-------

Standard Flexible Cable Assemblies

50 Ohm, RG188A/U Coax

0.110" dia.	30 dB / 100 ft.	160 W	12"	PE35635-12	\$53.20	\$49.48	\$45.75
			24"	PE35635-24	\$54.90	\$51.06	\$47.21
			36"	PE35635-36	\$56.55	\$52.59	\$48.63
			48"	PE35635-48	\$58.25	\$54.17	\$50.10
			60"	PE35635-60	\$59.95	\$55.75	\$51.56
Any	PE35635-XX	See Website for Pricing					

TNC FEMALE BULKHEAD TO MCX PLUG RIGHT ANGLE
SEE MOUNTING HOLE SECTION ON PAGE 246



Cable Dia.	Atten.*	Max Power*	Length	Model No.	1-24	25-49	50-99
------------	---------	------------	--------	-----------	------	-------	-------

Standard Flexible Cable Assemblies

50 Ohm, RG174A/U Coax

0.100" dia.	31 dB / 100 ft.	16 W	12"	PE33799-12	\$44.50	\$41.39	\$38.27
			24"	PE33799-24	\$44.90	\$41.76	\$38.61
			36"	PE33799-36	\$45.35	\$42.18	\$39.00
			48"	PE33799-48	\$45.80	\$42.59	\$39.39
			60"	PE33799-60	\$46.20	\$42.97	\$39.73
Any	PE33799-XX	See Website for Pricing					

TNC FEMALE BULKHEAD TO 75 OHM MCX JACK
SEE MOUNTING HOLE SECTION ON PAGE 246



Cable	Model No.
-------	-----------

Precision Formable Cable Assemblies

Please see precision section, page 6-29

50 Ohm, PE-SR405FL Coax	PE39477	15
50 Ohm, PE-SR405FLJ Jacketed Coax	PE39491	16

REVERSE POLARITY TNC MALE TO BNC MALE



Cable	Model No.
-------	-----------

Standard Flexible Cable Assemblies

See website for the following cable(s)

50 Ohm, RG58C/U Coax	PE35229	17
----------------------	---------	----

The TNC connector, which stands for "Threaded Neill Concelman", is a threaded version of the BNC connector.

REVERSE POLARITY TNC FEMALE BULKHEAD TO UMCX PLUG RIGHT ANGLE

SEE MOUNTING HOLE SECTION ON PAGE 246



Cable Model No.

Standard Flexible Cable Assemblies

See website for the following cable(s)

50 Ohm, RG178B/U Coax	PE38303	1
-----------------------	---------	---

7/16 DIN MALE TO 7/16 DIN MALE



Cable Dia.	Atten.*	Max Power*	Length	Model No.	1-24	25-49	50-99
------------	---------	------------	--------	-----------	------	-------	-------

Standard Flexible Cable Assemblies

See website for the following cable(s)

50 Ohm, RG217/U Coax	PE36134	2
50 Ohm, RG218/U Coax	PE35900	3
50 Ohm, RG393/U Coax	PE3205	4
50 Ohm, PE-C195 Coax	PE37952	5
50 Ohm, PE-C400 Coax	PE37954	6
50 Ohm, PE-C600 Coax	PE37955	7

Standard Formable Cable Assemblies

See website for the following cable(s)

50 Ohm, 1/2" Helical Coax	PE37971	8
---------------------------	---------	---

Standard Flexible Cable Assemblies

50 Ohm, 1/2" Flexible Coax, Low PIM, Low Loss

Cable Dia.	Atten.*	Max Power*	Length	Model No.	1-24	25-49	50-99
0.63" dia.	2.1 dB / 100 ft.	- W	36"	PE39802-36			
			48"	PE39802-48			
			72"	PE39802-72			
			96"	PE39802-96			
			120"	PE39802-120			
			144"	PE39802-144			
			168"	PE39802-168			
			192"	PE39802-192			
			240"	PE39802-240			
			Any	PE39802-XX			See Website for Pricing

50 Ohm, 1/2" Super Flexible Coax, Low PIM, Low Loss

Cable Dia.	Atten.*	Max Power*	Length	Model No.	1-24	25-49	50-99
0.53" dia.	3.3 dB / 100 ft.	- W	36"	PE39803-36			
			48"	PE39803-48			
			72"	PE39803-72			
			96"	PE39803-96			
			120"	PE39803-120			
			144"	PE39803-144			
			168"	PE39803-168			
			192"	PE39803-192			
			240"	PE39803-240			
			Any	PE39803-XX			See Website for Pricing

7/16 DIN MALE TO 7/16 DIN MALE RIGHT ANGLE



Cable Model No.

Standard Flexible Cable Assemblies

See website for the following cable(s)

50 Ohm, RG393/U Coax	PE36657	11
----------------------	---------	----

Standard Formable Cable Assemblies

See website for the following cable(s)

50 Ohm, 1/2" Helical Coax	PE37973	12
---------------------------	---------	----

7/16 DIN MALE TO 7/16 DIN FEMALE



Cable Model No.

Standard Flexible Cable Assemblies

See website for the following cable(s)

50 Ohm, PE-C400 Coax	PE37962	13
50 Ohm, PE-C600 Coax	PE37963	14

Standard Formable Cable Assemblies

See website for the following cable(s)

50 Ohm, 1/2" Helical Coax	PE37972	15
---------------------------	---------	----

UHF MALE TO UHF MALE



Cable Dia.	Atten.*	Max Power*	Length	Model No.	1-24	25-49	50-99
------------	---------	------------	--------	-----------	------	-------	-------

Standard Flexible Cable Assemblies

See website for the following cable(s)

52 Ohm, RG8A/U Coax	PE3623	16
---------------------	--------	----

50 Ohm, RG58C/U Coax

Cable Dia.	Atten.*	Max Power*	Length	Model No.	1-24	25-49	50-99
0.195" dia.	20 dB / 100 ft.	44 W	12"	PE3015-12	\$25.40	\$23.62	\$21.84
			24"	PE3015-24	\$25.95	\$24.13	\$22.32
			36"	PE3015-36	\$26.50	\$24.65	\$22.79
			48"	PE3015-48	\$27.00	\$25.11	\$23.22
			60"	PE3015-60	\$27.55	\$25.62	\$23.69
			Any	PE3015-XX			See Website for Pricing

See website for the following cable(s)

50 Ohm, RG213/U Coax	PE3635	18
50 Ohm, RG214/U Coax	PE3796	19
50 Ohm, RG223/U Coax	PE3845	20
50 Ohm, RG393/U Coax	PE33267	21
50 Ohm, PE-B405 Coax	PE3159	22
50 Ohm, PE-C195 Coax	PE38632	23
75 Ohm, RG59B/U Coax	PE3580	24

UHF MALE TO BNC MALE



Cable Dia.	Atten.*	Max Power*	Length	Model No.	1-24	25-49	50-99
------------	---------	------------	--------	-----------	------	-------	-------

Standard Flexible Cable Assemblies

50 Ohm, RG58C/U Coax

Cable Dia.	Atten.*	Max Power*	Length	Model No.	1-24	25-49	50-99
0.195" dia.	20 dB / 100 ft.	44 W	12"	PE3057-12	\$24.95	\$23.20	\$21.46
			24"	PE3057-24	\$25.50	\$23.72	\$21.93
			36"	PE3057-36	\$26.00	\$24.18	\$22.36
			48"	PE3057-48	\$26.55	\$24.69	\$22.83
			60"	PE3057-60	\$27.10	\$25.20	\$23.31
			Any	PE3057-XX			See Website for Pricing

See website for the following cable(s)

93 Ohm, RG62A/U Coax	PE34587	26
50 Ohm, RG142B/U Coax	PE3898	27
50 Ohm, RG214/U Coax	PE33438	28

50 Ohm, RG223/U Coax

Cable Dia.	Atten.*	Max Power*	Length	Model No.	1-24	25-49	50-99
0.216" dia.	16.5 dB / 100 ft.	53 W	12"	PE3803-12	\$23.20	\$21.58	\$19.95
			24"	PE3803-24	\$25.25	\$23.48	\$21.72
			36"	PE3803-36	\$27.45	\$25.53	\$23.61
			48"	PE3803-48	\$29.65	\$27.57	\$25.50
			60"	PE3803-60	\$31.85	\$29.62	\$27.39
Any	PE3803-XX			See Website for Pricing			

See website for the following cable(s)

50 Ohm, RG225/U Coax	PE34589	30
----------------------	---------	----

*Coax Performance at 1 GHz
Notes: Cable assembly max frequency may be lower than connector or coax max frequency

Continued on Next Page

Continued from Previous Page

UHF MALE TO BNC MALE



Cable Dia.	Atten.*	Max Power*	Length	Model No.	1-24	25-49	50-99
50 Ohm, RG400/U Coax							
0.195" dia.	13 dB / 100 ft.	650 W	12"	PE3231-12	\$30.65	\$28.50	\$26.36
			24"	PE3231-24	\$36.05	\$33.53	\$31.00
			36"	PE3231-36	\$41.50	\$38.60	\$35.69
			48"	PE3231-48	\$46.95	\$43.66	\$40.38
			60"	PE3231-60	\$52.35	\$48.69	\$45.02
		Any	PE3231-XX	See Website for Pricing			
See website for the following cable(s)							
50 Ohm, PE-C195 Coax				PE38674			
75 Ohm, RG59B/U Coax				PE3543			

MINI UHF MALE TO MINI UHF MALE



Cable	Model No.
Standard Flexible Cable Assemblies	
See website for the following cable(s)	
50 Ohm, RG58C/U Coax	PE3258
50 Ohm, RG142B/U Coax	PE3263

FME JACK TO FME JACK



Cable	Model No.
Standard Flexible Cable Assemblies	
See website for the following cable(s)	
50 Ohm, RG58C/U Coax	PE34856

FME PLUG TO NMO MOUNT CONNECTOR

NMO MOUNT REQUIRES 3/4" HOLE, 1 1/8"-18 THREAD AND INSTALLS FROM ABOVE.



Cable	Model No.
Standard Flexible Cable Assemblies	
See website for the following cable(s)	
50 Ohm, RG58C/U Coax	PE37842

FME JACK TO BNC MALE



Cable	Model No.
Standard Flexible Cable Assemblies	
See website for the following cable(s)	
50 Ohm, RG58C/U Coax	PE34862

The FME connector is "For Mobile Equipment". It offers excellent performance from DC to 2GHz.

FME JACK TO NMO MOUNT CONNECTOR

NMO MOUNT REQUIRES 3/4" HOLE, 1 1/8"-18 THREAD AND INSTALLS FROM ABOVE.



Cable	Model No.
Standard Flexible Cable Assemblies	
See website for the following cable(s)	
50 Ohm, RG58C/U Coax	PE37843

FME JACK BULKHEAD TO UMCX PLUG

SEE MOUNTING HOLE SECTION ON PAGE 246



Cable	Model No.
Standard Flexible Cable Assemblies	
See website for the following cable(s)	
50 Ohm, 1.13mm Coax	PE38857
	PE38858

SMC PLUG TO SMC PLUG



Cable Dia.	Atten.*	Max Power*	Length	Model No.	1-24	25-49	50-99
Standard Flexible Cable Assemblies							
See website for the following cable(s)							
50 Ohm, RG58C/U Coax				PE33641			
50 Ohm, RG174A/U Coax							
0.100" dia.	31 dB / 100 ft.	16 W	12"	PE3883-12	\$32.20	\$29.95	\$27.69
			24"	PE3883-24	\$32.65	\$30.36	\$28.08
			36"	PE3883-36	\$33.05	\$30.74	\$28.42
			48"	PE3883-48	\$33.50	\$31.16	\$28.81
			60"	PE3883-60	\$33.95	\$31.57	\$29.20
		Any	PE3883-XX	See Website for Pricing			
See website for the following cable(s)							
50 Ohm, RG178B/U Coax				PE3902			
50 Ohm, RG188A/U Coax				PE3595			
50 Ohm, RG188-DS Coax				PE33154			
50 Ohm, RG196A/U Coax				PE3596			
50 Ohm, RG316/U Coax							
0.102" dia.	30 dB / 100 ft.	160 W	12"	PE3808-12	\$34.15	\$31.76	\$29.37
			24"	PE3808-24	\$36.55	\$33.99	\$31.43
			36"	PE3808-36	\$38.95	\$36.22	\$33.50
			48"	PE3808-48	\$41.35	\$38.46	\$35.56
			60"	PE3808-60	\$43.75	\$40.69	\$37.63
		Any	PE3808-XX	See Website for Pricing			
See website for the following cable(s)							
50 Ohm, RG316-DS Coax				PE34721			

SMC PLUG TO SMC PLUG RIGHT ANGLE



Cable	Model No.
Standard Flexible Cable Assemblies	
See website for the following cable(s)	
50 Ohm, RG174A/U Coax	PE33556
50 Ohm, RG178B/U Coax	PE34492
50 Ohm, RG188A/U Coax	PE3600
50 Ohm, RG196A/U Coax	PE3601

Cable Assemblies

*Coax Performance at 1 GHz
Notes: Cable assembly max frequency may be lower than connector or coax max frequency

Continued on Next Page

Continued from Previous Page

SMC PLUG TO SMC PLUG RIGHT ANGLE



Cable Model No.

50 Ohm, RG316/U Coax	PE33363	1
----------------------	---------	---

SMC PLUG TO SMC JACK BULKHEAD

SEE MOUNTING HOLE SECTION ON PAGE 246



Cable Model No.

Standard Flexible Cable Assemblies

See website for the following cable(s)

50 Ohm, RG58C/U Coax	PE34503	2
50 Ohm, RG174A/U Coax	PE33580	3
50 Ohm, RG178B/U Coax	PE33352	4
50 Ohm, RG316/U Coax	PE33690	5

SMC PLUG RIGHT ANGLE TO SMC PLUG RIGHT ANGLE



Cable Model No.

Standard Flexible Cable Assemblies

See website for the following cable(s)

50 Ohm, RG58C/U Coax	PE33643	6
50 Ohm, RG174A/U Coax	PE3918	7
50 Ohm, RG178B/U Coax	PE3765	8
50 Ohm, RG188A/U Coax	PE3597	9
50 Ohm, RG316/U Coax	PE3919	10
50 Ohm, RG316-DS Coax	PE34462	11

SMC PLUG RIGHT ANGLE TO SMC JACK BULKHEAD

SEE MOUNTING HOLE SECTION ON PAGE 246



Cable Model No.

Standard Flexible Cable Assemblies

See website for the following cable(s)

50 Ohm, RG174A/U Coax	PE34078	12
-----------------------	---------	----

SMC PLUG TO BNC MALE



Cable Dia.	Atten.*	Max Power*	Length	Model No.	1-24	25-49	50-99
------------	---------	------------	--------	-----------	------	-------	-------

Standard Flexible Cable Assemblies

See website for the following cable(s)

50 Ohm, RG58C/U Coax	PE3244	13
50 Ohm, RG142B/U Coax	PE3240	14

50 Ohm, RG174A/U Coax							
Cable Dia.	Atten.*	Max Power*	Length	Model No.	1-24	25-49	50-99
0.100" dia.	31 dB / 100 ft.	16 W	12"	PE3660-12	\$30.55	\$28.41	\$26.27
			24"	PE3660-24	\$30.95	\$28.78	\$26.62
			36"	PE3660-36	\$31.40	\$29.20	\$27.00
			48"	PE3660-48	\$31.80	\$29.57	\$27.35
			60"	PE3660-60	\$32.25	\$29.99	\$27.74
			Any	PE3660-XX	See Website for Pricing		

SMC PLUG TO BNC MALE



Cable Dia.	Atten.*	Max Power*	Length	Model No.	1-24	25-49	50-99
------------	---------	------------	--------	-----------	------	-------	-------

See website for the following cable(s)

50 Ohm, RG188A/U Coax	PE3641	16
50 Ohm, RG223/U Coax	PE3238	17
50 Ohm, RG316/U Coax	PE3849	18
50 Ohm, RG316-DS Coax	PE3437	19

SMC JACK BULKHEAD TO UMCX PLUG RIGHT ANGLE

SEE MOUNTING HOLE SECTION ON PAGE 246



Cable Model No.

Standard Flexible Cable Assemblies

See website for the following cable(s)

50 Ohm, RG178B/U Coax	PE39035	20
-----------------------	---------	----

10-32 MALE TO 10-32 MALE



Cable Model No.

Standard Flexible Cable Assemblies

See website for the following cable(s)

50 Ohm, RG174A/U Coax	PE36520	21
50 Ohm, RG178B/U Coax	PE36522	22
50 Ohm, RG316/U Coax	PE36524	23

10-32 MALE TO 10-32 MALE RIGHT ANGLE



Cable Model No.

Standard Flexible Cable Assemblies

See website for the following cable(s)

50 Ohm, RG174A/U Coax	PE36526	24
-----------------------	---------	----

10-32 MALE TO BNC MALE



Cable Dia.	Atten.*	Max Power*	Length	Model No.	1-24	25-49	50-99
------------	---------	------------	--------	-----------	------	-------	-------

Standard Flexible Cable Assemblies

50 Ohm, RG174A/U Coax

0.100" dia.	31 dB / 100 ft.	16 W	12"	PE36538-12	\$41.95	\$39.01	\$36.08
			24"	PE36538-24	\$42.25	\$39.29	\$36.34
			36"	PE36538-36	\$42.55	\$39.57	\$36.59
			48"	PE36538-48	\$42.80	\$39.80	\$36.81
			60"	PE36538-60	\$43.05	\$40.04	\$37.02
			Any	PE36538-XX	See Website for Pricing		

See website for the following cable(s)

50 Ohm, RG178B/U Coax	PE36540	26
50 Ohm, RG316/U Coax	PE36542	27

Cable Assemblies

*Coax Performance at 1 GHz
Notes: Cable assembly max frequency may be lower than connector or coax max frequency



Free Freight Available
via UPS Ground
to USA & Canada



Real-Time Stock
Levels & Pricing
On Our WebSite



Toll-Free Technical
Support
(866) 727-8376





Same-Day Shipping,
Even Custom
Cable Assemblies

Cable Assemblies

*Coax Performance at 1 GHz
Notes: Cable assembly max frequency may be lower than connector or coax max frequency

SC MALE TO SC MALE							
							
Cable				Model No.			
Standard Flexible Cable Assemblies							
See website for the following cable(s)							
50 Ohm, RG217/U Coax	PE34445	1					
50 Ohm, RG225/U Coax	PE34447	2					
50 Ohm, RG393/U Coax	PE3416	3					

LC MALE TO LC MALE							
							
Cable				Model No.			
Standard Flexible Cable Assemblies							
See website for the following cable(s)							
50 Ohm, RG217/U Coax	PE33537	4					
50 Ohm, RG218/U Coax	PE3960	5					
50 Ohm, RG393/U Coax	PE33539	6					

HN MALE TO HN MALE							
							
Cable				Model No.			
Standard Flexible Cable Assemblies							
See website for the following cable(s)							
52 Ohm, RG8A/U Coax	PE33304	7					
50 Ohm, RG58C/U Coax	PE3852	8					
50 Ohm, RG142B/U Coax	PE3083	9					
50 Ohm, RG213/U Coax	PE3038	10					
50 Ohm, RG214/U Coax							
0.425" dia.	9 dB / 100 ft.	190 W	12"	PE3095-12	\$87.40	\$81.28	\$75.16
			24"	PE3095-24	\$93.15	\$86.63	\$80.11
			36"	PE3095-36	\$98.90	\$91.98	\$85.05
			48"	PE3095-48	\$104.65	\$97.32	\$90.00
			60"	PE3095-60	\$110.40	\$102.67	\$94.94
Any	PE3095-XX	See Website for Pricing					
50 Ohm, RG217/U Coax							
0.545" dia.	5.8 dB / 100 ft.	260 W	12"	PE33370-12	\$109.30	\$101.65	\$94.00
			24"	PE33370-24	\$111.75	\$103.93	\$96.11
			36"	PE33370-36	\$114.10	\$106.11	\$98.13
			48"	PE33370-48	\$116.70	\$108.53	\$100.36
			60"	PE33370-60	\$119.10	\$110.76	\$102.43
Any	PE33370-XX	See Website for Pricing					
See website for the following cable(s)							
50 Ohm, RG223/U Coax	PE3357	13					
50 Ohm, RG393/U Coax							
0.390" dia.	7.5 dB / 100 ft.	1700 W	12"	PE3340-12	\$94.10	\$87.51	\$80.93
			24"	PE3340-24	\$106.15	\$98.72	\$91.29
			36"	PE3340-36	\$118.15	\$109.88	\$101.61
			48"	PE3340-48	\$130.15	\$121.04	\$111.93
			60"	PE3340-60	\$142.20	\$132.25	\$122.29
Any	PE3340-XX	See Website for Pricing					
See website for the following cable(s)							
50 Ohm, RG400/U Coax	PE33938	15					
75 Ohm, RG59B/U Coax	PE34436	16					

QMA MALE TO QMA MALE							
							
Cable				Model No.			
Standard Flexible Cable Assemblies							
See website for the following cable(s)							
50 Ohm, RG58C/U Coax	PE38271	17					
50 Ohm, RG316/U Coax	PE38270	18					
50 Ohm, RG316-DS Coax							
0.114" dia.	30 dB / 100 ft.	160 W	12"	PE38161-12	\$45.50	\$42.32	\$39.13
			24"	PE38161-24	\$47.75	\$44.41	\$41.07
			36"	PE38161-36	\$50.05	\$46.55	\$43.04
			48"	PE38161-48	\$52.30	\$48.64	\$44.98
			60"	PE38161-60	\$54.60	\$50.78	\$46.96
Any	PE38161-XX	See Website for Pricing					
See website for the following cable(s)							
50 Ohm, PE-C195 Coax	PE38272	20					

QN MALE TO QN MALE							
							
Cable				Model No.			
Standard Flexible Cable Assemblies							
See website for the following cable(s)							
50 Ohm, RG58C/U Coax	PE38448	21					
50 Ohm, RG223/U Coax	PE38447	22					

SMP FEMALE TO SMP FEMALE							
							
Cable				Model No.			
Standard Formable Cable Assemblies							
50 Ohm, PE-SR047FL Coax							
0.047" dia.	40 dB / 100 ft.	32 W	12"	PE36148-12	\$68.20	\$63.43	\$58.65
			24"	PE36148-24	\$73.85	\$68.68	\$63.51
			36"	PE36148-36	\$79.50	\$73.94	\$68.37
			48"	PE36148-48	\$85.20	\$79.24	\$73.27
			60"	PE36148-60	\$90.85	\$84.49	\$78.13
Any	PE36148-XX	See Website for Pricing					
50 Ohm, PE-SR405FL Coax							
0.085" dia.	22 dB / 100 ft.	130 W	12"	PE36152-12	\$81.30	\$75.61	\$69.92
			24"	PE36152-24	\$89.50	\$83.24	\$76.97
			36"	PE36152-36	\$97.75	\$90.91	\$84.07
			48"	PE36152-48	\$105.95	\$98.53	\$91.12
			60"	PE36152-60	\$114.20	\$106.21	\$98.21
Any	PE36152-XX	See Website for Pricing					
Standard Semirigid Cable Assemblies							
See website for the following cable(s)							
50 Ohm, PE-047SR Coax	PE36146	25					
50 Ohm, RG405/U Coax	PE36150	26					

SMP FEMALE TO SMP FEMALE RIGHT ANGLE							
							
Cable				Model No.			
Standard Formable Cable Assemblies							
See website for the following cable(s)							
50 Ohm, PE-SR047FL Coax	PE36156	27					
50 Ohm, PE-SR405FL Coax	PE36160	28					

Continued on Next Page

Continued from Previous Page

SMP FEMALE TO SMP FEMALE RIGHT ANGLE



Cable Model No.

Standard Semirigid Cable Assemblies

See website for the following cable(s)		
50 Ohm, PE-047SR Coax	PE36154	1
50 Ohm, RG405/U Coax	PE36158	2

UMCX PLUG TO UMCX PLUG



Cable Dia. Atten.* Max Power* Length Model No. 1-24 25-49 50-99

Standard Flexible Cable Assemblies

50 Ohm, 1.13mm Coax							
0.750" dia.	45 dB / 100 ft.	78 W	3"	PE38295-3	\$5.37	\$4.99	\$4.62
			6"	PE38295-6	\$5.93	\$5.51	\$5.10
			12"	PE38295-12	\$6.49	\$6.04	\$5.58
			Any	PE38295-XX	See Website for Pricing		

UMCX PLUG RIGHT ANGLE TO MCX JACK BULKHEAD

SEE MOUNTING HOLE SECTION ON PAGE 246



Cable Model No.

Standard Flexible Cable Assemblies

See website for the following cable(s)	
50 Ohm, RG178B/U Coax	PE38889

UMCX PLUG RIGHT ANGLE TO REVERSE POLARITY MCX JACK BULKHEAD

SEE MOUNTING HOLE SECTION ON PAGE 246



Cable Model No.

Standard Flexible Cable Assemblies

See website for the following cable(s)	
50 Ohm, RG178B/U Coax	PE38302

UMCX PLUG TO 75 OHM MCX PLUG



Cable Model No.

Standard Flexible Cable Assemblies

See website for the following cable(s)		
50 Ohm, 1.13mm Coax	PE38298	4

UMCX PLUG RIGHT ANGLE TO SSMB PLUG



Cable Model No.

Standard Flexible Cable Assemblies

See website for the following cable(s)	
50 Ohm, RG178B/U Coax	PE38930

UMCX PLUG RIGHT ANGLE TO MMCX PLUG RIGHT ANGLE



Cable Model No.

Standard Flexible Cable Assemblies

See website for the following cable(s)		
50 Ohm, RG178B/U Coax	PE39078	5

UMCX PLUG RIGHT ANGLE TO OPEN



Cable Dia. Atten.* Max Power* Length Model No. 1-24 25-49 50-99

Standard Flexible Cable Assemblies

50 Ohm, RG178B/U Coax							
0.750" dia.	45.0 dB / 100 ft.	78 W	3"	PE38296-3	\$35.05	\$32.60	\$30.14
			6"	PE38296-6	\$19.56	\$18.19	\$16.82
			9"	PE38296-9	\$35.05	\$32.60	\$30.14
			12"	PE38296-12	\$21.79	\$20.26	\$18.74
			18"	PE38296-18	\$25.35	\$23.58	\$21.80
			24"	PE38296-24	\$26.24	\$24.40	\$22.57
Any	PE38296-XX	See Website for Pricing					

UMCX PLUG RIGHT ANGLE TO MCX PLUG



Cable Model No.

Standard Flexible Cable Assemblies

See website for the following cable(s)		
50 Ohm, RG178B/U Coax	PE38890	6

UMCX PLUG RIGHT ANGLE TO MCX PLUG RIGHT ANGLE



Cable Model No.

Standard Flexible Cable Assemblies

See website for the following cable(s)		
50 Ohm, RG178B/U Coax	PE38502	7

MMCX PLUG TO MMCX PLUG



Cable Dia. Atten.* Max Power* Length Model No. 1-24 25-49 50-99

Standard Flexible Cable Assemblies

50 Ohm, RG174A/U Coax							
0.100" dia.	31 dB / 100 ft.	16 W	12"	PE34879-12	\$38.00	\$35.34	\$32.68
			24"	PE34879-24	\$38.40	\$35.71	\$33.02
			36"	PE34879-36	\$38.85	\$36.13	\$33.41
			48"	PE34879-48	\$39.25	\$36.50	\$33.76
			60"	PE34879-60	\$39.70	\$36.92	\$34.14
			Any	PE34879-XX	See Website for Pricing		

Cable Assemblies

*Coax Performance at 1 GHz
Notes: Cable assembly max frequency may be lower than connector or coax max frequency

Continued on Next Page

Continued from Previous Page

MMCX PLUG TO MMCX PLUG



Cable Dia.	Atten.*	Max Power*	Length	Model No.	1-24	25-49	50-99
50 Ohm, RG178B/U Coax							
0.750" dia.	45 dB / 100 ft.	78 W	12"	PE34598-12	\$37.65	\$35.01	\$32.38
			24"	PE34598-24	\$38.40	\$35.71	\$33.02
			36"	PE34598-36	\$39.15	\$36.41	\$33.67
			48"	PE34598-48	\$39.85	\$37.06	\$34.27
			60"	PE34598-60	\$40.60	\$37.76	\$34.92
Any	PE34598-XX	See Website for Pricing					
See website for the following cable(s)							
50 Ohm, RG188A/U Coax				PE34885			
50 Ohm, RG196A/U Coax				PE34891			
50 Ohm, RG316/U Coax							
0.102" dia.	30 dB / 100 ft.	160 W	12"	PE34240-12	\$38.85	\$36.13	\$33.41
			24"	PE34240-24	\$40.35	\$37.53	\$34.70
			36"	PE34240-36	\$41.70	\$38.78	\$35.86
			48"	PE34240-48	\$43.05	\$40.04	\$37.02
			60"	PE34240-60	\$44.55	\$41.43	\$38.31
Any	PE34240-XX	See Website for Pricing					

MMCX PLUG TO MMCX PLUG RIGHT ANGLE



Cable Dia.	Atten.*	Max Power*	Length	Model No.	1-24	25-49	50-99
Standard Flexible Cable Assemblies							
50 Ohm, RG174A/U Coax							
0.100" dia.	31 dB / 100 ft.	16 W	12"	PE34881-12	\$45.40	\$42.22	\$39.04
			24"	PE34881-24	\$45.85	\$42.64	\$39.43
			36"	PE34881-36	\$46.30	\$43.06	\$39.82
			48"	PE34881-48	\$46.70	\$43.43	\$40.16
			60"	PE34881-60	\$47.15	\$43.85	\$40.55
Any	PE34881-XX	See Website for Pricing					
See website for the following cable(s)							
50 Ohm, RG178B/U Coax				PE34883			
50 Ohm, RG188A/U Coax				PE34889			
50 Ohm, RG316/U Coax				PE34895			
Standard Formable Cable Assemblies							
See website for the following cable(s)							
50 Ohm, PE-SR047FL Coax				PE38322			

MMCX PLUG RIGHT ANGLE TO BNC FEMALE BULKHEAD

SEE MOUNTING HOLE SECTION ON PAGE 246



Cable Dia.	Atten.*	Max Power*	Length	Model No.	1-24	25-49	50-99
Standard Flexible Cable Assemblies							
50 Ohm, RG174A/U Coax							
0.100" dia.	31 dB / 100 ft.	16 W	12"	PE36738-12	\$45.20	\$42.04	\$38.87
			24"	PE36738-24	\$45.65	\$42.45	\$39.26
			36"	PE36738-36	\$46.10	\$42.87	\$39.65
			48"	PE36738-48	\$46.50	\$43.25	\$39.99
			60"	PE36738-60	\$46.95	\$43.66	\$40.38
Any	PE36738-XX	See Website for Pricing					

MCX PLUG TO MCX PLUG



Cable Dia.	Atten.*	Max Power*	Length	Model No.	1-24	25-49	50-99
Standard Flexible Cable Assemblies							
50 Ohm, RG174A/U Coax							
0.100" dia.	31 dB / 100 ft.	16 W	12"	PE3295-12	\$33.10	\$30.78	\$28.47
			24"	PE3295-24	\$33.55	\$31.20	\$28.85
			36"	PE3295-36	\$34.00	\$31.62	\$29.24
			48"	PE3295-48	\$34.40	\$31.99	\$29.58
			60"	PE3295-60	\$34.85	\$32.41	\$29.97
Any	PE3295-XX	See Website for Pricing					
See website for the following cable(s)							
50 Ohm, RG188A/U Coax				PE3290			
50 Ohm, RG316/U Coax							
0.102" dia.	30 dB / 100 ft.	160 W	12"	PE3297-12	\$35.10	\$32.64	\$30.19
			24"	PE3297-24	\$37.45	\$34.83	\$32.21
			36"	PE3297-36	\$39.75	\$36.97	\$34.19
			48"	PE3297-48	\$41.25	\$38.36	\$35.48
			60"	PE3297-60	\$42.55	\$39.57	\$36.59
Any	PE3297-XX	See Website for Pricing					
50 Ohm, RG316-DS Coax							
0.114" dia.	30 dB / 100 ft.	160 W	12"	PE36799-12	\$34.95	\$32.50	\$30.06
			24"	PE36799-24	\$37.25	\$34.64	\$32.04
			36"	PE36799-36	\$39.50	\$36.74	\$33.97
			48"	PE36799-48	\$41.75	\$38.83	\$35.91
			60"	PE36799-60	\$44.05	\$40.97	\$37.88
Any	PE36799-XX	See Website for Pricing					

MCX PLUG TO MCX PLUG RIGHT ANGLE



Cable	Model No.
Standard Flexible Cable Assemblies	
See website for the following cable(s)	
50 Ohm, RG174A/U Coax	PE3314
50 Ohm, RG188A/U Coax	PE3309
50 Ohm, RG196A/U Coax	PE3311
50 Ohm, RG316/U Coax	PE3316

MCX PLUG RIGHT ANGLE TO MCX PLUG RIGHT ANGLE



Cable Dia.	Atten.*	Max Power*	Length	Model No.	1-24	25-49	50-99
Standard Flexible Cable Assemblies							
50 Ohm, RG174A/U Coax							
0.100" dia.	31 dB / 100 ft.	16 W	12"	PE3304-12	\$38.00	\$35.34	\$32.68
			24"	PE3304-24	\$38.40	\$35.71	\$33.02
			36"	PE3304-36	\$38.85	\$36.13	\$33.41
			48"	PE3304-48	\$39.25	\$36.50	\$33.76
			60"	PE3304-60	\$39.70	\$36.92	\$34.14
Any	PE3304-XX	See Website for Pricing					
50 Ohm, RG188A/U Coax							
0.110" dia.	30 dB / 100 ft.	160 W	12"	PE3299-12	\$39.25	\$36.50	\$33.76
			24"	PE3299-24	\$40.90	\$38.04	\$35.17
			36"	PE3299-36	\$42.60	\$39.62	\$36.64
			48"	PE3299-48	\$44.30	\$41.20	\$38.10
			60"	PE3299-60	\$46.00	\$42.78	\$39.56
Any	PE3299-XX	See Website for Pricing					

Cable Assemblies

*Coax Performance at 1 GHz
Notes: Cable assembly max frequency may be lower than connector or coax max frequency

Continued on Next Page

Continued from Previous Page

MCX PLUG RIGHT ANGLE TO MCX PLUG RIGHT ANGLE



Cable Dia.	Atten.*	Max Power*	Length	Model No.	1-24	25-49	50-99
See website for the following cable(s)							
50 Ohm, RG196A/U Coax				PE3301			1
50 Ohm, RG316/U Coax				PE3306			2
50 Ohm, RG316-DS Coax				PE37099			3

SMB PLUG TO SMB PLUG



Cable Dia.	Atten.*	Max Power*	Length	Model No.	1-24	25-49	50-99
Standard Flexible Cable Assemblies							
50 Ohm, RG58C/U Coax							
0.195" dia.	20 dB / 100 ft.	44 W	12"	PE33650-12	\$40.90	\$38.04	\$35.17
			24"	PE33650-24	\$41.45	\$38.55	\$35.65
			36"	PE33650-36	\$42.00	\$39.06	\$36.12
			48"	PE33650-48	\$42.55	\$39.57	\$36.59
			60"	PE33650-60	\$43.10	\$40.08	\$37.07
			Any	PE33650-XX	See Website for Pricing		
See website for the following cable(s)							
50 Ohm, RG142B/U Coax				PE33652			5
50 Ohm, RG174A/U Coax							
0.100" dia.	31 dB / 100 ft.	16 W	12"	PE3853-12	\$31.90	\$29.67	\$27.43
			24"	PE3853-24	\$32.30	\$30.04	\$27.78
			36"	PE3853-36	\$32.75	\$30.46	\$28.17
			48"	PE3853-48	\$33.20	\$30.88	\$28.55
			60"	PE3853-60	\$33.60	\$31.25	\$28.90
			Any	PE3853-XX	See Website for Pricing		
50 Ohm, RG178B/U Coax							
0.750" dia.	45 dB / 100 ft.	78 W	12"	PE33165-12	\$39.15	\$36.41	\$33.67
			24"	PE33165-24	\$39.85	\$37.06	\$34.27
			36"	PE33165-36	\$40.60	\$37.76	\$34.92
			48"	PE33165-48	\$41.35	\$38.46	\$35.56
			60"	PE33165-60	\$42.05	\$39.11	\$36.16
			Any	PE33165-XX	See Website for Pricing		
50 Ohm, RG188A/U Coax							
0.110" dia.	30 dB / 100 ft.	160 W	12"	PE3587-12	\$33.15	\$30.83	\$28.51
			24"	PE3587-24	\$34.85	\$32.41	\$29.97
			36"	PE3587-36	\$36.55	\$33.99	\$31.43
			48"	PE3587-48	\$38.25	\$35.57	\$32.90
			60"	PE3587-60	\$39.90	\$37.11	\$34.31
			Any	PE3587-XX	See Website for Pricing		
See website for the following cable(s)							
50 Ohm, RG188-DS Coax				PE3721			9
50 Ohm, RG196A/U Coax				PE3588			10
50 Ohm, RG223/U Coax				PE3166			11
50 Ohm, RG316/U Coax							
0.102" dia.	30 dB / 100 ft.	160 W	12"	PE3915-12	\$33.85	\$31.48	\$29.11
			24"	PE3915-24	\$36.25	\$33.71	\$31.18
			36"	PE3915-36	\$38.65	\$35.94	\$33.24
			48"	PE3915-48	\$41.00	\$38.13	\$35.26
			60"	PE3915-60	\$43.40	\$40.36	\$37.32
			Any	PE3915-XX	See Website for Pricing		
50 Ohm, RG316-DS Coax							
0.114" dia.	30 dB / 100 ft.	160 W	12"	PE33704-12	\$33.75	\$31.39	\$29.03
			24"	PE33704-24	\$36.00	\$33.48	\$30.96
			36"	PE33704-36	\$38.25	\$35.57	\$32.90
			48"	PE33704-48	\$40.55	\$37.71	\$34.87
			60"	PE33704-60	\$42.80	\$39.80	\$36.81
			Any	PE33704-XX	See Website for Pricing		

SMB PLUG TO SMB PLUG



Cable Dia.	Atten.*	Max Power*	Length	Model No.	1-24	25-49	50-99
See website for the following cable(s)							
50 Ohm, RG400/U Coax				PE34269			14

SMB PLUG TO SMB PLUG RIGHT ANGLE



Cable Dia.	Atten.*	Max Power*	Length	Model No.	1-24	25-49	50-99
Standard Flexible Cable Assemblies							
See website for the following cable(s)							
50 Ohm, RG58C/U Coax				PE33666			15
50 Ohm, RG174A/U Coax							
0.100" dia.	31 dB / 100 ft.	16 W	12"	PE33175-12	\$39.45	\$36.69	\$33.93
			24"	PE33175-24	\$39.85	\$37.06	\$34.27
			36"	PE33175-36	\$40.30	\$37.48	\$34.66
			48"	PE33175-48	\$40.75	\$37.90	\$35.05
			60"	PE33175-60	\$41.15	\$38.27	\$35.39
			Any	PE33175-XX	See Website for Pricing		
50 Ohm, RG188A/U Coax							
0.110" dia.	30 dB / 100 ft.	160 W	12"	PE3592-12	\$40.70	\$37.85	\$35.00
			24"	PE3592-24	\$42.40	\$39.43	\$36.46
			36"	PE3592-36	\$44.10	\$41.01	\$37.93
			48"	PE3592-48	\$45.75	\$42.55	\$39.35
			60"	PE3592-60	\$47.45	\$44.13	\$40.81
			Any	PE3592-XX	See Website for Pricing		
See website for the following cable(s)							
50 Ohm, RG188-DS Coax				PE33143			18
50 Ohm, RG223/U Coax				PE33670			19
50 Ohm, RG316/U Coax				PE33672			20
50 Ohm, RG316-DS Coax							
0.114" dia.	30 dB / 100 ft.	160 W	12"	PE34485-12	\$41.30	\$38.41	\$35.52
			24"	PE34485-24	\$43.55	\$40.50	\$37.45
			36"	PE34485-36	\$45.80	\$42.59	\$39.39
			48"	PE34485-48	\$48.10	\$44.73	\$41.37
			60"	PE34485-60	\$50.35	\$46.83	\$43.30
			Any	PE34485-XX	See Website for Pricing		

SMB PLUG TO SMB JACK BULKHEAD

SEE MOUNTING HOLE SECTION ON PAGE 246



Cable Dia.	Atten.*	Max Power*	Length	Model No.	1-24	25-49	50-99
Standard Flexible Cable Assemblies							
50 Ohm, RG58C/U Coax							
0.195" dia.	20 dB / 100 ft.	44 W	12"	PE34493-12	\$49.30	\$45.85	\$42.40
			24"	PE34493-24	\$49.85	\$46.36	\$42.87
			36"	PE34493-36	\$50.40	\$46.87	\$43.34
			48"	PE34493-48	\$50.90	\$47.34	\$43.77
			60"	PE34493-60	\$51.45	\$47.85	\$44.25
			Any	PE34493-XX	See Website for Pricing		
See website for the following cable(s)							
50 Ohm, RG142B/U Coax				PE34495			23

Cable Assemblies

*Coax Performance at 1 GHz
Notes: Cable assembly max frequency may be lower than connector or coax max frequency

Continued on Next Page

Continued from Previous Page

SMB PLUG TO SMB JACK BULKHEAD

SEE MOUNTING HOLE SECTION ON PAGE 246



Cable Dia.	Atten.*	Max Power*	Length	Model No.	1-24	25-49	50-99
50 Ohm, RG174A/U Coax							
0.100" dia.	31 dB / 100 ft.	16 W	12"	PE33674-12	\$36.85	\$34.27	\$31.69
			24"	PE33674-24	\$37.20	\$34.60	\$31.99
			36"	PE33674-36	\$37.45	\$34.83	\$32.21
			48"	PE33674-48	\$37.70	\$35.06	\$32.42
			60"	PE33674-60	\$37.90	\$35.25	\$32.59
		Any	PE33674-XX	See Website for Pricing			

See website for the following cable(s)

50 Ohm, RG178B/U Coax	PE33676
50 Ohm, RG188A/U Coax	PE3591
50 Ohm, RG188-DS Coax	PE34489
50 Ohm, RG196A/U Coax	PE3130
50 Ohm, RG316/U Coax	PE33680

Cable Dia.	Atten.*	Max Power*	Length	Model No.	1-24	25-49	50-99
50 Ohm, RG316-DS Coax							
0.114" dia.	30 dB / 100 ft.	160 W	12"	PE34487-12	\$36.85	\$34.27	\$31.69
			24"	PE34487-24	\$39.35	\$36.60	\$33.84
			36"	PE34487-36	\$41.80	\$38.87	\$35.95
			48"	PE34487-48	\$44.35	\$41.25	\$38.14
			60"	PE34487-60	\$46.75	\$43.48	\$40.21
		Any	PE34487-XX	See Website for Pricing			

SMB PLUG RIGHT ANGLE TO SMB PLUG RIGHT ANGLE



Cable Dia.	Atten.*	Max Power*	Length	Model No.	1-24	25-49	50-99
Standard Flexible Cable Assemblies							
See website for the following cable(s)							
50 Ohm, PE-B100 Coax				PE34465			
50 Ohm, RG58C/U Coax				PE33654			
50 Ohm, RG142B/U Coax				PE33656			

Cable Dia.	Atten.*	Max Power*	Length	Model No.	1-24	25-49	50-99
50 Ohm, RG174A/U Coax							
0.100" dia.	31 dB / 100 ft.	16 W	12"	PE3916-12	\$42.60	\$39.62	\$36.64
			24"	PE3916-24	\$43.00	\$39.99	\$36.98
			36"	PE3916-36	\$43.45	\$40.41	\$37.37
			48"	PE3916-48	\$43.85	\$40.78	\$37.71
			60"	PE3916-60	\$44.30	\$41.20	\$38.10
		Any	PE3916-XX	See Website for Pricing			

Cable Dia.	Atten.*	Max Power*	Length	Model No.	1-24	25-49	50-99
50 Ohm, RG178B/U Coax							
0.750" dia.	45 dB / 100 ft.	78 W	12"	PE33350-12	\$42.80	\$39.80	\$36.81
			24"	PE33350-24	\$43.50	\$40.46	\$37.41
			36"	PE33350-36	\$44.25	\$41.15	\$38.06
			48"	PE33350-48	\$44.95	\$41.80	\$38.66
			60"	PE33350-60	\$45.70	\$42.50	\$39.30
		Any	PE33350-XX	See Website for Pricing			

Cable Dia.	Atten.*	Max Power*	Length	Model No.	1-24	25-49	50-99
50 Ohm, RG188A/U Coax							
0.110" dia.	30 dB / 100 ft.	160 W	12"	PE3589-12	\$43.85	\$40.78	\$37.71
			24"	PE3589-24	\$45.55	\$42.36	\$39.17
			36"	PE3589-36	\$47.20	\$43.90	\$40.59
			48"	PE3589-48	\$48.90	\$45.48	\$42.05
			60"	PE3589-60	\$50.60	\$47.06	\$43.52
		Any	PE3589-XX	See Website for Pricing			

See website for the following cable(s)

50 Ohm, RG188-DS Coax	PE34463
50 Ohm, RG196A/U Coax	PE3590
50 Ohm, RG223/U Coax	PE33121
50 Ohm, RG316/U Coax	PE3917

SMB PLUG RIGHT ANGLE TO SMB PLUG RIGHT ANGLE



Cable Dia.	Atten.*	Max Power*	Length	Model No.	1-24	25-49	50-99
50 Ohm, RG316-DS Coax							
0.114" dia.	30 dB / 100 ft.	160 W	12"	PE33476-12	\$44.40	\$41.29	\$38.18
			24"	PE33476-24	\$46.70	\$43.43	\$40.16
			36"	PE33476-36	\$48.95	\$45.52	\$42.10
			48"	PE33476-48	\$51.25	\$47.66	\$44.08
			60"	PE33476-60	\$53.50	\$49.76	\$46.01
					Any	PE33476-XX	See Website for Pricing

SMB PLUG RIGHT ANGLE TO SMB JACK BULKHEAD

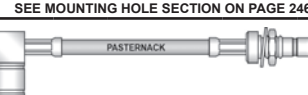

Cable Dia.	Atten.*	Max Power*	Length	Model No.	1-24	25-49	50-99
Standard Flexible Cable Assemblies							
See website for the following cable(s)							
50 Ohm, RG174A/U Coax				PE33261			
50 Ohm, RG178B/U Coax				PE34467			

Cable Dia.	Atten.*	Max Power*	Length	Model No.	1-24	25-49	50-99
50 Ohm, RG188A/U Coax							
0.110" dia.	30 dB / 100 ft.	160 W	12"	PE3594-12	\$43.30	\$40.27	\$37.24
			24"	PE3594-24	\$44.95	\$41.80	\$38.66
			36"	PE3594-36	\$46.65	\$43.38	\$40.12
			48"	PE3594-48	\$48.35	\$44.97	\$41.58
			60"	PE3594-60	\$50.05	\$46.55	\$43.04
		Any	PE3594-XX	See Website for Pricing			

Cable Dia.	Atten.*	Max Power*	Length	Model No.	1-24	25-49	50-99
50 Ohm, RG316/U Coax							
0.102" dia.	30 dB / 100 ft.	160 W	12"	PE33675-12	\$44.00	\$40.92	\$37.84
			24"	PE33675-24	\$46.35	\$43.11	\$39.86
			36"	PE33675-36	\$48.75	\$45.34	\$41.93
			48"	PE33675-48	\$51.15	\$47.57	\$43.99
			60"	PE33675-60	\$53.55	\$49.80	\$46.05
		Any	PE33675-XX	See Website for Pricing			

SMB PLUG TO BNC MALE



Cable Dia.	Atten.*	Max Power*	Length	Model No.	1-24	25-49	50-99
Standard Flexible Cable Assemblies							
See website for the following cable(s)							
50 Ohm, PE-B100 Coax				PE37536			

Cable Dia.	Atten.*	Max Power*	Length	Model No.	1-24	25-49	50-99
50 Ohm, RG58C/U Coax							
0.195" dia.	20 dB / 100 ft.	44 W	12"	PE3242-12	\$35.55	\$33.06	\$30.57
			24"	PE3242-24	\$35.90	\$33.39	\$30.87
			36"	PE3242-36	\$36.35	\$33.81	\$31.26
			48"	PE3242-48	\$36.75	\$34.18	\$31.61
			60"	PE3242-60	\$37.25	\$34.64	\$32.04
		Any	PE3242-XX	See Website for Pricing			

See website for the following cable(s)

50 Ohm, RG142B/U Coax	PE3349
-----------------------	--------

Cable Dia.	Atten.*	Max Power*	Length	Model No.	1-24	25-49	50-99
50 Ohm, RG174A/U Coax							
0.100" dia.	31 dB / 100 ft.	16 W	12"	PE3672-12	\$30.40	\$28.27	\$26.14
			24"	PE3672-24	\$30.80	\$28.64	\$26.49
			36"	PE3672-36	\$31.25	\$29.06	\$26.88
			48"	PE3672-48	\$31.65	\$29.43	\$27.22
			60"	PE3672-60	\$32.10	\$29.85	\$27.61
		Any	PE3672-XX	See Website for Pricing			

Cable Assemblies

*Coax Performance at 1 GHz
Notes: Cable assembly max frequency may be lower than connector or coax max frequency

Continued on Next Page

Continued from Previous Page

SMB PLUG TO BNC MALE



Cable Dia.	Atten.*	Max Power*	Length	Model No.	1-24	25-49	50-99
50 Ohm, RG188A/U Coax							
0.110" dia.	30 dB / 100 ft.	160 W	12"	PE3671-12	\$31.65	\$29.43	\$27.22
			24"	PE3671-24	\$33.30	\$30.97	\$28.64
			36"	PE3671-36	\$35.00	\$32.55	\$30.10
			48"	PE3671-48	\$36.70	\$34.13	\$31.56
			60"	PE3671-60	\$38.40	\$35.71	\$33.02
			Any	PE3671-XX	See Website for Pricing		
50 Ohm, RG223/U Coax							
0.216" dia.	16.5 dB / 100 ft.	53 W	12"	PE3236-12	\$35.55	\$33.06	\$30.57
			24"	PE3236-24	\$36.85	\$34.27	\$31.69
			36"	PE3236-36	\$38.25	\$35.57	\$32.90
			48"	PE3236-48	\$39.55	\$36.78	\$34.01
			60"	PE3236-60	\$41.00	\$38.13	\$35.26
			Any	PE3236-XX	See Website for Pricing		
50 Ohm, RG316/U Coax							
0.102" dia.	30 dB / 100 ft.	160 W	12"	PE3746-12	\$32.35	\$30.09	\$27.82
			24"	PE3746-24	\$34.75	\$32.32	\$29.89
			36"	PE3746-36	\$37.10	\$34.50	\$31.91
			48"	PE3746-48	\$39.50	\$36.74	\$33.97
			60"	PE3746-60	\$41.90	\$38.97	\$36.03
			Any	PE3746-XX	See Website for Pricing		
50 Ohm, RG316-DS Coax							
0.114" dia.	30 dB / 100 ft.	160 W	12"	PE3530-12	\$42.35	\$39.39	\$36.42
			24"	PE3530-24	\$44.80	\$41.66	\$38.53
			36"	PE3530-36	\$47.25	\$43.94	\$40.64
			48"	PE3530-48	\$49.80	\$46.31	\$42.83
			60"	PE3530-60	\$52.25	\$48.59	\$44.94
			Any	PE3530-XX	See Website for Pricing		
See website for the following cable(s)							
50 Ohm, PE-P195 Coax				PE37250			

FAKRA PLUG TO FAKRA PLUG

SEE FAKRA SPECIFICATION ON PAGE 243



Cable	Model No.
50 Ohm, RG316/U Coax	PE38755A
	PE38755B
	PE38755C
	PE38755D
	PE38755H
	PE38755I
	PE38755K
50 Ohm, PE-C100 Coax	PE38755Z
	PE38747A
	PE38747B
	PE38747C
	PE38747D
	PE38747H
	PE38747I
PE38747K	
PE38747Z	

FAKRA PLUG TO FAKRA JACK

SEE FAKRA SPECIFICATION ON PAGE 243



Cable	Model No.
Standard Flexible Cable Assemblies	
See website for the following cable(s)	
50 Ohm, RG174A/U Coax	PE38752A
	PE38752B
	PE38752C
	PE38752D
	PE38752H
	PE38752I
	PE38752K
50 Ohm, RG316/U Coax	PE38752Z
	PE38756A
	PE38756B
	PE38756C
	PE38756D
	PE38756H
	PE38756I
50 Ohm, PE-C100 Coax	PE38756K
	PE38756Z
	PE38748A
	PE38748B
	PE38748C
	PE38748D
	PE38748H
PE38748I	
PE38748K	
PE38748Z	

SSMB PLUG RIGHT ANGLE TO SSMB PLUG RIGHT ANGLE



Cable	Model No.
Standard Flexible Cable Assemblies	
See website for the following cable(s)	
50 Ohm, RG196A/U Coax	PE3134
50 Ohm, RG316/U Coax	PE3157

FAKRA PLUG TO FAKRA PLUG

SEE FAKRA SPECIFICATION ON PAGE 243



Cable	Model No.
Standard Flexible Cable Assemblies	
See website for the following cable(s)	
50 Ohm, RG174A/U Coax	PE38751A
	PE38751B
	PE38751C
	PE38751D
	PE38751H
	PE38751I
	PE38751K
	PE38751Z

FAKRA is a connector that complies with the German Automotive Standard (Fachkreis Automobil).

Cable Assemblies

*Coax Performance at 1 GHz
Notes: Cable assembly max frequency may be lower than connector or coax max frequency

FAKRA PLUG TO FAKRA JACK RIGHT ANGLE

SEE FAKRA SPECIFICATION ON PAGE 243



Cable Model No.

Standard Flexible Cable Assemblies

See website for the following cable(s)		
50 Ohm, RG174A/U Coax	PE38753A	1
	PE38753B	
	PE38753C	
	PE38753D	
	PE38753H	
	PE38753I	
	PE38753K	
50 Ohm, RG316/U Coax	PE38753Z	2
	PE38757A	
	PE38757B	
	PE38757C	
	PE38757D	
	PE38757H	
	PE38757I	
50 Ohm, PE-C100 Coax	PE38757K	3
	PE38757Z	
	PE38749A	
	PE38749B	
	PE38749C	
	PE38749D	
	PE38749H	
	PE38749I	
	PE38749K	
	PE38749Z	

FAKRA JACK TO FAKRA JACK

SEE FAKRA SPECIFICATION ON PAGE 243



Cable Model No.

Standard Flexible Cable Assemblies

See website for the following cable(s)		
50 Ohm, RG174A/U Coax	PE38750A	4
	PE38750B	
	PE38750C	
	PE38750D	
	PE38750H	
	PE38750I	
	PE38750K	
50 Ohm, RG316/U Coax	PE38750Z	5
	PE38754A	
	PE38754B	
	PE38754C	
	PE38754D	
	PE38754H	
	PE38754I	
50 Ohm, PE-C100 Coax	PE38754K	6
	PE38754Z	
	PE38746A	
	PE38746B	
	PE38746C	
	PE38746D	
	PE38746H	
PE38746I		
PE38746K		
PE38746Z		

GR874 TO GR874



Cable Model No.

Standard Flexible Cable Assemblies

See website for the following cable(s)		
50 Ohm, RG58C/U Coax	PE3211	7
50 Ohm, RG214/U Coax	PE3158	8

GR874 TO BNC MALE



Cable Model No.

Standard Flexible Cable Assemblies

See website for the following cable(s)		
50 Ohm, RG214/U Coax	PE3145	9
50 Ohm, RG223/U Coax	PE3182	10

BNC MALE TO BNC MALE



Cable Dia. Atten.* Max Power* Length Model No. 1-24 25-49 50-99

Standard Flexible Cable Assemblies

See website for the following cable(s)								
52 Ohm, RG8A/U Coax	PE3807	11						
50 Ohm, RG8X Coax	PE3264	12						
53.5 Ohm, RG55B/U Coax								
0.206" dia.	16.5 dB / 100 ft.	53 W	12"	PE3583-12	\$21.85	\$20.32	\$18.79	13
			24"	PE3583-24	\$22.60	\$21.02	\$19.44	
			36"	PE3583-36	\$23.90	\$22.23	\$20.55	
			48"	PE3583-48	\$25.60	\$23.81	\$22.02	
			60"	PE3583-60	\$27.30	\$25.39	\$23.48	
			Any	PE3583-XX	See Website for Pricing			
50 Ohm, RG58C/U Coax								
0.195" dia.	20 dB / 100 ft.	44 W	12"	PE3067-12	\$23.35	\$21.72	\$20.08	14
			24"	PE3067-24	\$23.90	\$22.23	\$20.55	
			36"	PE3067-36	\$24.60	\$22.88	\$21.16	
			48"	PE3067-48	\$25.20	\$23.44	\$21.67	
			60"	PE3067-60	\$25.85	\$24.04	\$22.23	
			Any	PE3067-XX	See Website for Pricing			
See website for the following cable(s)								
50 Ohm, RG58-P Coax	PE3999	15						
93 Ohm, RG62A/U Coax								
0.242" dia.	8.5 dB / 100 ft.	77 W	12"	PE3081-12	\$20.50	\$19.07	\$17.63	16
			24"	PE3081-24	\$21.30	\$19.81	\$18.32	
			36"	PE3081-36	\$22.30	\$20.74	\$19.18	
			48"	PE3081-48	\$23.35	\$21.72	\$20.08	
			60"	PE3081-60	\$24.40	\$22.69	\$20.98	
			Any	PE3081-XX	See Website for Pricing			
50 Ohm, RG142B/U Coax								
0.195" dia.	13 dB / 100 ft.	650 W	12"	PE3495-12	\$22.90	\$21.30	\$19.69	17
			24"	PE3495-24	\$27.05	\$25.16	\$23.26	
			36"	PE3495-36	\$31.20	\$29.02	\$26.83	
			48"	PE3495-48	\$35.30	\$32.83	\$30.36	
			60"	PE3495-60	\$39.45	\$36.69	\$33.93	
			Any	PE3495-XX	See Website for Pricing			

Cable Assemblies

*Coax Performance at 1 GHz
Notes: Cable assembly max frequency may be lower than connector or coax max frequency

Continued on Next Page

Continued from Previous Page

BNC MALE TO BNC MALE							
							
Cable Dia.	Atten.*	Max Power*	Length	Model No.	1-24	25-49	50-99
50 Ohm, RG174A/U Coax							
0.100" dia.	31 dB / 100 ft.	16 W	12"	PE3538-12	\$28.85	\$26.83	\$24.81
			24"	PE3538-24	\$29.30	\$27.25	\$25.20
			36"	PE3538-36	\$29.70	\$27.62	\$25.54
			48"	PE3538-48	\$30.15	\$28.04	\$25.93
			60"	PE3538-60	\$30.55	\$28.41	\$26.27
			Any	PE3538-XX	See Website for Pricing		
See website for the following cable(s)							
50 Ohm, RG178B/U Coax				PE33130			
95 Ohm, RG180B/U Twinax				PE33574			
50 Ohm, RG188A/U Coax							
0.110" dia.	30 dB / 100 ft.	160 W	12"	PE3470-12	\$30.10	\$27.99	\$25.89
			24"	PE3470-24	\$31.80	\$29.57	\$27.35
			36"	PE3470-36	\$33.50	\$31.16	\$28.81
			48"	PE3470-48	\$35.20	\$32.74	\$30.27
			60"	PE3470-60	\$36.85	\$34.27	\$31.69
			Any	PE3470-XX	See Website for Pricing		
See website for the following cable(s)							
50 Ohm, RG188-DS Coax				PE34388			
50 Ohm, RG213/U Coax							
0.405" dia.	9 dB / 100 ft.	190 W	12"	PE3749-12	\$50.60	\$47.06	\$43.52
			24"	PE3749-24	\$51.90	\$48.27	\$44.63
			36"	PE3749-36	\$53.55	\$49.80	\$46.05
			48"	PE3749-48	\$55.05	\$51.20	\$47.34
			60"	PE3749-60	\$56.45	\$52.50	\$48.55
			Any	PE3749-XX	See Website for Pricing		
50 Ohm, RG214/U Coax							
0.425" dia.	9 dB / 100 ft.	190 W	12"	PE3906-12	\$55.80	\$51.89	\$47.99
			24"	PE3906-24	\$61.55	\$57.24	\$52.93
			36"	PE3906-36	\$67.05	\$62.36	\$57.66
			48"	PE3906-48	\$72.25	\$67.19	\$62.14
			60"	PE3906-60	\$77.65	\$72.21	\$66.78
			Any	PE3906-XX	See Website for Pricing		
50 Ohm, RG223/U Coax							
0.216" dia.	16.5 dB / 100 ft.	53 W	12"	PE3087-12	\$21.85	\$20.32	\$18.79
			24"	PE3087-24	\$23.20	\$21.58	\$19.95
			36"	PE3087-36	\$25.40	\$23.62	\$21.84
			48"	PE3087-48	\$27.60	\$25.67	\$23.74
			60"	PE3087-60	\$29.80	\$27.71	\$25.63
			Any	PE3087-XX	See Website for Pricing		
50 Ohm, RG316/U Coax							
0.102" dia.	30 dB / 100 ft.	160 W	12"	PE3584-12	\$30.80	\$28.64	\$26.49
			24"	PE3584-24	\$32.55	\$30.27	\$27.99
			36"	PE3584-36	\$33.85	\$31.48	\$29.11
			48"	PE3584-48	\$35.25	\$32.78	\$30.32
			60"	PE3584-60	\$36.85	\$34.27	\$31.69
			Any	PE3584-XX	See Website for Pricing		
See website for the following cable(s)							
50 Ohm, RG316-DS Coax				PE3163			
50 Ohm, RG400/U Coax							
0.195" dia.	13 dB / 100 ft.	650 W	12"	PE3582-12	\$28.60	\$26.60	\$24.60
			24"	PE3582-24	\$34.00	\$31.62	\$29.24
			36"	PE3582-36	\$38.85	\$36.13	\$33.41
			48"	PE3582-48	\$42.75	\$39.76	\$36.77
			60"	PE3582-60	\$46.65	\$43.38	\$40.12
			Any	PE3582-XX	See Website for Pricing		
See website for the following cable(s)							
50 Ohm, PE-C195 Coax				PE36066			
50 Ohm, PE-C240 Coax				PE36219			

BNC MALE TO BNC MALE							
							
Cable Dia.	Atten.*	Max Power*	Length	Model No.	1-24	25-49	50-99
75 Ohm, RG59B/U Coax							
0.242" dia.	11.5 dB / 100 ft.	77 W	12"	PE3075-12	\$19.95	\$18.55	\$17.16
			24"	PE3075-24	\$20.65	\$19.20	\$17.76
			36"	PE3075-36	\$21.40	\$19.90	\$18.40
			48"	PE3075-48	\$22.10	\$20.55	\$19.01
			60"	PE3075-60	\$22.85	\$21.25	\$19.65
			Any	PE3075-XX	See Website for Pricing		
75 Ohm, RG179B/U Coax							
0.100" dia.	25 dB / 100 ft.	200 W	12"	PE3705-12	\$30.30	\$28.18	\$26.06
			24"	PE3705-24	\$32.20	\$29.95	\$27.69
			36"	PE3705-36	\$33.85	\$31.48	\$29.11
			48"	PE3705-48	\$35.25	\$32.78	\$30.32
			60"	PE3705-60	\$36.85	\$34.27	\$31.69
			Any	PE3705-XX	See Website for Pricing		
See website for the following cable(s)							
75 Ohm, RG302/U Coax				PE33123			
50 Ohm, PE-P195 Coax				PE34035			
Standard Formable Cable Assemblies							
See website for the following cable(s)							
50 Ohm, PE-SR402FL Coax				PE3462			
Standard Semirigid Cable Assemblies							
See website for the following cable(s)							
50 Ohm, PE-SR402AL Coax				PE34164			
50 Ohm, RG402/U Coax				PE3445			
50 Ohm, RG405/U Coax				PE3678			

BNC MALE TO BNC MALE RIGHT ANGLE							
							
Cable Dia.	Atten.*	Max Power*	Length	Model No.	1-24	25-49	50-99
Standard Flexible Cable Assemblies							
50 Ohm, RG58C/U Coax							
0.195" dia.	20 dB / 100 ft.	44 W	12"	PE3020-12	\$36.95	\$34.36	\$31.78
			24"	PE3020-24	\$37.60	\$34.97	\$32.34
			36"	PE3020-36	\$38.15	\$35.48	\$32.81
			48"	PE3020-48	\$38.70	\$35.99	\$33.28
			60"	PE3020-60	\$39.45	\$36.69	\$33.93
			Any	PE3020-XX	See Website for Pricing		
See website for the following cable(s)							
50 Ohm, RG142B/U Coax				PE3082			
50 Ohm, RG174A/U Coax							
0.100" dia.	31 dB / 100 ft.	16 W	12"	PE3460-12	\$39.90	\$37.11	\$34.31
			24"	PE3460-24	\$40.35	\$37.53	\$34.70
			36"	PE3460-36	\$40.75	\$37.90	\$35.05
			48"	PE3460-48	\$41.20	\$38.32	\$35.43
			60"	PE3460-60	\$41.60	\$38.69	\$35.78
			Any	PE3460-XX	See Website for Pricing		
See website for the following cable(s)							
50 Ohm, RG188A/U Coax				PE3113			
50 Ohm, RG188-DS Coax				PE3330			
50 Ohm, RG213/U Coax				PE3355			
50 Ohm, RG214/U Coax				PE3325			
50 Ohm, RG223/U Coax							
0.216" dia.	16.5 dB / 100 ft.	53 W	12"	PE3689-12	\$32.75	\$30.46	\$28.17
			24"	PE3689-24	\$34.30	\$31.90	\$29.50
			36"	PE3689-36	\$36.55	\$33.99	\$31.43
			48"	PE3689-48	\$38.75	\$36.04	\$33.33
			60"	PE3689-60	\$40.95	\$38.08	\$35.22
			Any	PE3689-XX	See Website for Pricing		

Cable Assemblies

*Coax Performance at 1 GHz
Notes: Cable assembly max frequency may be lower than connector or coax max frequency

Continued on Next Page

Continued from Previous Page

BNC MALE TO BNC MALE RIGHT ANGLE



Cable Dia.	Atten.*	Max Power*	Length	Model No.	1-24	25-49	50-99
See website for the following cable(s)							
50 Ohm, RG316/U Coax				PE3332			
50 Ohm, RG316-DS Coax				PE3358			
50 Ohm, RG400/U Coax				PE3116			
75 Ohm, RG59B/U Coax				PE3508			
75 Ohm, RG179B/U Coax				PE3054			
Standard Formable Cable Assemblies							
See website for the following cable(s)							
50 Ohm, PE-SR402FL Coax				PE35580			
Standard Semirigid Cable Assemblies							
See website for the following cable(s)							
50 Ohm, RG402/U Coax				PE39108			

BNC MALE TO BNC FEMALE



Cable Dia.	Atten.*	Max Power*	Length	Model No.	1-24	25-49	50-99
Standard Flexible Cable Assemblies							
See website for the following cable(s)							
52 Ohm, RG8A/U Coax				PE3360			
53.5 Ohm, RG55B/U Coax				PE3375			
50 Ohm, RG58C/U Coax							
0.195" dia.	20 dB / 100 ft.	44 W	12"	PE3047-12	\$25.75	\$23.95	\$22.15
			24"	PE3047-24	\$26.30	\$24.46	\$22.62
			36"	PE3047-36	\$26.85	\$24.97	\$23.09
			48"	PE3047-48	\$27.40	\$25.48	\$23.56
			60"	PE3047-60	\$27.95	\$25.99	\$24.04
Any	PE3047-XX	See Website for Pricing					
See website for the following cable(s)							
50 Ohm, RG142B/U Coax				PE3777			
50 Ohm, RG174A/U Coax							
0.100" dia.	31 dB / 100 ft.	16 W	12"	PE3674-12	\$32.35	\$30.09	\$27.82
			24"	PE3674-24	\$32.80	\$30.50	\$28.21
			36"	PE3674-36	\$33.20	\$30.88	\$28.55
			48"	PE3674-48	\$33.65	\$31.29	\$28.94
			60"	PE3674-60	\$34.05	\$31.67	\$29.28
Any	PE3674-XX	See Website for Pricing					
See website for the following cable(s)							
50 Ohm, RG213/U Coax				PE3949			
50 Ohm, RG214/U Coax				PE3371			
50 Ohm, RG223/U Coax				PE3606			
50 Ohm, RG316/U Coax				PE3079			
50 Ohm, RG400/U Coax				PE3627			
50 Ohm, PE-C195 Coax				PE38344			
75 Ohm, RG59B/U Coax				PE3792			
75 Ohm, RG179B/U Coax				PE3354			

Radio frequencies and microwaves all travel at the Speed of Light which equals 300,000 kilometers per second or 186,000 miles per second or 173 astronomical units per day.

BNC MALE TO BNC FEMALE BULKHEAD

SEE MOUNTING HOLE SECTION ON PAGE 246



Cable Dia.	Atten.*	Max Power*	Length	Model No.	1-24	25-49	50-99
Standard Flexible Cable Assemblies							
50 Ohm, RG58C/U Coax							
0.195" dia.	20 dB / 100 ft.	44 W	12"	PE3649-12	\$29.65	\$27.57	\$25.50
			24"	PE3649-24	\$30.20	\$28.09	\$25.97
			36"	PE3649-36	\$30.75	\$28.60	\$26.45
			48"	PE3649-48	\$31.25	\$29.06	\$26.88
			60"	PE3649-60	\$31.80	\$29.57	\$27.35
Any	PE3649-XX	See Website for Pricing					
See website for the following cable(s)							
50 Ohm, RG142B/U Coax				PE3436			
50 Ohm, RG174A/U Coax							
0.100" dia.	31 dB / 100 ft.	16 W	12"	PE3431-12	\$35.55	\$33.06	\$30.57
			24"	PE3431-24	\$35.80	\$33.29	\$30.79
			36"	PE3431-36	\$36.05	\$33.53	\$31.00
			48"	PE3431-48	\$36.30	\$33.76	\$31.22
			60"	PE3431-60	\$36.60	\$34.04	\$31.48
Any	PE3431-XX	See Website for Pricing					
See website for the following cable(s)							
50 Ohm, RG188A/U Coax				PE3442			
50 Ohm, RG188-DS Coax				PE3446			
50 Ohm, RG223/U Coax							
0.216" dia.	16.5 dB / 100 ft.	53 W	12"	PE3557-12	\$31.40	\$29.20	\$27.00
			24"	PE3557-24	\$32.75	\$30.46	\$28.17
			36"	PE3557-36	\$34.55	\$32.13	\$29.71
			48"	PE3557-48	\$36.75	\$34.18	\$31.61
			60"	PE3557-60	\$39.00	\$36.27	\$33.54
Any	PE3557-XX	See Website for Pricing					
50 Ohm, RG316/U Coax							
0.102" dia.	30 dB / 100 ft.	160 W	12"	PE3854-12	\$35.55	\$33.06	\$30.57
			24"	PE3854-24	\$37.55	\$34.92	\$32.29
			36"	PE3854-36	\$39.95	\$37.15	\$34.36
			48"	PE3854-48	\$42.35	\$39.39	\$36.42
			60"	PE3854-60	\$44.75	\$41.62	\$38.49
Any	PE3854-XX	See Website for Pricing					
See website for the following cable(s)							
50 Ohm, RG316-DS Coax				PE3454			
50 Ohm, RG400/U Coax				PE3423			
75 Ohm, RG59B/U Coax				PE3103			
75 Ohm, RG179B/U Coax				PE3413			

BNC MALE RIGHT ANGLE TO BNC MALE RIGHT ANGLE



Cable Dia.	Atten.*	Max Power*	Length	Model No.	1-24	25-49	50-99
Standard Flexible Cable Assemblies							
See website for the following cable(s)							
53.5 Ohm, RG55B/U Coax				PE38506			
50 Ohm, RG58C/U Coax							
0.195" dia.	20 dB / 100 ft.	44 W	12"	PE3025-12	\$50.60	\$47.06	\$43.52
			24"	PE3025-24	\$51.15	\$47.57	\$43.99
			36"	PE3025-36	\$51.75	\$48.13	\$44.51
			48"	PE3025-48	\$52.45	\$48.78	\$45.11
			60"	PE3025-60	\$53.00	\$49.29	\$45.58
Any	PE3025-XX	See Website for Pricing					

Continued on Next Page

Cable Assemblies

*Coax Performance at 1 GHz
Notes: Cable assembly max frequency may be lower than connector or coax max frequency

Continued from Previous Page

BNC MALE RIGHT ANGLE TO BNC MALE RIGHT ANGLE



Cable Dia.	Atten.*	Max Power*	Length	Model No.	1-24	25-49	50-99
50 Ohm, RG142B/U Coax							
0.195" dia.	13 dB / 100 ft.	650 W	12"	PE3044-12	\$49.60	\$46.13	\$42.66
			24"	PE3044-24	\$53.75	\$49.99	\$46.23
			36"	PE3044-36	\$57.85	\$53.80	\$49.75
			48"	PE3044-48	\$62.00	\$57.66	\$53.32
			60"	PE3044-60	\$66.15	\$61.52	\$56.89
		Any	PE3044-XX	See Website for Pricing			
50 Ohm, RG174A/U Coax							
0.100" dia.	31 dB / 100 ft.	16 W	12"	PE3373-12	\$50.95	\$47.38	\$43.82
			24"	PE3373-24	\$51.35	\$47.76	\$44.16
			36"	PE3373-36	\$51.80	\$48.17	\$44.55
			48"	PE3373-48	\$52.25	\$48.59	\$44.94
			60"	PE3373-60	\$52.65	\$48.96	\$45.28
		Any	PE3373-XX	See Website for Pricing			
See website for the following cable(s)							
50 Ohm, RG188A/U Coax				PE3351			
50 Ohm, RG214/U Coax				PE3370			
50 Ohm, RG223/U Coax				PE3816			
50 Ohm, RG316/U Coax				PE3842			
50 Ohm, RG316-DS Coax							
0.114" dia.	30 dB / 100 ft.	160 W	12"	PE3389-12	\$52.80	\$49.10	\$45.41
			24"	PE3389-24	\$55.05	\$51.20	\$47.34
			36"	PE3389-36	\$57.30	\$53.29	\$49.28
			48"	PE3389-48	\$59.60	\$55.43	\$51.26
			60"	PE3389-60	\$61.85	\$57.52	\$53.19
		Any	PE3389-XX	See Website for Pricing			
See website for the following cable(s)							
50 Ohm, RG400/U Coax				PE3458			
75 Ohm, RG59B/U Coax							
0.242" dia.	11.5 dB / 100 ft.	77 W	12"	PE3935-12	\$50.45	\$46.92	\$43.39
			24"	PE3935-24	\$51.20	\$47.62	\$44.03
			36"	PE3935-36	\$51.90	\$48.27	\$44.63
			48"	PE3935-48	\$52.65	\$48.96	\$45.28
			60"	PE3935-60	\$53.40	\$49.66	\$45.92
		Any	PE3935-XX	See Website for Pricing			
See website for the following cable(s)							
75 Ohm, RG179B/U Coax				PE3366			
50 Ohm, PE-P195 Coax				PE37640			

BNC FEMALE TO BNC FEMALE



Cable Dia.	Atten.*	Max Power*	Length	Model No.	1-24	25-49	50-99
Standard Flexible Cable Assemblies							
50 Ohm, RG58C/U Coax							
0.195" dia.	20 dB / 100 ft.	44 W	12"	PE3052-12	\$27.10	\$25.20	\$23.31
			24"	PE3052-24	\$27.65	\$25.71	\$23.78
			36"	PE3052-36	\$28.15	\$26.18	\$24.21
			48"	PE3052-48	\$28.70	\$26.69	\$24.68
			60"	PE3052-60	\$29.25	\$27.20	\$25.16
		Any	PE3052-XX	See Website for Pricing			
50 Ohm, RG174A/U Coax							
0.100" dia.	31 dB / 100 ft.	16 W	12"	PE3604-12	\$35.85	\$33.34	\$30.83
			24"	PE3604-24	\$36.30	\$33.76	\$31.22
			36"	PE3604-36	\$36.70	\$34.13	\$31.56
			48"	PE3604-48	\$37.15	\$34.55	\$31.95
			60"	PE3604-60	\$37.55	\$34.92	\$32.29
		Any	PE3604-XX	See Website for Pricing			

BNC FEMALE TO BNC FEMALE



Cable Dia.	Atten.*	Max Power*	Length	Model No.	1-24	25-49	50-99
See website for the following cable(s)							
50 Ohm, RG223/U Coax				PE3364			
50 Ohm, RG316/U Coax							
0.102" dia.	30 dB / 100 ft.	160 W	12"	PE3505-12	\$37.80	\$35.15	\$32.51
			24"	PE3505-24	\$40.20	\$37.39	\$34.57
			36"	PE3505-36	\$42.60	\$39.62	\$36.64
			48"	PE3505-48	\$45.00	\$41.85	\$38.70
			60"	PE3505-60	\$47.40	\$44.08	\$40.76
		Any	PE3505-XX	See Website for Pricing			

BNC MALE TO BANANA PLUG



Cable Dia.	Atten.*	Max Power*	Length	Model No.	1-24	25-49	50-99
Standard Flexible Cable Assemblies							
See website for the following cable(s)							
50 Ohm, RG58C/U Coax				PE3000			
50 Ohm, RG58C/U Coax							
0.195" dia.	20 dB / 100 ft.	44 W	12"	PE33552-12	\$32.70	\$30.41	\$28.12
			24"	PE33552-24	\$33.25	\$30.92	\$28.60
			36"	PE33552-36	\$33.75	\$31.39	\$29.03
			48"	PE33552-48	\$34.30	\$31.90	\$29.50
			60"	PE33552-60	\$34.85	\$32.41	\$29.97
		Any	PE33552-XX	See Website for Pricing			
See website for the following cable(s)							
50 Ohm, RG142B/U Coax				PE33440			
50 Ohm, RG174A/U Coax				PE34593			
50 Ohm, RG223/U Coax				PE33442			
50 Ohm, RG316/U Coax				PE34597			
75 Ohm, RG59B/U Coax				PE33554			

BNC MALE TO ALLIGATOR CLIP



Cable Dia.	Atten.*	Max Power*	Length	Model No.	1-24	25-49	50-99
Standard Flexible Cable Assemblies							
See website for the following cable(s)							
53.5 Ohm, RG55B/U Coax				PE34536			
50 Ohm, RG58C/U Coax							
0.195" dia.	20 dB / 100 ft.	44 W	12"	PE3501-12	\$29.20	\$27.16	\$25.11
			24"	PE3501-24	\$29.70	\$27.62	\$25.54
			36"	PE3501-36	\$30.45	\$28.32	\$26.19
			48"	PE3501-48	\$31.00	\$28.83	\$26.66
			60"	PE3501-60	\$31.55	\$29.34	\$27.13
		Any	PE3501-XX	See Website for Pricing			
See website for the following cable(s)							
50 Ohm, RG223/U Coax				PE3346			
50 Ohm, RG400/U Coax				PE34534			

BNC MALE TO MINI ALLIGATOR CLIP



Cable	Model No.
Standard Flexible Cable Assemblies	
See website for the following cable(s)	
50 Ohm, RG58C/U Coax	PE33546

Cable Assemblies

*Coax Performance at 1 GHz
Notes: Cable assembly max frequency may be lower than connector or coax max frequency



Free Freight Available via UPS Ground to USA & Canada



Real-Time Stock Levels & Pricing On Our Website



Toll-Free Technical Support (866) 727-8376



Same-Day Shipping, Even Custom Cable Assemblies

Cable Assemblies

*Coax Performance at 1 GHz
Notes: Cable assembly max frequency may be lower than connector or coax max frequency

BNC MALE TO TIP PLUG



Cable	Model No.
Standard Flexible Cable Assemblies	
50 Ohm, RG58C/U Coax	
50 Ohm, RG58C/U Coax	PE33009

1

BNC MALE TO MINI BANANA PLUG



Cable	Model No.
Standard Flexible Cable Assemblies	
See website for the following cable(s)	
50 Ohm, RG58C/U Coax	PE33557

2

BNC MALE TO HOOK



Cable Dia.	Atten.*	Max Power*	Length	Model No.	1-24	25-49	50-99
Standard Flexible Cable Assemblies							
50 Ohm, RG58C/U Coax							
0.195" dia.	20 dB / 100 ft.	44 W	12"	PE33561-12	\$32.70	\$30.41	\$28.12
			24"	PE33561-24	\$33.25	\$30.92	\$28.60
			36"	PE33561-36	\$33.75	\$31.39	\$29.03
			48"	PE33561-48	\$34.30	\$31.90	\$29.50
			60"	PE33561-60	\$34.85	\$32.41	\$29.97
Any	PE33561-XX	See Website for Pricing					
See website for the following cable(s)							
75 Ohm, RG59B/U Coax	PE33563						

3

BNC MALE TO UNTERMINATED LEAD



Cable Dia.	Atten.*	Max Power*	Length	Model No.	1-24	25-49	50-99
Standard Flexible Cable Assemblies							
50 Ohm, RG58C/U Coax							
0.195" dia.	20 dB / 100 ft.	44 W	12"	PE33565-12	\$27.90	\$25.95	\$23.99
			24"	PE33565-24	\$28.40	\$26.41	\$24.42
			36"	PE33565-36	\$28.95	\$26.92	\$24.90
			48"	PE33565-48	\$29.50	\$27.44	\$25.37
			60"	PE33565-60	\$30.05	\$27.95	\$25.84
Any	PE33565-XX	See Website for Pricing					
See website for the following cable(s)							
75 Ohm, RG59B/U Coax	PE33567						

5

BNC MALE TO NMO MOUNT CONNECTOR

NMO MOUNT REQUIRES 3/4" HOLE, 1 1/8"-18 THREAD AND INSTALLS FROM ABOVE.



Cable	Model No.
Standard Flexible Cable Assemblies	
See website for the following cable(s)	
50 Ohm, RG58C/U Coax	PE37844

7

BNC FEMALE TO NMO MOUNT CONNECTOR

NMO MOUNT REQUIRES 3/4" HOLE, 1 1/8"-18 THREAD AND INSTALLS FROM ABOVE.



Cable	Model No.
Standard Flexible Cable Assemblies	
See website for the following cable(s)	
50 Ohm, RG58C/U Coax	PE37845

8

MHV MALE TO MHV MALE



Cable Dia.	Atten.*	Max Power*	Length	Model No.	1-24	25-49	50-99
Standard Flexible Cable Assemblies							
See website for the following cable(s)							
52 Ohm, RG8A/U Coax				PE3098			
50 Ohm, RG58C/U Coax							
0.195" dia.	20 dB / 100 ft.	44 W	12"	PE3516-12	\$53.85	\$50.08	\$46.31
			24"	PE3516-24	\$54.40	\$50.59	\$46.78
			36"	PE3516-36	\$54.90	\$51.06	\$47.21
			48"	PE3516-48	\$55.45	\$51.57	\$47.69
			60"	PE3516-60	\$56.00	\$52.08	\$48.16
Any	PE3516-XX	See Website for Pricing					

9

MHV MALE TO SHV PLUG



Cable Dia.	Atten.*	Max Power*	Length	Model No.	1-24	25-49	50-99
Standard Flexible Cable Assemblies							
See website for the following cable(s)							
50 Ohm, RG142B/U Coax				PE3914			
50 Ohm, RG174A/U Coax							
0.100" dia.	31 dB / 100 ft.	16 W	12"	PE34427-12	\$62.20	\$57.85	\$53.49
			24"	PE34427-24	\$62.70	\$58.31	\$53.92
			36"	PE34427-36	\$63.00	\$58.59	\$54.18
			48"	PE34427-48	\$63.45	\$59.01	\$54.57
			60"	PE34427-60	\$63.90	\$59.43	\$54.95
Any	PE34427-XX	See Website for Pricing					

10

MHV MALE TO MHV MALE

Cable Dia.	Atten.*	Max Power*	Length	Model No.	1-24	25-49	50-99
Standard Flexible Cable Assemblies							
See website for the following cable(s)							
50 Ohm, RG214/U Coax				PE3735			
50 Ohm, RG223/U Coax							
0.216" dia.	16.5 dB / 100 ft.	53 W	12"	PE3694-12	\$41.50	\$38.60	\$35.69
			24"	PE3694-24	\$43.70	\$40.64	\$37.58
			36"	PE3694-36	\$45.95	\$42.73	\$39.52
			48"	PE3694-48	\$48.15	\$44.78	\$41.41
			60"	PE3694-60	\$50.35	\$46.83	\$43.30
Any	PE3694-XX	See Website for Pricing					

11

MHV MALE TO MHV MALE

Cable Dia.	Atten.*	Max Power*	Length	Model No.	1-24	25-49	50-99
Standard Flexible Cable Assemblies							
See website for the following cable(s)							
50 Ohm, RG316/U Coax				PE34433			
50 Ohm, RG393/U Coax				PE3577			
50 Ohm, RG400/U Coax				PE34425			

12

MHV MALE TO MHV MALE

Cable	Model No.	1-24	25-49	50-99
Standard Flexible Cable Assemblies				
See website for the following cable(s)				
52 Ohm, RG8A/U Coax	PE3365			
50 Ohm, RG58C/U Coax	PE3950			
50 Ohm, RG142B/U Coax	PE3085			
50 Ohm, RG174A/U Coax	PE34419			
50 Ohm, RG223/U Coax	PE34411			

13

SHV PLUG TO SHV PLUG							
							
Cable Dia.	Atten.*	Max Power*	Length	Model No.	1-24	25-49	50-99
Standard Flexible Cable Assemblies							
52 Ohm, RG8A/U Coax							
0.405" dia.	9 dB / 100 ft.	190 W	12"	PE33068-12	\$95.55	\$88.86	\$82.17
			24"	PE33068-24	\$96.65	\$89.88	\$83.12
			36"	PE33068-36	\$97.65	\$90.81	\$83.98
			48"	PE33068-48	\$98.80	\$91.88	\$84.97
			60"	PE33068-60	\$99.75	\$92.77	\$85.79
Any	PE33068-XX	See Website for Pricing					
50 Ohm, RG58C/U Coax							
0.195" dia.	20 dB / 100 ft.	44 W	12"	PE3815-12	\$81.95	\$76.21	\$70.48
			24"	PE3815-24	\$82.35	\$76.59	\$70.82
			36"	PE3815-36	\$82.85	\$77.05	\$71.25
			48"	PE3815-48	\$83.20	\$77.38	\$71.55
			60"	PE3815-60	\$83.65	\$77.79	\$71.94
Any	PE3815-XX	See Website for Pricing					
See website for the following cable(s)							
50 Ohm, RG141A/U Coax				PE34428			
50 Ohm, RG142B/U Coax				PE3843			
50 Ohm, RG174A/U Coax				PE33706			
50 Ohm, RG188A/U Coax				PE34430			
50 Ohm, RG213/U Coax				PE35384			
50 Ohm, RG214/U Coax							
0.425" dia.	9 dB / 100 ft.	190 W	12"	PE3117-12	\$102.45	\$95.28	\$88.11
			24"	PE3117-24	\$106.15	\$98.72	\$91.29
			36"	PE3117-36	\$109.90	\$102.21	\$94.51
			48"	PE3117-48	\$113.55	\$105.60	\$97.65
			60"	PE3117-60	\$117.30	\$109.09	\$100.88
Any	PE3117-XX	See Website for Pricing					
50 Ohm, RG223/U Coax							
0.216" dia.	16.5 dB / 100 ft.	53 W	12"	PE3992-12	\$81.95	\$76.21	\$70.48
			24"	PE3992-24	\$83.35	\$77.52	\$71.68
			36"	PE3992-36	\$84.65	\$78.72	\$72.80
			48"	PE3992-48	\$86.00	\$79.98	\$73.96
			60"	PE3992-60	\$87.40	\$81.28	\$75.16
Any	PE3992-XX	See Website for Pricing					
See website for the following cable(s)							
50 Ohm, RG225/U Coax				PE34421			
50 Ohm, RG316/U Coax				PE34432			
50 Ohm, RG393/U Coax				PE3338			
50 Ohm, RG400/U Coax				PE34424			
50 Ohm, PE-P195 Coax				PE39229			

C MALE TO C MALE							
							
Cable	Model No.						
Standard Flexible Cable Assemblies							
See website for the following cable(s)							
52 Ohm, RG8A/U Coax				PE33316			
50 Ohm, RG58C/U Coax				PE3457			
50 Ohm, RG142B/U Coax				PE3518			
50 Ohm, RG214/U Coax				PE3605			
50 Ohm, RG217/U Coax				PE34437			
50 Ohm, RG223/U Coax				PE3343			
50 Ohm, RG393/U Coax				PE3120			

75 OHM N MALE TO 75 OHM N MALE							
							
Cable Dia.	Atten.*	Max Power*	Length	Model No.	1-24	25-49	50-99
Standard Flexible Cable Assemblies							
75 Ohm, RG6A/U Coax							
0.332" dia.	11 dB / 100 ft.	125 W	12"	PE3612-12	\$44.65	\$41.52	\$38.40
			24"	PE3612-24	\$46.10	\$42.87	\$39.65
			36"	PE3612-36	\$47.55	\$44.22	\$40.89
			48"	PE3612-48	\$49.00	\$45.57	\$42.14
			60"	PE3612-60	\$50.45	\$46.92	\$43.39
Any	PE3612-XX	See Website for Pricing					
See website for the following cable(s)							
75 Ohm, RG11A/U Coax				PE3616			
75 Ohm, RG59B/U Coax							
0.242" dia.	11.5 dB / 100 ft.	77 W	12"	PE3528-12	\$45.05	\$41.90	\$38.74
			24"	PE3528-24	\$45.40	\$42.22	\$39.04
			36"	PE3528-36	\$45.90	\$42.69	\$39.47
			48"	PE3528-48	\$46.35	\$43.11	\$39.86
			60"	PE3528-60	\$46.85	\$43.57	\$40.29
Any	PE3528-XX	See Website for Pricing					
See website for the following cable(s)							
75 Ohm, RG179B/U Coax				PE3307			
75 Ohm, RG187A/U Coax				PE3581			
75 Ohm, RG216/U Coax				PE3618			

75 OHM N MALE TO 75 OHM BNC MALE							
							
Cable	Model No.						
Standard Flexible Cable Assemblies							
See website for the following cable(s)							
75 Ohm, RG6A/U Coax				PE3341			
75 Ohm, RG11A/U Coax				PE3396			
75 Ohm, RG59B/U Coax				PE33605			
75 Ohm, RG179B/U Coax				PE3398			
75 Ohm, RG216/U Coax				PE3404			

75 OHM TNC MALE TO 75 OHM TNC MALE							
							
Cable	Model No.						
Standard Flexible Cable Assemblies							
See website for the following cable(s)							
75 Ohm, RG6A/U Coax				PE35348			
75 Ohm, RG11A/U Coax				PE35352			
75 Ohm, RG59B/U Coax				PE35356			

75 OHM TNC MALE TO 75 OHM BNC MALE							
							
Cable	Model No.						
Standard Flexible Cable Assemblies							
See website for the following cable(s)							
75 Ohm, RG6A/U Coax				PE35350			
75 Ohm, RG59B/U Coax				PE35358			
75 Ohm, RG179B/U Coax				PE35362			

*Coax Performance at 1 GHz
Notes: Cable assembly max frequency may be lower than connector or coax max frequency

Continued on Next Page

Continued from Previous Page

**75 OHM TNC MALE TO
75 OHM BNC MALE**



Cable	Model No.	
75 Ohm, RG216/U Coax	PE35370	1

**75 OHM SMC PLUG TO
75 OHM SMC PLUG**



Cable	Model No.	
Standard Flexible Cable Assemblies		
See website for the following cable(s)		
75 Ohm, RG179B/U Coax	PE3376	2

**75 OHM SMC PLUG TO
75 OHM BNC MALE**



Cable Dia.	Atten.*	Max Power*	Length	Model No.	1-24	25-49	50-99		
Standard Flexible Cable Assemblies									
See website for the following cable(s)									
75 Ohm, RG59B/U Coax				PE33330					3
75 Ohm, RG179B/U Coax									
0.100" dia.	25 dB / 100 ft.	200 W	12"	PE33586-12	\$41.55	\$38.64	\$35.73	4	
			24"	PE33586-24	\$43.45	\$40.41	\$37.37		
			36"	PE33586-36	\$45.30	\$42.13	\$38.96		
			48"	PE33586-48	\$47.20	\$43.90	\$40.59		
			60"	PE33586-60	\$49.10	\$45.66	\$42.23		
Any	PE33586-XX	See Website for Pricing							
See website for the following cable(s)									
75 Ohm, PE-B150 Coax				PE33646					5

**75 OHM F MALE TO
75 OHM F MALE**



Cable Dia.	Atten.*	Max Power*	Length	Model No.	1-24	25-49	50-99		
Standard Flexible Cable Assemblies									
See website for the following cable(s)									
75 Ohm, RG6A/U Coax				PE37163					6
75 Ohm, RG6-CATV Coax									
0.275" dia.	6.5 dB / 100 ft.	6.5 W	12"	PE36132-12	\$14.80	\$13.76	\$12.73	7	
			24"	PE36132-24	\$16.10	\$14.97	\$13.85		
			36"	PE36132-36	\$17.35	\$16.14	\$14.92		
			48"	PE36132-48	\$18.15	\$16.88	\$15.61		
			60"	PE36132-60	\$18.95	\$17.62	\$16.30		
Any	PE36132-XX	See Website for Pricing							
75 Ohm, RG11A/U Coax									
0.405" dia.	9 dB / 100 ft.	150 W	12"	PE36135-12	\$16.35	\$15.21	\$14.06	8	
			24"	PE36135-24	\$18.00	\$16.74	\$15.48		
			36"	PE36135-36	\$19.35	\$18.00	\$16.64		
			48"	PE36135-48	\$20.75	\$19.30	\$17.85		
			60"	PE36135-60	\$22.20	\$20.65	\$19.09		
Any	PE36135-XX	See Website for Pricing							

**75 OHM F MALE TO
75 OHM F MALE**



Cable Dia.	Atten.*	Max Power*	Length	Model No.	1-24	25-49	50-99		
Standard Flexible Cable Assemblies									
75 Ohm, RG59B/U Coax									
0.242" dia.	11.5 dB / 100 ft.	77 W	12"	PE36141-12	\$11.35	\$10.56	\$9.76	9	
			24"	PE36141-24	\$12.05	\$11.21	\$10.36		
			36"	PE36141-36	\$12.80	\$11.90	\$11.01		
			48"	PE36141-48	\$13.50	\$12.56	\$11.61		
			60"	PE36141-60	\$14.25	\$13.25	\$12.26		
Any	PE36141-XX	See Website for Pricing							
See website for the following cable(s)									
75 Ohm, RG59-WHITE Coax				PE36143					10
75 Ohm, RG179B/U Coax									
0.100" dia.	25 dB / 100 ft.	200 W	12"	PE36137-12	\$18.20	\$16.93	\$15.65	11	
			24"	PE36137-24	\$19.60	\$18.23	\$16.86		
			36"	PE36137-36	\$21.20	\$19.72	\$18.23		
			48"	PE36137-48	\$22.50	\$20.93	\$19.35		
			60"	PE36137-60	\$23.90	\$22.23	\$20.55		
Any	PE36137-XX	See Website for Pricing							
See website for the following cable(s)									
75 Ohm, RG187A/U Coax				PE36139					12

**75 OHM F MALE TO 75 OHM
F MALE RIGHT ANGLE**



Cable	Model No.	
Standard Flexible Cable Assemblies		
See website for the following cable(s)		
75 Ohm, RG59B/U Coax	PE38343	13

**75 OHM F MALE TO
75 OHM BNC MALE**



Cable Dia.	Atten.*	Max Power*	Length	Model No.	1-24	25-49	50-99		
Standard Flexible Cable Assemblies									
75 Ohm, RG6-CATV Coax									
0.275" dia.	6.5 dB / 100 ft.	6.5 W	12"	PE36145-12	\$21.85	\$20.32	\$18.79	14	
			24"	PE36145-24	\$23.25	\$21.62	\$20.00		
			36"	PE36145-36	\$24.70	\$22.97	\$21.24		
			48"	PE36145-48	\$26.05	\$24.23	\$22.40		
			60"	PE36145-60	\$27.45	\$25.53	\$23.61		
Any	PE36145-XX	See Website for Pricing							
75 Ohm, RG59B/U Coax									
0.242" dia.	11.5 dB / 100 ft.	77 W	12"	PE36149-12	\$19.55	\$18.18	\$16.81	15	
			24"	PE36149-24	\$20.35	\$18.93	\$17.50		
			36"	PE36149-36	\$20.80	\$19.34	\$17.89		
			48"	PE36149-48	\$21.55	\$20.04	\$18.53		
			60"	PE36149-60	\$22.10	\$20.55	\$19.01		
Any	PE36149-XX	See Website for Pricing							
See website for the following cable(s)									
75 Ohm, RG59-WHITE Coax				PE36151					16
75 Ohm, RG179B/U Coax									
0.100" dia.	25 dB / 100 ft.	200 W	12"	PE36153-12	\$23.55	\$21.90	\$20.25	17	
			24"	PE36153-24	\$25.05	\$23.30	\$21.54		
			36"	PE36153-36	\$26.45	\$24.60	\$22.75		
			48"	PE36153-48	\$27.80	\$25.85	\$23.91		
			60"	PE36153-60	\$29.25	\$27.20	\$25.16		
Any	PE36153-XX	See Website for Pricing							

Cable Assemblies

*Coax Performance at 1 GHz
Notes: Cable assembly max frequency may be lower than connector or coax max frequency

Continued on Next Page

ROHS & REACH COMPLIANT. CUSTOM-LENGTH CABLE ASSEMBLIES MAY BE ORDERED ON OUR WEBSITE.

Continued from Previous Page

75 OHM F MALE TO
75 OHM BNC MALE



Cable Dia.	Atten.*	Max Power*	Length	Model No.	1-24	25-49	50-99
See website for the following cable(s)							
75 Ohm, RG187A/U Coax				PE36155			

75 OHM 1.6/5.6 PLUG TO
75 OHM BNC MALE



Cable	Model No.
Standard Flexible Cable Assemblies	
See website for the following cable(s)	
75 Ohm, RG59B/U Coax	PE36127

75 OHM SMB PLUG TO
75 OHM SMB PLUG



Cable Dia.	Atten.*	Max Power*	Length	Model No.	1-24	25-49	50-99
See website for the following cable(s)							
75 Ohm, RG59B/U Coax				PE3041			
75 Ohm, RG179B/U Coax							
0.100" dia.	25 dB / 100 ft.	200 W	12"	PE3100-12	\$47.75	\$44.41	\$41.07
			24"	PE3100-24	\$48.80	\$45.38	\$41.97
			36"	PE3100-36	\$49.80	\$46.31	\$42.83
			48"	PE3100-48	\$50.75	\$47.20	\$43.65
			60"	PE3100-60	\$51.80	\$48.17	\$44.55
Any			PE3100-XX	See Website for Pricing			

75 OHM SMB PLUG TO
75 OHM BNC MALE



Cable Dia.	Atten.*	Max Power*	Length	Model No.	1-24	25-49	50-99
See website for the following cable(s)							
75 Ohm, RG59B/U Coax				PE33270			
75 Ohm, RG179B/U Coax							
0.100" dia.	25 dB / 100 ft.	200 W	12"	PE33247-12	\$41.00	\$38.13	\$35.26
			24"	PE33247-24	\$41.95	\$39.01	\$36.08
			36"	PE33247-36	\$43.45	\$40.41	\$37.37
			48"	PE33247-48	\$45.30	\$42.13	\$38.96
			60"	PE33247-60	\$47.20	\$43.90	\$40.59
Any			PE33247-XX	See Website for Pricing			

75 OHM MINI SMB PLUG TO
75 OHM MINI SMB PLUG



Cable	Model No.
Standard Flexible Cable Assemblies	
See website for the following cable(s)	
75 Ohm, RG59B/U Coax	PE34681
75 Ohm, RG179B/U Coax	PE34683

75 OHM MINI SMB PLUG TO 75 OHM
MINI SMB PLUG RIGHT ANGLE



Cable	Model No.
Standard Flexible Cable Assemblies	
See website for the following cable(s)	
75 Ohm, RG59B/U Coax	PE34687
75 Ohm, RG179B/U Coax	PE34689

75 OHM MINI SMB PLUG RIGHT
ANGLE TO 75 OHM MINI SMB PLUG
RIGHT ANGLE



Cable	Model No.
Standard Flexible Cable Assemblies	
See website for the following cable(s)	
75 Ohm, RG179B/U Coax	PE34694

75 OHM MINI SMB PLUG TO
75 OHM BNC MALE



Cable	Model No.
Standard Flexible Cable Assemblies	
See website for the following cable(s)	
75 Ohm, RG59B/U Coax	PE34701
75 Ohm, RG179B/U Coax	PE34703
75 Ohm, RG187A/U Coax	PE34705
75 Ohm, PE-B159-BK Coax	PE38040/BK
75 Ohm, PE-B159-BL Coax	PE38040/BL
75 Ohm, PE-B159-GR Coax	PE38040/GR
75 Ohm, PE-B159-RD Coax	PE38040/RD
75 Ohm, PE-B159-WH Coax	PE38040/WH
75 Ohm, PE-B159-YW Coax	PE38040/YW

75 OHM RCA MALE TO 75 OHM
RCA FEMALE BULKHEAD

SEE MOUNTING HOLE SECTION ON PAGE 246



Cable	Model No.
Standard Flexible Cable Assemblies	
See website for the following cable(s)	
75 Ohm, PE-B159-BK Coax	PE38135/BK
75 Ohm, PE-B159-BL Coax	PE38135/BL
75 Ohm, PE-B159-GR Coax	PE38135/GR
75 Ohm, PE-B159-RD Coax	PE38135/RD
75 Ohm, PE-B159-WH Coax	PE38135/WH
75 Ohm, PE-B159-YW Coax	PE38135/YW

Coaxial cable was invented by English engineer and mathematician Oliver Heaviside, who patented the design in 1880.

Cable Assemblies

*Coax Performance at 1 GHz
Notes: Cable assembly max frequency may be lower than connector or coax max frequency



Free Freight Available
via UPS Ground
to USA & Canada



Real-Time Stock
Levels & Pricing
On Our WebSite



Toll-Free Technical
Support
(866) 727-8376



Same-Day Shipping,
Even Custom
Cable Assemblies

Cable Assemblies

*Coax Performance at 1 GHz
Notes: Cable assembly max frequency may be lower than connector or coax max frequency

75 OHM BNC MALE TO 75 OHM BNC MALE



Cable Dia.	Atten.*	Max Power*	Length	Model No.	1-24	25-49	50-99
------------	---------	------------	--------	-----------	------	-------	-------

Standard Flexible Cable Assemblies

75 Ohm, RG6A/U Coax							
0.332" dia.	11 dB / 100 ft.	125 W	12"	PE33197-12	\$41.90	\$38.97	\$36.03
			24"	PE33197-24	\$43.35	\$40.32	\$37.28
			36"	PE33197-36	\$44.80	\$41.66	\$38.53
			48"	PE33197-48	\$46.25	\$43.01	\$39.78
			60"	PE33197-60	\$47.70	\$44.36	\$41.02
			Any	PE33197-XX	See Website for Pricing		

75 Ohm, RG6-CATV Coax							
0.275" dia.	6.5 dB / 100 ft.	6.5 W	12"	PE37808-12	\$41.25	\$38.36	\$35.48
			24"	PE37808-24	\$42.00	\$39.06	\$36.12
			36"	PE37808-36	\$42.80	\$39.80	\$36.81
			48"	PE37808-48	\$43.60	\$40.55	\$37.50
			60"	PE37808-60	\$44.40	\$41.29	\$38.18
			Any	PE37808-XX	See Website for Pricing		

See website for the following cable(s)

75 Ohm, RG11A/U Coax	PE33399
----------------------	---------

75 Ohm, RG59B/U Coax							
0.242" dia.	11.5 dB / 100 ft.	77 W	12"	PE33188-12	\$31.55	\$29.34	\$27.13
			24"	PE33188-24	\$32.25	\$29.99	\$27.74
			36"	PE33188-36	\$33.00	\$30.69	\$28.38
			48"	PE33188-48	\$33.70	\$31.34	\$28.98
			60"	PE33188-60	\$34.45	\$32.04	\$29.63
			Any	PE33188-XX	See Website for Pricing		

75 Ohm, RG179B/U Coax							
0.100" dia.	25 dB / 100 ft.	200 W	12"	PE33401-12	\$37.40	\$34.78	\$32.16
			24"	PE33401-24	\$39.30	\$36.55	\$33.80
			36"	PE33401-36	\$41.15	\$38.27	\$35.39
			48"	PE33401-48	\$43.05	\$40.04	\$37.02
			60"	PE33401-60	\$44.55	\$41.43	\$38.31
			Any	PE33401-XX	See Website for Pricing		

75 Ohm, RG216/U Coax							
0.425" dia.	9 dB / 100 ft.	150 W	12"	PE33403-12	\$48.65	\$45.24	\$41.84
			24"	PE33403-24	\$49.90	\$46.41	\$42.91
			36"	PE33403-36	\$51.35	\$47.76	\$44.16
			48"	PE33403-48	\$52.90	\$49.20	\$45.49
			60"	PE33403-60	\$54.30	\$50.50	\$46.70
			Any	PE33403-XX	See Website for Pricing		

75 Ohm, PE-B150 Coax							
0.150" dia.	20 dB / 100 ft.	25 W	12"	PE33405-12	\$35.30	\$32.83	\$30.36
			24"	PE33405-24	\$35.90	\$33.39	\$30.87
			36"	PE33405-36	\$36.50	\$33.95	\$31.39
			48"	PE33405-48	\$37.05	\$34.46	\$31.86
			60"	PE33405-60	\$37.65	\$35.01	\$32.38
			Any	PE33405-XX	See Website for Pricing		

75 OHM BNC MALE TO 75 OHM BNC MALE RIGHT ANGLE



Cable Dia.	Atten.*	Max Power*	Length	Model No.	1-24	25-49	50-99
------------	---------	------------	--------	-----------	------	-------	-------

Standard Flexible Cable Assemblies

See website for the following cable(s)

75 Ohm, RG6A/U Coax	PE33407
---------------------	---------

75 OHM BNC MALE TO 75 OHM BNC MALE RIGHT ANGLE



Cable Dia.	Atten.*	Max Power*	Length	Model No.	1-24	25-49	50-99
------------	---------	------------	--------	-----------	------	-------	-------

Standard Flexible Cable Assemblies

75 Ohm, RG59B/U Coax							
0.242" dia.	11.5 dB / 100 ft.	77 W	12"	PE33196-12	\$45.95	\$42.73	\$39.52
			24"	PE33196-24	\$46.70	\$43.43	\$40.16
			36"	PE33196-36	\$47.45	\$44.13	\$40.81
			48"	PE33196-48	\$48.15	\$44.78	\$41.41
			60"	PE33196-60	\$48.90	\$45.48	\$42.05
			Any	PE33196-XX	See Website for Pricing		

75 Ohm, RG179B/U Coax							
0.100" dia.	25 dB / 100 ft.	200 W	12"	PE33412-12	\$46.35	\$43.11	\$39.86
			24"	PE33412-24	\$48.25	\$44.87	\$41.50
			36"	PE33412-36	\$50.15	\$46.64	\$43.13
			48"	PE33412-48	\$52.00	\$48.36	\$44.72
			60"	PE33412-60	\$53.90	\$50.13	\$46.35
			Any	PE33412-XX	See Website for Pricing		

See website for the following cable(s)

75 Ohm, RG187A/U Coax	PE33414
-----------------------	---------

75 OHM BNC MALE TO 75 OHM BNC FEMALE



Cable	Model No.
-------	-----------

Standard Flexible Cable Assemblies

See website for the following cable(s)

75 Ohm, RG6A/U Coax	PE33437	12
75 Ohm, RG59B/U Coax	PE33441	13
75 Ohm, RG179B/U Coax	PE33443	14

75 OHM BNC MALE TO 75 OHM BNC FEMALE BULKHEAD

SEE MOUNTING HOLE SECTION ON PAGE 246



Cable Dia.	Atten.*	Max Power*	Length	Model No.	1-24	25-49	50-99
------------	---------	------------	--------	-----------	------	-------	-------

Standard Flexible Cable Assemblies

75 Ohm, RG59B/U Coax							
0.242" dia.	11.5 dB / 100 ft.	77 W	12"	PE33179-12	\$45.05	\$41.90	\$38.74
			24"	PE33179-24	\$45.40	\$42.22	\$39.04
			36"	PE33179-36	\$45.90	\$42.69	\$39.47
			48"	PE33179-48	\$46.35	\$43.11	\$39.86
			60"	PE33179-60	\$46.75	\$43.48	\$40.21
			Any	PE33179-XX	See Website for Pricing		

See website for the following cable(s)

75 Ohm, RG179B/U Coax	PE33421	16
-----------------------	---------	----

The Banana connector, also referred to as a 4mm connector, was invented by Richard Hirschmann in 1924.

75 OHM BNC MALE RIGHT ANGLE TO 75 OHM BNC MALE RIGHT ANGLE



Cable Dia.	Atten.*	Max Power*	Length	Model No.	1-24	25-49	50-99
Standard Flexible Cable Assemblies							
75 Ohm, RG59B/U Coax							
0.242" dia.	11.5 dB / 100 ft.	77 W	12"	PE33430-12	\$60.40	\$56.17	\$51.94
			24"	PE33430-24	\$61.15	\$56.87	\$52.59
			36"	PE33430-36	\$61.85	\$57.52	\$53.19
			48"	PE33430-48	\$62.60	\$58.22	\$53.84
			60"	PE33430-60	\$63.35	\$58.92	\$54.48
			Any	PE33430-XX	See Website for Pricing		
See website for the following cable(s)							
75 Ohm, RG179B/U Coax				PE33432			
75 Ohm, RG187A/U Coax				PE33434			

75 OHM BNC FEMALE TO 75 OHM BNC FEMALE



Cable	Model No.
Standard Flexible Cable Assemblies	
See website for the following cable(s)	
75 Ohm, RG11A/U Coax	PE33450
75 Ohm, RG59B/U Coax	PE33452
75 Ohm, RG179B/U Coax	PE33451
75 Ohm, RG187A/U Coax	PE33456

BNC TWINAX PLUG TO BNC TWINAX PLUG



Cable Dia.	Atten.*	Max Power*	Length	Model No.	1-24	25-49	50-99
Standard Flexible Cable Assemblies							
78 Ohm, RG108A/U Twinax							
0.235" dia.	26.2 dB / 100 ft.	30 W	18"	PE3480-18	\$80.70	\$75.05	\$69.40
			36"	PE3480-36	\$81.60	\$75.89	\$70.18
			60"	PE3480-60	\$82.90	\$77.10	\$71.29
			90"	PE3480-90	\$84.40	\$78.49	\$72.58
			120"	PE3480-120	\$85.95	\$79.93	\$73.92
			180"	PE3480-180	\$89.10	\$82.86	\$76.63
			Any	PE3480-XX	See Website for Pricing		

3/4" -20 MALE TO 3/4" -20 MALE



Cable Dia.	Atten.*	Max Power*	Length	Model No.	1-24	25-49	50-99
Standard Flexible Cable Assemblies							
100 Ohm, PE-S330 Twinax							
0.330" dia.	N/A dB / 100 ft.	N/A W	18"	PE3930-18	\$60.15	\$55.94	\$51.73
			36"	PE3930-36	\$62.80	\$58.40	\$54.01
			60"	PE3930-60	\$66.30	\$61.66	\$57.02
			90"	PE3930-90	\$70.75	\$65.80	\$60.85
			120"	PE3930-120	\$75.05	\$69.80	\$64.54
			180"	PE3930-180	\$84.00	\$78.12	\$72.24
			Any	PE3930-XX	See Website for Pricing		

BANANA PLUG TO BANANA PLUG



Cable Dia.	Atten.*	Max Power*	Length	Model No.	1-24	25-49	50-99			
Standard Flexible Cable Assemblies										
See website for the following cable(s)										
50 Ohm, RG58C/U Coax				PE3005						
50 Ohm, RG142B/U Coax				PE33446						
50 Ohm, RG223/U Coax				PE33449						
BLACK WIRE										
dia.	- / 100 ft.	W	6"	PE9930-6-B	\$6.28	\$5.84	\$5.40			
			12"	PE9930-12-B	\$6.43	\$5.98	\$5.53			
			18"	PE9930-18-B	\$6.64	\$6.18	\$5.71			
			24"	PE9930-24-B	\$6.98	\$6.49	\$6.00			
			36"	PE9930-36-B	\$6.94	\$6.45	\$5.97			
			48"	PE9930-48-B	\$7.19	\$6.69	\$6.18			
			60"	PE9930-60-B	\$7.40	\$6.88	\$6.36			
			72"	PE9930-72-B	\$7.70	\$7.16	\$6.62			
			120"	PE9930-120-B	\$8.31	\$7.73	\$7.15			
			144"	PE9930-144-B	\$8.77	\$8.16	\$7.54			
						Any	PE9930-XX-B	See Website for Pricing		
			RED WIRE							
			dia.	- / 100 ft.	W	6"	PE9930-6-R	\$6.28	\$5.84	\$5.40
12"	PE9930-12-R	\$6.54				\$6.08	\$5.62			
18"	PE9930-18-R	\$6.64				\$6.18	\$5.71			
24"	PE9930-24-R	\$6.74				\$6.27	\$5.80			
36"	PE9930-36-R	\$6.94				\$6.45	\$5.97			
48"	PE9930-48-R	\$7.19				\$6.69	\$6.18			
60"	PE9930-60-R	\$7.40				\$6.88	\$6.36			
72"	PE9930-72-R	\$7.75				\$7.21	\$6.67			
120"	PE9930-120-R	\$8.31				\$7.73	\$7.15			
144"	PE9930-144-R	\$8.77				\$8.16	\$7.54			
						Any	PE9930-XX-R	See Website for Pricing		

BANANA PLUG TO ALLIGATOR CLIP





Cable Dia.	Atten.*	Max Power*	Length	Model No.	1-24	25-49	50-99			
Standard Flexible Cable Assemblies										
See website for the following cable(s)										
50 Ohm, RG58C/U Coax				PE3502						
50 Ohm, RG223/U Coax				PE3164						
BLACK WIRE										
dia.	- / 100 ft.	W	6"	PE9931-6-B	\$7.70	\$7.16	\$6.62			
			12"	PE9931-12-B	\$7.85	\$7.30	\$6.75			
			18"	PE9931-18-B	\$8.20	\$7.63	\$7.05			
			24"	PE9931-24-B	\$8.30	\$7.72	\$7.14			
			36"	PE9931-36-B	\$8.55	\$7.95	\$7.35			
			48"	PE9931-48-B	\$8.90	\$8.28	\$7.65			
			60"	PE9931-60-B	\$9.15	\$8.51	\$7.87			
			72"	PE9931-72-B	\$9.45	\$8.79	\$8.13			
						Any	PE9931-XX-B	See Website for Pricing		
			RED WIRE							
			dia.	- / 100 ft.	W	6"	PE9931-6-R	\$7.70	\$7.16	\$6.62
						12"	PE9931-12-R	\$7.85	\$7.30	\$6.75
						18"	PE9931-18-R	\$8.20	\$7.63	\$7.05
24"	PE9931-24-R	\$8.30				\$7.72	\$7.14			
36"	PE9931-36-R	\$8.55				\$7.95	\$7.35			
48"	PE9931-48-R	\$8.90				\$8.28	\$7.65			
60"	PE9931-60-R	\$9.15				\$8.51	\$7.87			
72"	PE9931-72-R	\$9.45				\$8.79	\$8.13			
						Any	PE9931-XX-R	See Website for Pricing		

Cable Assemblies

*Coax Performance at 1 GHz
Notes: Cable assembly max frequency may be lower than connector or coax max frequency

BANANA PLUG TO MINI ALLIGATOR CLIP							
ALL OF COLOR PATCH CORDS ARE RATED 2500 V, 5 AMPS AND +50° C.							
							
Cable Dia.	Atten.*	Max Power*	Length	Model No.	1-24	25-49	50-99
Standard Flexible Cable Assemblies							
BLACK WIRE							
- dia.	- / 100 ft.	- W	6"	PE9933-6-B	\$7.70	\$7.16	\$6.62
			12"	PE9933-12-B	\$7.85	\$7.30	\$6.75
			18"	PE9933-18-B	\$8.20	\$7.63	\$7.05
			24"	PE9933-24-B	\$8.30	\$7.72	\$7.14
			36"	PE9933-36-B	\$8.55	\$7.95	\$7.35
			48"	PE9933-48-B	\$8.90	\$8.28	\$7.65
			60"	PE9933-60-B	\$9.15	\$8.51	\$7.87
			72"	PE9933-72-B	\$9.45	\$8.79	\$8.13
			Any	PE9933-XX-B	See Website for Pricing		
RED WIRE							
- dia.	- / 100 ft.	- W	6"	PE9933-6-R	\$7.70	\$7.16	\$6.62
			12"	PE9933-12-R	\$7.85	\$7.30	\$6.75
			18"	PE9933-18-R	\$8.20	\$7.63	\$7.05
			24"	PE9933-24-R	\$8.30	\$7.72	\$7.14
			36"	PE9933-36-R	\$8.55	\$7.95	\$7.35
			48"	PE9933-48-R	\$8.90	\$8.28	\$7.65
			60"	PE9933-60-R	\$9.15	\$8.51	\$7.87
			72"	PE9933-72-R	\$9.45	\$8.79	\$8.13
			Any	PE9933-XX-R	See Website for Pricing		

ALLIGATOR CLIP TO ALLIGATOR CLIP									
ALL OF COLOR PATCH CORDS ARE RATED 2500 V, 5 AMPS AND +50° C.									
									
Cable Dia.	Atten.*	Max Power*	Length	Model No.	1-24	25-49	50-99		
Standard Flexible Cable Assemblies									
BLACK WIRE									
- dia.	- / 100 ft.	- W	6"	PE9932-6-B	\$7.70	\$7.16	\$6.62		
			12"	PE9932-12-B	\$7.85	\$7.30	\$6.75		
			18"	PE9932-18-B	\$8.20	\$7.63	\$7.05		
			24"	PE9932-24-B	\$8.30	\$7.72	\$7.14		
			30"	PE9932-30-B	\$8.45	\$7.86	\$7.27		
			36"	PE9932-36-B	\$8.55	\$7.95	\$7.35		
			48"	PE9932-48-B	\$8.90	\$8.28	\$7.65		
			60"	PE9932-60-B	\$9.15	\$8.51	\$7.87		
			72"	PE9932-72-B	\$9.45	\$8.79	\$8.13		
			Any	PE9932-XX-B	See Website for Pricing				
			RED WIRE						
- dia.	- / 100 ft.	- W	6"	PE9932-6-R	\$7.70	\$7.16	\$6.62		
			12"	PE9932-12-R	\$7.85	\$7.30	\$6.75		
			18"	PE9932-18-R	\$8.20	\$7.63	\$7.05		
			24"	PE9932-24-R	\$8.30	\$7.72	\$7.14		
			30"	PE9932-30-R	\$8.45	\$7.86	\$7.27		
			36"	PE9932-36-R	\$8.55	\$7.95	\$7.35		
			48"	PE9932-48-R	\$8.90	\$8.28	\$7.65		
			60"	PE9932-60-R	\$9.15	\$8.51	\$7.87		
			72"	PE9932-72-R	\$9.45	\$8.79	\$8.13		
			Any	PE9932-XX-R	See Website for Pricing				

BANANA PLUG TO SPADE LUG							
ALL OF COLOR PATCH CORDS ARE RATED 2500 V, 5 AMPS AND +50° C.							
							
Cable Dia.	Atten.*	Max Power*	Length	Model No.	1-24	25-49	50-99
Standard Flexible Cable Assemblies							
BLACK WIRE							
- dia.	- / 100 ft.	- W	6"	PE9936-6-B	\$7.70	\$7.16	\$6.62
			12"	PE9936-12-B	\$7.85	\$7.30	\$6.75
			18"	PE9936-18-B	\$8.20	\$7.63	\$7.05
			24"	PE9936-24-B	\$8.30	\$7.72	\$7.14
			36"	PE9936-36-B	\$8.55	\$7.95	\$7.35
			48"	PE9936-48-B	\$8.90	\$8.28	\$7.65
			60"	PE9936-60-B	\$9.15	\$8.51	\$7.87
			72"	PE9936-72-B	\$9.45	\$8.79	\$8.13
			Any	PE9936-XX-B	See Website for Pricing		
RED WIRE							
- dia.	- / 100 ft.	- W	6"	PE9936-6-R	\$7.70	\$7.16	\$6.62
			12"	PE9936-12-R	\$7.85	\$7.30	\$6.75
			18"	PE9936-18-R	\$8.20	\$7.63	\$7.05
			24"	PE9936-24-R	\$8.30	\$7.72	\$7.14
			36"	PE9936-36-R	\$8.55	\$7.95	\$7.35
			48"	PE9936-48-R	\$8.90	\$8.28	\$7.65
			60"	PE9936-60-R	\$9.15	\$8.51	\$7.87
			72"	PE9936-72-R	\$9.45	\$8.79	\$8.13
			Any	PE9936-XX-R	See Website for Pricing		

ALLIGATOR CLIP TO SPADE LUG										
ALL OF COLOR PATCH CORDS ARE RATED 2500 V, 5 AMPS AND +50° C.										
										
Cable Dia.	Atten.*	Max Power*	Length	Model No.	1-24	25-49	50-99			
Standard Flexible Cable Assemblies										
BLACK WIRE										
- dia.	- / 100 ft.	- W	6"	PE9935-6-B	\$7.70	\$7.16	\$6.62			
			12"	PE9935-12-B	\$7.85	\$7.30	\$6.75			
			18"	PE9935-18-B	\$8.20	\$7.63	\$7.05			
			24"	PE9935-24-B	\$8.30	\$7.72	\$7.14			
			36"	PE9935-36-B	\$8.55	\$7.95	\$7.35			
			48"	PE9935-48-B	\$8.90	\$8.28	\$7.65			
			60"	PE9935-60-B	\$9.15	\$8.51	\$7.87			
			72"	PE9935-72-B	\$9.45	\$8.79	\$8.13			
			Any	PE9935-XX-B	See Website for Pricing					
			RED WIRE							
			- dia.	- / 100 ft.	- W	6"	PE9935-6-R	\$7.70	\$7.16	\$6.62
12"	PE9935-12-R	\$7.85				\$7.30	\$6.75			
18"	PE9935-18-R	\$8.20				\$7.63	\$7.05			
24"	PE9935-24-R	\$8.30				\$7.72	\$7.14			
36"	PE9935-36-R	\$8.55				\$7.95	\$7.35			
48"	PE9935-48-R	\$8.90				\$8.28	\$7.65			
60"	PE9935-60-R	\$9.15				\$8.51	\$7.87			
72"	PE9935-72-R	\$9.45				\$8.79	\$8.13			
Any	PE9935-XX-R	See Website for Pricing								

**Heinrich Hertz was the first person
to demonstrate the existence of radio waves in 1888.**

MINI ALLIGATOR CLIP TO MINI ALLIGATOR CLIP							
ALL OF COLOR PATCH CORDS ARE RATED 2500 V, 5 AMPS AND +50° C.							
							
Cable Dia.	Atten.*	Max Power*	Length	Model No.	1-24	25-49	50-99
Standard Flexible Cable Assemblies							
BLACK WIRE							
-	-	-	6"	PE9934-6-B	\$7.70	\$7.16	\$6.62
			12"	PE9934-12-B	\$7.85	\$7.30	\$6.75
			18"	PE9934-18-B	\$8.20	\$7.63	\$7.05
			24"	PE9934-24-B	\$8.30	\$7.72	\$7.14
			36"	PE9934-36-B	\$8.55	\$7.95	\$7.35
			48"	PE9934-48-B	\$8.90	\$8.28	\$7.65
			60"	PE9934-60-B	\$9.15	\$8.51	\$7.87
			72"	PE9934-72-B	\$9.45	\$8.79	\$8.13
	Any	PE9934-XX-B	See Website for Pricing				
RED WIRE							
-	-	-	6"	PE9934-6-R	\$7.70	\$7.16	\$6.62
			12"	PE9934-12-R	\$7.85	\$7.30	\$6.75
			18"	PE9934-18-R	\$8.20	\$7.63	\$7.05
			24"	PE9934-24-R	\$8.30	\$7.72	\$7.14
			36"	PE9934-36-R	\$8.55	\$7.95	\$7.35
			48"	PE9934-48-R	\$8.90	\$8.28	\$7.65
			60"	PE9934-60-R	\$9.15	\$8.51	\$7.87
			72"	PE9934-72-R	\$9.45	\$8.79	\$8.13
	Any	PE9934-XX-R	See Website for Pricing				

Microwaves are good for transmitting information from one place to another because microwave energy can penetrate haze, light rain, snow, clouds, and smoke.



Notes

*Coax Performance at 1 GHz
Notes: Cable assembly max frequency may be lower than connector or coax max frequency

BREAKOUTS

ALL BREAKOUTS HAVE APPROXIMATELY 6" LONG RED AND BLACK LEADS
 For the complete selection of our cable assemblies, please visit the Cable Assemblies section on our website at www.pasternack.com

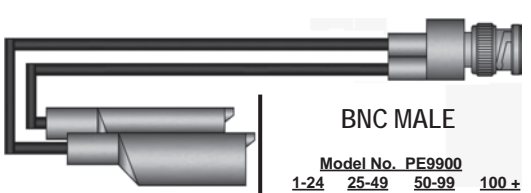
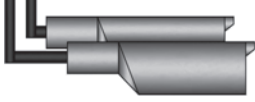
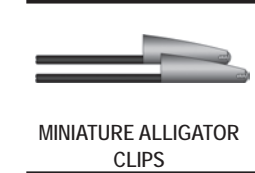
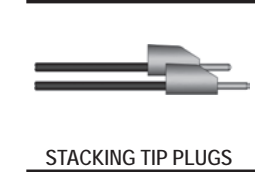
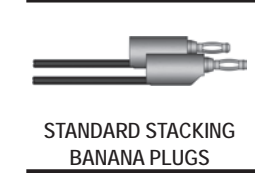
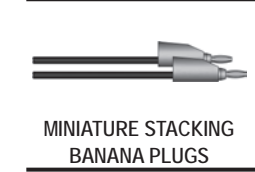
Cable Assemblies

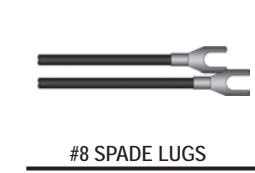
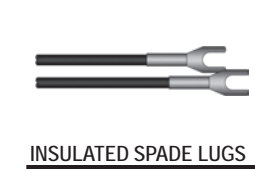
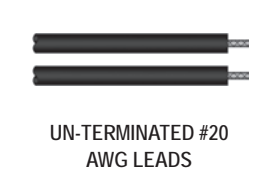
 BNC MALE  STANDARD ALLIGATOR CLIPS	<p>Model No. PE9900</p> <table border="1"> <tr> <td>1-24</td> <td>25-49</td> <td>50-99</td> <td>100+</td> </tr> <tr> <td>\$13.12</td> <td>\$12.20</td> <td>\$11.28</td> <td>\$10.50</td> </tr> </table>	1-24	25-49	50-99	100+	\$13.12	\$12.20	\$11.28	\$10.50	<p>Model No. PE9909</p> <table border="1"> <tr> <td>1-24</td> <td>25-49</td> <td>50-99</td> <td>100+</td> </tr> <tr> <td>\$11.86</td> <td>\$11.03</td> <td>\$10.20</td> <td>\$9.49</td> </tr> </table>	1-24	25-49	50-99	100+	\$11.86	\$11.03	\$10.20	\$9.49	<p>Model No. PE9950</p> <table border="1"> <tr> <td>1-24</td> <td>25-49</td> <td>50-99</td> <td>100+</td> </tr> <tr> <td>\$13.32</td> <td>\$12.39</td> <td>\$11.46</td> <td>\$10.66</td> </tr> </table>	1-24	25-49	50-99	100+	\$13.32	\$12.39	\$11.46	\$10.66	<p>Model No. PE9959</p> <table border="1"> <tr> <td>1-24</td> <td>25-49</td> <td>50-99</td> <td>100+</td> </tr> <tr> <td>\$13.32</td> <td>\$12.39</td> <td>\$11.46</td> <td>\$10.66</td> </tr> </table>	1-24	25-49	50-99	100+	\$13.32	\$12.39	\$11.46	\$10.66
1-24	25-49	50-99	100+																																	
\$13.12	\$12.20	\$11.28	\$10.50																																	
1-24	25-49	50-99	100+																																	
\$11.86	\$11.03	\$10.20	\$9.49																																	
1-24	25-49	50-99	100+																																	
\$13.32	\$12.39	\$11.46	\$10.66																																	
1-24	25-49	50-99	100+																																	
\$13.32	\$12.39	\$11.46	\$10.66																																	
 MINIATURE ALLIGATOR CLIPS	<p>Model No. PE9901</p> <table border="1"> <tr> <td>1-24</td> <td>25-49</td> <td>50-99</td> <td>100+</td> </tr> <tr> <td>\$13.12</td> <td>\$12.20</td> <td>\$11.28</td> <td>\$10.50</td> </tr> </table>	1-24	25-49	50-99	100+	\$13.12	\$12.20	\$11.28	\$10.50	<p>Model No. PE9910</p> <table border="1"> <tr> <td>1-24</td> <td>25-49</td> <td>50-99</td> <td>100+</td> </tr> <tr> <td>\$11.86</td> <td>\$11.03</td> <td>\$10.20</td> <td>\$9.49</td> </tr> </table>	1-24	25-49	50-99	100+	\$11.86	\$11.03	\$10.20	\$9.49	<p>Model No. PE9951</p> <table border="1"> <tr> <td>1-24</td> <td>25-49</td> <td>50-99</td> <td>100+</td> </tr> <tr> <td>\$12.06</td> <td>\$11.22</td> <td>\$10.37</td> <td>\$9.65</td> </tr> </table>	1-24	25-49	50-99	100+	\$12.06	\$11.22	\$10.37	\$9.65	<p>Model No. PE9960</p> <table border="1"> <tr> <td>1-24</td> <td>25-49</td> <td>50-99</td> <td>100+</td> </tr> <tr> <td>\$13.32</td> <td>\$12.39</td> <td>\$11.46</td> <td>\$10.66</td> </tr> </table>	1-24	25-49	50-99	100+	\$13.32	\$12.39	\$11.46	\$10.66
1-24	25-49	50-99	100+																																	
\$13.12	\$12.20	\$11.28	\$10.50																																	
1-24	25-49	50-99	100+																																	
\$11.86	\$11.03	\$10.20	\$9.49																																	
1-24	25-49	50-99	100+																																	
\$12.06	\$11.22	\$10.37	\$9.65																																	
1-24	25-49	50-99	100+																																	
\$13.32	\$12.39	\$11.46	\$10.66																																	
 STACKING TIP PLUGS	<p>Model No. PE9902</p> <table border="1"> <tr> <td>1-24</td> <td>25-49</td> <td>50-99</td> <td>100+</td> </tr> <tr> <td>\$15.55</td> <td>\$14.46</td> <td>\$13.37</td> <td>\$12.44</td> </tr> </table>	1-24	25-49	50-99	100+	\$15.55	\$14.46	\$13.37	\$12.44	<p>Model No. PE9911</p> <table border="1"> <tr> <td>1-24</td> <td>25-49</td> <td>50-99</td> <td>100+</td> </tr> <tr> <td>\$14.29</td> <td>\$13.29</td> <td>\$12.29</td> <td>\$11.43</td> </tr> </table>	1-24	25-49	50-99	100+	\$14.29	\$13.29	\$12.29	\$11.43	<p>Model No. PE9952</p> <table border="1"> <tr> <td>1-24</td> <td>25-49</td> <td>50-99</td> <td>100+</td> </tr> <tr> <td>\$14.54</td> <td>\$13.52</td> <td>\$12.50</td> <td>\$11.63</td> </tr> </table>	1-24	25-49	50-99	100+	\$14.54	\$13.52	\$12.50	\$11.63	<p>Model No. PE9961</p> <table border="1"> <tr> <td>1-24</td> <td>25-49</td> <td>50-99</td> <td>100+</td> </tr> <tr> <td>\$15.81</td> <td>\$14.70</td> <td>\$13.60</td> <td>\$12.65</td> </tr> </table>	1-24	25-49	50-99	100+	\$15.81	\$14.70	\$13.60	\$12.65
1-24	25-49	50-99	100+																																	
\$15.55	\$14.46	\$13.37	\$12.44																																	
1-24	25-49	50-99	100+																																	
\$14.29	\$13.29	\$12.29	\$11.43																																	
1-24	25-49	50-99	100+																																	
\$14.54	\$13.52	\$12.50	\$11.63																																	
1-24	25-49	50-99	100+																																	
\$15.81	\$14.70	\$13.60	\$12.65																																	
 STANDARD STACKING BANANA PLUGS	<p>Model No. PE9903</p> <table border="1"> <tr> <td>1-24</td> <td>25-49</td> <td>50-99</td> <td>100+</td> </tr> <tr> <td>\$14.29</td> <td>\$13.29</td> <td>\$12.29</td> <td>\$11.43</td> </tr> </table>	1-24	25-49	50-99	100+	\$14.29	\$13.29	\$12.29	\$11.43	<p>Model No. PE9912</p> <table border="1"> <tr> <td>1-24</td> <td>25-49</td> <td>50-99</td> <td>100+</td> </tr> <tr> <td>\$13.12</td> <td>\$12.20</td> <td>\$11.28</td> <td>\$10.50</td> </tr> </table>	1-24	25-49	50-99	100+	\$13.12	\$12.20	\$11.28	\$10.50	<p>Model No. PE9953</p> <table border="1"> <tr> <td>1-24</td> <td>25-49</td> <td>50-99</td> <td>100+</td> </tr> <tr> <td>\$13.32</td> <td>\$12.39</td> <td>\$11.46</td> <td>\$10.66</td> </tr> </table>	1-24	25-49	50-99	100+	\$13.32	\$12.39	\$11.46	\$10.66	<p>Model No. PE9962</p> <table border="1"> <tr> <td>1-24</td> <td>25-49</td> <td>50-99</td> <td>100+</td> </tr> <tr> <td>\$14.54</td> <td>\$13.52</td> <td>\$12.50</td> <td>\$11.63</td> </tr> </table>	1-24	25-49	50-99	100+	\$14.54	\$13.52	\$12.50	\$11.63
1-24	25-49	50-99	100+																																	
\$14.29	\$13.29	\$12.29	\$11.43																																	
1-24	25-49	50-99	100+																																	
\$13.12	\$12.20	\$11.28	\$10.50																																	
1-24	25-49	50-99	100+																																	
\$13.32	\$12.39	\$11.46	\$10.66																																	
1-24	25-49	50-99	100+																																	
\$14.54	\$13.52	\$12.50	\$11.63																																	
 MINIATURE STACKING BANANA PLUGS	<p>Model No. PE9904</p> <table border="1"> <tr> <td>1-24</td> <td>25-49</td> <td>50-99</td> <td>100+</td> </tr> <tr> <td>\$15.55</td> <td>\$14.46</td> <td>\$13.37</td> <td>\$12.44</td> </tr> </table>	1-24	25-49	50-99	100+	\$15.55	\$14.46	\$13.37	\$12.44	<p>Model No. PE9913</p> <table border="1"> <tr> <td>1-24</td> <td>25-49</td> <td>50-99</td> <td>100+</td> </tr> <tr> <td>\$14.29</td> <td>\$13.29</td> <td>\$12.29</td> <td>\$11.43</td> </tr> </table>	1-24	25-49	50-99	100+	\$14.29	\$13.29	\$12.29	\$11.43	<p>Model No. PE9954</p> <table border="1"> <tr> <td>1-24</td> <td>25-49</td> <td>50-99</td> <td>100+</td> </tr> <tr> <td>\$14.54</td> <td>\$13.52</td> <td>\$12.50</td> <td>\$11.63</td> </tr> </table>	1-24	25-49	50-99	100+	\$14.54	\$13.52	\$12.50	\$11.63	<p>Model No. PE9963</p> <table border="1"> <tr> <td>1-24</td> <td>25-49</td> <td>50-99</td> <td>100+</td> </tr> <tr> <td>\$15.81</td> <td>\$14.70</td> <td>\$13.60</td> <td>\$12.65</td> </tr> </table>	1-24	25-49	50-99	100+	\$15.81	\$14.70	\$13.60	\$12.65
1-24	25-49	50-99	100+																																	
\$15.55	\$14.46	\$13.37	\$12.44																																	
1-24	25-49	50-99	100+																																	
\$14.29	\$13.29	\$12.29	\$11.43																																	
1-24	25-49	50-99	100+																																	
\$14.54	\$13.52	\$12.50	\$11.63																																	
1-24	25-49	50-99	100+																																	
\$15.81	\$14.70	\$13.60	\$12.65																																	
 SAFETY HOOKS	<p>Model No. PE9905</p> <table border="1"> <tr> <td>1-24</td> <td>25-49</td> <td>50-99</td> <td>100+</td> </tr> <tr> <td>\$14.29</td> <td>\$13.29</td> <td>\$12.29</td> <td>\$11.43</td> </tr> </table>	1-24	25-49	50-99	100+	\$14.29	\$13.29	\$12.29	\$11.43	<p>Model No. PE9914</p> <table border="1"> <tr> <td>1-24</td> <td>25-49</td> <td>50-99</td> <td>100+</td> </tr> <tr> <td>\$13.12</td> <td>\$12.20</td> <td>\$11.28</td> <td>\$10.50</td> </tr> </table>	1-24	25-49	50-99	100+	\$13.12	\$12.20	\$11.28	\$10.50	<p>Model No. PE9955</p> <table border="1"> <tr> <td>1-24</td> <td>25-49</td> <td>50-99</td> <td>100+</td> </tr> <tr> <td>\$13.32</td> <td>\$12.39</td> <td>\$11.46</td> <td>\$10.66</td> </tr> </table>	1-24	25-49	50-99	100+	\$13.32	\$12.39	\$11.46	\$10.66	<p>Model No. PE9964</p> <table border="1"> <tr> <td>1-24</td> <td>25-49</td> <td>50-99</td> <td>100+</td> </tr> <tr> <td>\$14.54</td> <td>\$13.525</td> <td>\$12.50</td> <td>\$11.63</td> </tr> </table>	1-24	25-49	50-99	100+	\$14.54	\$13.525	\$12.50	\$11.63
1-24	25-49	50-99	100+																																	
\$14.29	\$13.29	\$12.29	\$11.43																																	
1-24	25-49	50-99	100+																																	
\$13.12	\$12.20	\$11.28	\$10.50																																	
1-24	25-49	50-99	100+																																	
\$13.32	\$12.39	\$11.46	\$10.66																																	
1-24	25-49	50-99	100+																																	
\$14.54	\$13.525	\$12.50	\$11.63																																	
 #8 SPADE LUGS	<p>Model No. PE9906</p> <table border="1"> <tr> <td>1-24</td> <td>25-49</td> <td>50-99</td> <td>100+</td> </tr> <tr> <td>\$11.86</td> <td>\$11.03</td> <td>\$10.20</td> <td>\$9.49</td> </tr> </table>	1-24	25-49	50-99	100+	\$11.86	\$11.03	\$10.20	\$9.49	<p>Model No. PE9915</p> <table border="1"> <tr> <td>1-24</td> <td>25-49</td> <td>50-99</td> <td>100+</td> </tr> <tr> <td>\$10.74</td> <td>\$9.99</td> <td>\$9.24</td> <td>\$8.59</td> </tr> </table>	1-24	25-49	50-99	100+	\$10.74	\$9.99	\$9.24	\$8.59	<p>Model No. PE9956</p> <table border="1"> <tr> <td>1-24</td> <td>25-49</td> <td>50-99</td> <td>100+</td> </tr> <tr> <td>\$10.94</td> <td>\$10.17</td> <td>\$9.41</td> <td>\$8.75</td> </tr> </table>	1-24	25-49	50-99	100+	\$10.94	\$10.17	\$9.41	\$8.75	<p>Model No. PE9965</p> <table border="1"> <tr> <td>1-24</td> <td>25-49</td> <td>50-99</td> <td>100+</td> </tr> <tr> <td>\$11.86</td> <td>\$11.03</td> <td>\$10.20</td> <td>\$9.49</td> </tr> </table>	1-24	25-49	50-99	100+	\$11.86	\$11.03	\$10.20	\$9.49
1-24	25-49	50-99	100+																																	
\$11.86	\$11.03	\$10.20	\$9.49																																	
1-24	25-49	50-99	100+																																	
\$10.74	\$9.99	\$9.24	\$8.59																																	
1-24	25-49	50-99	100+																																	
\$10.94	\$10.17	\$9.41	\$8.75																																	
1-24	25-49	50-99	100+																																	
\$11.86	\$11.03	\$10.20	\$9.49																																	
 INSULATED SPADE LUGS	<p>Model No. PE9907</p> <table border="1"> <tr> <td>1-24</td> <td>25-49</td> <td>50-99</td> <td>100+</td> </tr> <tr> <td>\$13.12</td> <td>\$12.20</td> <td>\$11.28</td> <td>\$10.50</td> </tr> </table>	1-24	25-49	50-99	100+	\$13.12	\$12.20	\$11.28	\$10.50	<p>Model No. PE9916</p> <table border="1"> <tr> <td>1-24</td> <td>25-49</td> <td>50-99</td> <td>100+</td> </tr> <tr> <td>\$11.86</td> <td>\$11.03</td> <td>\$10.20</td> <td>\$9.49</td> </tr> </table>	1-24	25-49	50-99	100+	\$11.86	\$11.03	\$10.20	\$9.49	<p>Model No. PE9957</p> <table border="1"> <tr> <td>1-24</td> <td>25-49</td> <td>50-99</td> <td>100+</td> </tr> <tr> <td>\$12.06</td> <td>\$11.22</td> <td>\$10.37</td> <td>\$9.65</td> </tr> </table>	1-24	25-49	50-99	100+	\$12.06	\$11.22	\$10.37	\$9.65	<p>Model No. PE9966</p> <table border="1"> <tr> <td>1-24</td> <td>25-49</td> <td>50-99</td> <td>100+</td> </tr> <tr> <td>\$13.12</td> <td>\$12.20</td> <td>\$11.28</td> <td>\$10.50</td> </tr> </table>	1-24	25-49	50-99	100+	\$13.12	\$12.20	\$11.28	\$10.50
1-24	25-49	50-99	100+																																	
\$13.12	\$12.20	\$11.28	\$10.50																																	
1-24	25-49	50-99	100+																																	
\$11.86	\$11.03	\$10.20	\$9.49																																	
1-24	25-49	50-99	100+																																	
\$12.06	\$11.22	\$10.37	\$9.65																																	
1-24	25-49	50-99	100+																																	
\$13.12	\$12.20	\$11.28	\$10.50																																	
 UN-TERMINATED #20 AWG LEADS	<p>Model No. PE9908</p> <table border="1"> <tr> <td>1-24</td> <td>25-49</td> <td>50-99</td> <td>100+</td> </tr> <tr> <td>\$10.12</td> <td>\$9.41</td> <td>\$8.70</td> <td>\$8.10</td> </tr> </table>	1-24	25-49	50-99	100+	\$10.12	\$9.41	\$8.70	\$8.10	<p>Model No. PE9917</p> <table border="1"> <tr> <td>1-24</td> <td>25-49</td> <td>50-99</td> <td>100+</td> </tr> <tr> <td>\$8.61</td> <td>\$8.01</td> <td>\$7.40</td> <td>\$6.89</td> </tr> </table>	1-24	25-49	50-99	100+	\$8.61	\$8.01	\$7.40	\$6.89	<p>Model No. PE9958</p> <table border="1"> <tr> <td>1-24</td> <td>25-49</td> <td>50-99</td> <td>100+</td> </tr> <tr> <td>\$8.77</td> <td>\$8.16</td> <td>\$7.54</td> <td>\$7.02</td> </tr> </table>	1-24	25-49	50-99	100+	\$8.77	\$8.16	\$7.54	\$7.02	<p>Model No. PE9967</p> <table border="1"> <tr> <td>1-24</td> <td>25-49</td> <td>50-99</td> <td>100+</td> </tr> <tr> <td>\$9.58</td> <td>\$8.91</td> <td>\$8.24</td> <td>\$7.66</td> </tr> </table>	1-24	25-49	50-99	100+	\$9.58	\$8.91	\$8.24	\$7.66
1-24	25-49	50-99	100+																																	
\$10.12	\$9.41	\$8.70	\$8.10																																	
1-24	25-49	50-99	100+																																	
\$8.61	\$8.01	\$7.40	\$6.89																																	
1-24	25-49	50-99	100+																																	
\$8.77	\$8.16	\$7.54	\$7.02																																	
1-24	25-49	50-99	100+																																	
\$9.58	\$8.91	\$8.24	\$7.66																																	

CONNECTOR FREQUENCY RANGE CHART

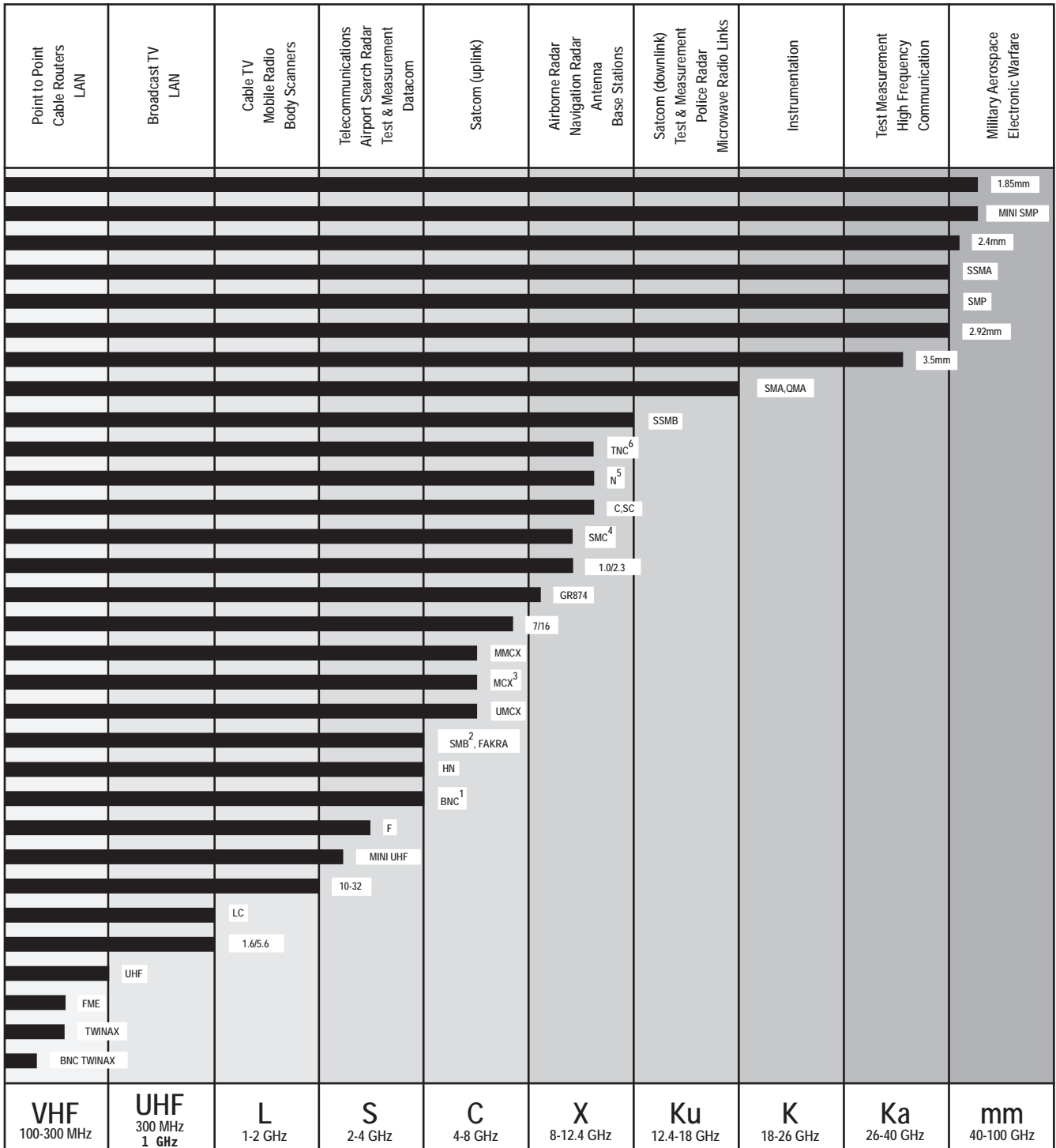

Connectors

See Our Website For Real-Time Stock Availability!

Notes:

- 1: BNC-75 Ohm connectors operate up to 1 GHz
- 2: SMB-75 Ohm & Mini SMB-75 Ohm connectors operate up to 4 GHz
- 3: MCX-75 Ohm connectors operate up to 6 GHz
- 4: SMC-75 Ohm connectors operate up to 10 GHz
- 5: N-75 Ohm connectors operate up to 1.5 GHz
- 6: TNC-75 Ohm connectors operate up to 1 GHz

Connector Selection Guide

3 Easy Ways to Find your Product.....

1. Search by PE Part Number

If you know the PE part number you are searching for, please reference our Part Number Index on Page 253.

2. Quick Reference Guide

(Page number refers to first appearance of product in the Connector Section)

Connector Series	Page	Connector Series	Page	Connector Series	Page	Connector Series	Page
1.0/2.3	116	75 Ohm MINI SMB	132	GR874	119	RCA	134
1.85mm	92	75 Ohm N	125	HN	107	SC	106
10-32	106	75 Ohm SMB	130	LC	107	SHV	124
2.4mm	92	75 Ohm SMC	127	MC-CARD	117	SMA	83
2.92mm	91	75 Ohm TNC	126	MCX	111	SMB	112
3.5mm	90	Banana Plug	135	MHV	123	SMC	104
3/4"-20 Twinax	134	BNC	119	MINI SMP	110	SMP	109
7/16 DIN	101	BNC Twinax	135	MINI UHF	103	SSMA	93
75 Ohm 1.6/5.6	129	C	124	MMCX	110	SSMB	114
75 Ohm BNC	132	D-Sub Contacts	117	N	94	TNC	98
75 Ohm F	128	FAKRA	115	QMA	108	UHF	102
75 Ohm MCX	130	FME	104	QN	109	UMCX	110

Connectors

3. Connector Locator

Connector Type	Page
1.0/2.3 Jack Connectors	
Straight, Bulkhead Mount, Cable Connectors	116
Right Angle, Bulkhead Mount, Cable Connectors	116
Straight, PCB Mount	117
Straight, Bulkhead Mount, PCB Mount	117
Right Angle, PCB Mount	117
1.0/2.3 Plug Connectors	
Straight, Cable Connectors	116
Right Angle, Cable Connectors	116
1.85mm Female Connectors	
Straight, Threaded Mount, Field Replaceable	92
Straight, Panel Mount, Field Replaceable	93
1.85mm Male Connectors	
Straight, Cable Connectors	92
Straight, Threaded Mount, Field Replaceable	92
10-32 Female Connectors	
Straight, Cable Connectors	106
Straight, Bulkhead Mount, Cable Connectors	106
Straight, Bulkhead Mount, Terminal	106
Straight, PCB Mount	106
Right Angle, PCB Mount	106
10-32 Male Connectors	
Straight, Cable Connectors	106
Right Angle, Cable Connectors	106

Connector Type	Page
2.4mm Female Connectors	
Straight, Cable Connectors	92
Straight, Bulkhead Mount, Cable Connectors	92
Straight, Panel Mount, Terminal	92
Straight, Threaded Mount, Field Replaceable	92
2.4mm Male Connectors	
Straight, Cable Connectors	92
Straight, Panel Mount, Terminal	92
Straight, Threaded Mount, Field Replaceable	92
2.92mm Female Connectors	
Straight, Cable Connectors	91
Straight, Bulkhead Mount, Cable Connectors	91
Straight, Threaded Mount, Field Replaceable	91
Straight, Panel Mount, Field Replaceable	91
2.92mm Male Connectors	
Straight, Cable Connectors	91
Straight, Panel Mount, Terminal	91
Straight, Threaded Mount, Field Replaceable	91
Straight, Panel Mount, Field Replaceable	91
3.5mm Female Connectors	
Straight, Cable Connectors	91
Straight, Bulkhead Mount, Cable Connectors	91
3.5mm Male Connectors	
Straight, Cable Connectors	90

See Our Website For Real-Time Stock Availability!

Connector Locator

Connector Type	Page
3/4"-20 Threaded Twinax Female Connectors	
Straight, Cable Connectors	134
Straight, Bulkhead Mount, Terminal	134
Straight, Panel Mount, Terminal	134
3/4"-20 Threaded Twinax Male Connectors	
Straight, Cable Connectors	134
7/16 DIN Female Connectors	
Straight, Cable Connectors	101
Straight, Bulkhead Mount, Cable Connectors	102
Straight, Panel Mount, Cable Connectors	102
Straight, Bulkhead Mount, Terminal	102
Straight, Panel Mount, Terminal	102
7/16 DIN Male Connectors	
Straight, Cable Connectors	101
Right Angle, Cable Connectors	101
75 Ohm 1.6/5.6 Jack Connectors	
Straight, Bulkhead Mount, Cable Connectors	129
Right Angle, Bulkhead Mount, Cable Connectors	129
Straight, Bulkhead Mount, PCB Mount	129
Right Angle, PCB Mount	129
75 Ohm 1.6/5.6 Plug Connectors	
Straight, Cable Connectors	129
Right Angle, Cable Connectors	129
75 Ohm BNC Female Connectors	
Straight, Cable Connectors	133
Straight, Bulkhead Mount, Cable Connectors	133
Straight, Panel Mount, Cable Connectors	133
Straight, Bulkhead Mount, Terminal	133
Right Angle, Bulkhead Mount, Terminal	133
Straight, Panel Mount, Terminal	134
Right Angle, Panel Mount, Terminal	134
Straight, PCB Mount	134
Straight, Bulkhead Mount, PCB Mount	134
75 Ohm BNC Male Connectors	
Straight, Cable Connectors	132
Right Angle, Cable Connectors	133
Straight, Bulkhead Mount, Terminal	133
Straight, Panel Mount, Terminal	133
75 Ohm F Female Connectors	
Straight, Bulkhead Mount, Cable Connectors	128
Straight, Bulkhead Mount, Terminal	128
Straight, Panel Mount, Terminal	128
Straight, PCB Mount	129
Right Angle, PCB Mount	129
Straight, Bulkhead Mount, PCB Mount	129
Right Angle, Bulkhead Mount, PCB Mount	129
75 Ohm F Male Connectors	
Straight, Cable Connectors	128
Right Angle, Cable Connectors	128
75 Ohm MCX Jack Connectors	
Straight, Cable Connectors	130
Straight, Bulkhead Mount, Cable Connectors	130
Straight, Bulkhead Mount, Terminal	130
Straight, PCB Mount	130
Right Angle, PCB Mount	130

Connector Type	Page
75 Ohm MCX Plug Connectors	
Straight, Cable Connectors	130
Right Angle, Cable Connectors	130
Straight, PCB Mount	130
75 Ohm MINI SMB Jack Connectors	
Straight, Cable Connectors	132
Straight, Panel Mount, Terminal	132
Straight, PCB Mount	132
Right Angle, PCB Mount	132
Straight, Bulkhead Mount, PCB Mount	132
Right Angle, Bulkhead Mount, PCB Mount	132
75 Ohm MINI SMB Plug Connectors	
Straight, Cable Connectors	132
Right Angle, Cable Connectors	132
75 Ohm N Female Connectors	
Straight, Cable Connectors	126
Straight, Bulkhead Mount, Terminal	126
Straight, Panel Mount, Terminal	126
75 Ohm N Male Connectors	
Straight, Cable Connectors	125
Right Angle, Cable Connectors	126
Straight, Panel Mount, Terminal	126
75 Ohm SMB Jack Connectors	
Straight, Cable Connectors	131
Straight, Bulkhead Mount, Cable Connectors	131
Straight, Terminal	131
Straight, Bulkhead Mount, Terminal	131
Right Angle, Bulkhead Mount, Terminal	131
Right Angle, PCB Mount	131
75 Ohm SMB Plug Connectors	
Straight, Cable Connectors	130
Right Angle, Cable Connectors	131
Straight, Bulkhead Mount, Terminal	131
Straight, PCB Mount	131
Right Angle, PCB Mount	131
75 Ohm SMC Jack Connectors	
Straight, Cable Connectors	127
Straight, Bulkhead Mount, Cable Connectors	127
Straight, Bulkhead Mount, Terminal	127
Right Angle, Bulkhead Mount, Terminal	127
Straight, PCB Mount	128
Right Angle, PCB Mount	128
75 Ohm SMC Plug Connectors	
Straight, Cable Connectors	127
Right Angle, Cable Connectors	127
Straight, Bulkhead Mount, Terminal	127
Straight, PCB Mount	127
Right Angle, PCB Mount	127
75 Ohm TNC Female Connectors	
Straight, Bulkhead Mount, Cable Connectors	126
Straight, Bulkhead Mount, Terminal	126
Straight, Panel Mount, Terminal	126
75 Ohm TNC Male Connectors	
Straight, Cable Connectors	126
Right Angle, Cable Connectors	126

Connector Locator

Connector Type	Page
Banana Plug Plug Connectors	
Straight, Cable Connectors	135
BNC Female Connectors	
Straight, Cable Connectors	120
Straight, Bulkhead Mount, Cable Connectors	120
Straight, Panel Mount, Cable Connectors	120
Reverse Polarity Straight, Cable Connectors	121
Reverse Polarity Straight, Bulkhead Mount, Cable Connectors	121
Reverse Polarity Straight, Panel Mount, Cable Connectors	121
Straight, Bulkhead Mount, Terminal	121
Right Angle, Bulkhead Mount, Terminal	122
Straight, Panel Mount, Terminal	122
Right Angle, Panel Mount, Terminal	122
Reverse Polarity Straight, Bulkhead Mount, Terminal	122
Reverse Polarity Right Angle, Bulkhead Mount, Terminal	122
Reverse Polarity Straight, Panel Mount, Terminal	122
Reverse Polarity Right Angle, Panel Mount, Terminal	122
Straight, PCB Mount	122
Straight, Bulkhead Mount, PCB Mount	122
BNC Male Connectors	
Straight, Cable Connectors	119
Right Angle, Cable Connectors	119
Reverse Polarity Straight, Cable Connectors	120
Reverse Polarity Right Angle, Cable Connectors	121
Straight, Bulkhead Mount, Terminal	121
Straight, Panel Mount, Terminal	121
Reverse Polarity Straight, Bulkhead Mount, Terminal	122
Reverse Polarity Straight, Panel Mount, Terminal	122
BNC Twinax Jack Connectors	
Straight, Cable Connectors	135
Straight, Bulkhead Mount, Cable Connectors	135
Straight, Bulkhead Mount, Terminal	135
Straight, Panel Mount, Terminal	135
Straight, PCB Mount	136
Right Angle, PCB Mount	136
BNC Twinax Plug Connectors	
Straight, Cable Connectors	135
C Female Connectors	
Straight, Cable Connectors	125
Straight, Bulkhead Mount, Cable Connectors	125
Straight, Panel Mount, Cable Connectors	125
Straight, Bulkhead Mount, Terminal	125
Straight, Panel Mount, Terminal	125
C Male Connectors	
Straight, Cable Connectors	124
Right Angle, Cable Connectors	124
Straight, Bulkhead Mount, Terminal	125
Straight, Panel Mount, Terminal	125
D-Sub Contacts Plug Connectors	
Straight, Cable Connectors	117
Right Angle, Cable Connectors	117
Straight, PCB Mount	118
Right Angle, PCB Mount	118
D-Sub Contacts Receptacle Connectors	
Straight, Cable Connectors	118

Connector Type	Page
Right Angle, Cable Connectors	118
Straight, PCB Mount	118
Right Angle, PCB Mount	118
FAKRA Jack Connectors	
Straight, Cable Connectors	115
Right Angle, Cable Connectors	115
Right Angle, PCB Mount	116
FAKRA Plug Connectors	
Straight, Cable Connectors	115
Straight, PCB Mount	115
Right Angle, PCB Mount	116
FME Jack Connectors	
Straight, Cable Connectors	104
FME Plug Connectors	
Straight, Cable Connectors	104
Straight, Bulkhead Mount, Terminal	104
GR874 Sexless Connectors	
Straight, Cable Connectors	119
Straight	119
HN Female Connectors	
Straight, Cable Connectors	108
Straight, Bulkhead Mount, Terminal	108
Straight, Panel Mount, Terminal	108
HN Male Connectors	
Straight, Cable Connectors	107
Right Angle, Cable Connectors	108
LC Female Connectors	
Straight, Cable Connectors	107
Straight, Panel Mount, Terminal	107
LC Male Connectors	
Straight, Cable Connectors	107
Right Angle, Cable Connectors	107
MC-CARD Plug Connectors	
Straight, Cable Connectors	117
Right Angle, Cable Connectors	117
MCX Jack Connectors	
Straight, Cable Connectors	111
Straight, Bulkhead Mount, Cable Connectors	111
Reverse Polarity Straight, Bulkhead Mount, Cable Connectors	111
Straight, Bulkhead Mount, Terminal	112
Right Angle, Bulkhead Mount, Terminal	112
Straight, Panel Mount, Terminal	112
Straight, PCB Mount	112
Right Angle, PCB Mount	112
Reverse Polarity Straight, PCB Mount	112
Reverse Polarity Straight, Bulkhead Mount, PCB Mount	112
Reverse Polarity Right Angle, Bulkhead Mount, PCB Mount	112
MCX Plug Connectors	
Straight, Cable Connectors	111
Right Angle, Cable Connectors	111
Reverse Polarity Straight, Cable Connectors	111
Reverse Polarity Right Angle, Cable Connectors	111
Straight, PCB Mount	112
MHV Female Connectors	

Connector Locator

Connector Type	Page
Straight, Cable Connectors	123
Straight, Bulkhead Mount, Cable Connectors	123
Straight, Panel Mount, Cable Connectors	123
Straight, Bulkhead Mount, Terminal	123
Straight, Panel Mount, Terminal	123
MHV Male Connectors	
Straight, Cable Connectors	123
Right Angle, Cable Connectors	123
MINI SMP Female Connectors	
Straight, Cable Connectors	110
Right Angle, Cable Connectors	110
MINI SMP Male Connectors	
Straight, PCB Mount	110
MINI UHF Female Connectors	
Straight, Cable Connectors	103
Straight, Bulkhead Mount, Cable Connectors	103
Straight, Bulkhead Mount, Terminal	103
Straight, Panel Mount, Terminal	103
Straight, Bulkhead Mount, PCB Mount	103
MINI UHF Male Connectors	
Straight, Cable Connectors	103
Right Angle, Cable Connectors	103
MMCX Jack Connectors	
Straight, Cable Connectors	110
Straight, PCB Mount	111
Right Angle, PCB Mount	111
MMCX Plug Connectors	
Straight, Cable Connectors	110
Right Angle, Cable Connectors	110
Straight, PCB Mount	110
N Female Connectors	
Straight, Cable Connectors	95
Straight, Bulkhead Mount, Cable Connectors	96
Straight, Panel Mount, Cable Connectors	96
Reverse Polarity Straight, Cable Connectors	97
Straight, Bulkhead Mount, Terminal	97
Straight, Panel Mount, Terminal	97
Right Angle, Panel Mount, Terminal	97
Straight, Press In Mount, Terminal	97
Straight, PCB Mount	97
Straight, Bulkhead Mount, PCB Mount	98
Right Angle, Bulkhead Mount, PCB Mount	98
N Male Connectors	
Straight, Cable Connectors	94
Right Angle, Cable Connectors	95
Reverse Polarity Straight, Cable Connectors	97
Straight, Bulkhead Mount, Terminal	97
Straight, Panel Mount, Terminal	97
QMA Female Connectors	
Straight, Bulkhead Mount, Cable Connectors	108
Straight, PCB Mount	108
Right Angle, PCB Mount	108
QMA Male Connectors	
Straight, Cable Connectors	108
Right Angle, Cable Connectors	108

Connector Type	Page
QN Female Connectors	
Straight, Bulkhead Mount, Cable Connectors	109
Straight, Panel Mount, Terminal	109
QN Male Connectors	
Straight, Cable Connectors	109
Right Angle, Cable Connectors	109
RCA Jack Connectors	
Straight, Bulkhead Mount, Cable Connectors	135
RCA Plug Connectors	
Straight, Cable Connectors	134
Right Angle, Cable Connectors	135
SC Female Connectors	
Straight, Bulkhead Mount, Terminal	107
Straight, Panel Mount, Terminal	107
SC Male Connectors	
Straight, Cable Connectors	106
Right Angle, Cable Connectors	107
SHV Jack Connectors	
Straight, Bulkhead Mount, Cable Connectors	124
Straight, Bulkhead Mount, Terminal	124
Straight, Panel Mount, Terminal	124
SHV Plug Connectors	
Straight, Cable Connectors	124
Straight, Bulkhead Mount, Terminal	124
SMA Female Connectors	
Straight, Cable Connectors	84
Straight, Bulkhead Mount, Cable Connectors	84
Straight, Panel Mount, Cable Connectors	84
Reverse Polarity Straight, Cable Connectors	85
Reverse Polarity Straight, Bulkhead Mount, Cable Connectors	85
Reverse Thread Straight, Cable Connectors	86
Reverse Thread Straight, Bulkhead Mount, Cable Connectors	86
Straight, PCB Mount, Terminal	86
Right Angle, PCB Mount, Terminal	86
Straight, Bulkhead Mount, Terminal	87
Right Angle, Bulkhead Mount, Terminal	87
Straight, Panel Mount, Terminal	87
Right Angle, Panel Mount, Terminal	87
Straight, Press In Mount, Terminal	88
Reverse Polarity Straight, Bulkhead Mount, Terminal	88
Reverse Polarity Straight, Panel Mount, Terminal	88
Reverse Thread Straight, PCB Mount, Terminal	88
Reverse Thread Right Angle, PCB Mount, Terminal	88
Reverse Thread Straight, Panel Mount, Terminal	88
Straight, PCB Mount	88
Right Angle, PCB Mount	88
Straight, Bulkhead Mount, PCB Mount	89
Right Angle, Bulkhead Mount, PCB Mount	89
Reverse Polarity Straight, PCB Mount	89
Reverse Polarity Right Angle, PCB Mount	89
Reverse Polarity Straight, Bulkhead Mount, PCB Mount	89
Reverse Polarity Right Angle, Bulkhead Mount, PCB Mount	89
Reverse Thread Straight, PCB Mount	89
Straight, Panel Mount, Field Replaceable	90
Right Angle, Panel Mount, Field Replaceable	90

Connector Locator

Connector Type	Page
SMA Male Connectors	
Straight, Cable Connectors	83
Right Angle, Cable Connectors	83
Reverse Polarity Straight, Cable Connectors	85
Reverse Polarity Right Angle, Cable Connectors	85
Reverse Thread Straight, Cable Connectors	86
Reverse Thread Right Angle, Cable Connectors	86
Straight, Bulkhead Mount, Terminal	86
Straight, Panel Mount, Terminal	86
Straight, PCB Mount	88
Right Angle, PCB Mount	88
Reverse Polarity Straight, PCB Mount	89
Straight, Panel Mount, Field Replaceable	90
SMB Jack Connectors	
Straight, Cable Connectors	113
Straight, Bulkhead Mount, Cable Connectors	113
Straight, Bulkhead Mount, Terminal	113
Right Angle, Bulkhead Mount, Terminal	113
Straight, Panel Mount, Terminal	113
Straight, PCB Mount	114
Right Angle, PCB Mount	114
Straight, PCB Mount	114
Right Angle, PCB Mount	114
Straight, Bulkhead Mount, PCB Mount	114
Right Angle, Bulkhead Mount, PCB Mount	114
SMB Plug Connectors	
Straight, Cable Connectors	112
Right Angle, Cable Connectors	113
Straight, Bulkhead Mount, Terminal	113
Straight, PCB Mount	113
Right Angle, PCB Mount	113
SMC Jack Connectors	
Straight, Cable Connectors	104
Straight, Bulkhead Mount, Cable Connectors	104
Straight, Bulkhead Mount, Terminal	105
Right Angle, Bulkhead Mount, Terminal	105
Straight, Panel Mount, Terminal	105
Straight, PCB Mount	105
Right Angle, PCB Mount	105
Right Angle, Bulkhead Mount, PCB Mount	105
Right Angle, PCB Mount	105
Straight, Bulkhead Mount, PCB Mount	105
SMC Plug Connectors	
Straight, Cable Connectors	104
Right Angle, Cable Connectors	104
Straight, Bulkhead Mount, Terminal	105
Straight, PCB Mount	105
Right Angle, PCB Mount	105
SMP Female Connectors	
Straight, Cable Connectors	109
Right Angle, Cable Connectors	109
SMP Male Connectors	
Straight, Bulkhead Mount, Cable Connectors	109
Straight, PCB Mount	109
SSMA Female Connectors	

Connector Type	Page
Straight, Cable Connectors	93
Straight, Bulkhead Mount, Cable Connectors	93
Straight, Panel Mount, Cable Connectors	94
Straight, Bulkhead Mount, Terminal	94
Straight, Panel Mount, Terminal	94
Straight, PCB Mount	94
Right Angle, PCB Mount	94
SSMA Male Connectors	
Straight, Cable Connectors	93
Right Angle, Cable Connectors	93
Straight, Panel Mount, Terminal	94
Straight, PCB Mount	94
SSMB Jack Connectors	
Straight, Bulkhead Mount, Cable Connectors	114
Straight, Bulkhead Mount, Terminal	114
Straight, Panel Mount, Terminal	114
Straight, PCB Mount	115
Right Angle, PCB Mount	115
SSMB Plug Connectors	
Straight, Cable Connectors	114
Right Angle, Cable Connectors	114
TNC Female Connectors	
Straight, Cable Connectors	98
Straight, Bulkhead Mount, Cable Connectors	99
Straight, Panel Mount, Cable Connectors	99
Reverse Polarity Straight, Cable Connectors	99
Reverse Polarity Straight, Bulkhead Mount, Cable Connectors	100
Straight, Bulkhead Mount, Terminal	100
Right Angle, Bulkhead Mount, Terminal	100
Straight, Panel Mount, Terminal	100
Reverse Polarity Straight, Bulkhead Mount, Terminal	100
Reverse Polarity Straight, Panel Mount, Terminal	100
Right Angle, PCB Mount	101
TNC Male Connectors	
Straight, Cable Connectors	98
Right Angle, Cable Connectors	98
Reverse Polarity Straight, Cable Connectors	99
Reverse Polarity Right Angle, Cable Connectors	99
Straight, Panel Mount, Terminal	100
Reverse Polarity Straight, Panel Mount, Terminal	100
UHF Female Connectors	
Straight, Cable Connectors	102
Straight, Bulkhead Mount, Terminal	103
Straight, Panel Mount, Terminal	103
UHF Male Connectors	
Straight, Cable Connectors	102
UHF Sexless Connectors	
Straight, Accessories, Cable Connectors	103
UMCX Jack Connectors	
Straight, PCB Mount	110

SMA Connectors

Product Image	Attachment Cable/Contact	Coax Type / Termination Type	Model No.	Price				Row		
				1-24	25-49	50-99	100 +			
Male Straight, Cable Connectors										
	Crimp/Solder	RG8X, PE-C240	PE44637	\$15.05	\$14.00	\$12.94	\$12.04	1		
		RG188-DS, RG316-DS	PE4401	\$11.50	\$10.70	\$9.89	\$9.20	2		
		PE-C400	PE44668	\$20.42	\$18.99	\$17.56	\$16.34	3		
		PE-P195	PE44203	\$10.99	\$10.22	\$9.45	\$8.79	4		
		RG174, RG316, RG188	PE4003	\$12.26	\$11.40	\$10.54	\$9.81	5		
		RG178, RG196	PE4398	\$14.54	\$13.52	\$12.50	\$11.63	6		
		RG180, RG195	PE4578	\$17.63	\$16.40	\$15.16	\$14.10	7		
		RG58	PE4215	\$8.92	\$8.30	\$7.67	\$7.14	8		
		RG58, RG141, RG303, Quick Disconnect	PE44460	\$49.91	\$46.42	\$42.92	\$39.93	9		
		RG59, RG62	PE4294	\$20.06	\$18.66	\$17.25	\$16.05	10		
		RG55, RG142, RG223, RG400	PE4008	\$9.88	\$9.19	\$8.50	\$7.90	11		
	Crimp/Solder (Captive Contact)	RG174, RG316, RG188	PE4589	\$13.22	\$12.29	\$11.37	\$10.58	12		
		RG58	PE4577	\$16.65	\$15.48	\$14.32	\$13.32	13		
	Clamp/Solder	RG55, RG142, RG223, RG400	PE4576	\$18.62	\$17.32	\$16.01	\$14.90	14		
		RG188-DS, RG316-DS	PE4400	\$22.44	\$20.87	\$19.30	\$17.95	15		
	Clamp/Solder	PE-P195	PE4085	\$18.59	\$17.29	\$15.99	\$14.87	16		
		PE-SR401AL, PE-SR401FL, RG401, .250" Semi-Rigid	PE4403	\$33.60	\$31.25	\$28.90	\$26.88	17		
		RG174, RG316, RG188	PE4026	\$20.35	\$18.93	\$17.50	\$16.28	18		
		RG178, RG196	PE4214	\$36.99	\$34.40	\$31.81	\$29.59	19		
		RG180, RG195	PE4399	\$16.16	\$15.03	\$13.90	\$12.93	20		
		RG213, RG214, RG8, RG9, RG225, RG393, RG11	PE4332	\$59.18	\$55.04	\$50.89	\$47.34	21		
		RG58, RG55, RG142, RG223, RG400	PE4027	\$20.67	\$19.22	\$17.78	\$16.54	22		
		RG188-DS, RG316-DS	PE4402	\$11.70	\$10.88	\$10.06	\$9.36	23		
		PE-020SR, .020" Semi-Rigid	PE4918	\$31.92	\$29.69	\$27.45	\$25.54	24		
		PE-034SR, .034" Semi-Rigid	PE4917	\$39.72	\$36.94	\$34.16	\$31.78	25		
		PE-047SR, PE-SR047AL, PE-SR047FL, .047" Semi-Rigid	PE4404	\$20.19	\$18.78	\$17.36	\$16.15	26		
PE-SR401AL, PE-SR401FL, RG401, .250" Semi-Rigid	PE4907	\$35.26	\$32.79	\$30.32	\$28.21	27				
PE-SR402AL, PE-SR402FL, RG402, .141" Semi-Rigid	PE4112	\$7.50	\$6.98	\$6.45	\$6.00	28				
PE-SR405AL, PE-SR405FL, RG405, .085" Semi-Rigid	PE4005	\$6.71	\$6.24	\$5.77	\$5.37	29				
	Solder/Solder	RG174, RG316, RG188	PE4036	\$10.28	\$9.56	\$8.84	\$8.22	30		
		RG178, RG196	PE4213	\$14.10	\$13.11	\$12.13	\$11.28	31		
		RG58, RG55, RG142, RG223, RG400	PE4037	\$12.00	\$11.16	\$10.32	\$9.60	32		
		PE-SR402AL, PE-SR402FL, RG402, .141" Semi-Rigid	PE4007	\$6.45	\$6.00	\$5.55	\$5.16	33		
	Solder/Solder (Captive Contact)	RG174, RG316, RG188	PE4590	\$12.95	\$12.04	\$11.14	\$10.36	34		
		RG58, RG55, RG142, RG223, RG400	PE4587	\$13.65	\$12.69	\$11.74	\$10.92	35		
Male Right Angle, Cable Connectors										
	Crimp/Solder	RG8X, PE-C240	PE44638	\$23.61	\$21.96	\$20.30	\$18.89	36		
		RG188-DS, RG316-DS	PE4408	\$16.97	\$15.78	\$14.59	\$13.58	37		
		RG178, RG196	PE4296	\$20.82	\$19.36	\$17.91	\$16.66	38		
		RG180, RG195	PE4580	\$18.39	\$17.10	\$15.82	\$14.71	39		
		RG316, RG174, RG188	PE4009	\$14.69	\$13.66	\$12.63	\$11.75	40		
		RG58	PE4405	\$14.54	\$13.52	\$12.50	\$11.63	41		
		RG59, RG62	PE4327	\$24.57	\$22.85	\$21.13	\$19.66	42		
		RG55, RG142, RG223, RG400	PE4002	\$14.69	\$13.66	\$12.63	\$11.75	43		
			Clamp/Solder	RG188-DS, RG316-DS	PE4407	\$23.41	\$21.77	\$20.13	\$18.73	44
				RG178, RG196	PE4108	\$15.60	\$14.51	\$13.42	\$12.48	45
				RG180, RG195	PE4579	\$19.40	\$18.04	\$16.68	\$15.52	46
RG316, RG174, RG188	PE4028			\$23.66	\$22.00	\$20.35	\$18.93	47		
RG58, RG55, RG142, RG223, RG400	PE4029			\$20.87	\$19.41	\$17.95	\$16.70	48		
	Solder/Solder	RG188-DS, RG316-DS	PE4409	\$16.45	\$15.30	\$14.15	\$13.16	49		
		PE-020SR, .020" Semi-Rigid	PE4920	\$46.05	\$42.83	\$39.60	\$36.84	50		
		PE-034SR, .034" Semi-Rigid	PE4919	\$41.14	\$38.26	\$35.38	\$32.91	51		
		PE-047SR, PE-SR047AL, PE-SR047FL, .047" Semi-Rigid	PE4410	\$45.35	\$42.18	\$39.00	\$36.28	52		
		PE-SR401AL, PE-SR401FL, RG401, .250" Semi-Rigid	PE4932	\$41.80	\$38.87	\$35.95	\$33.44	53		
		PE-SR402AL, PE-SR402FL, RG402, .141" Semi-Rigid	PE4083	\$21.61	\$20.10	\$18.58	\$17.29	54		
		PE-SR405AL, PE-SR405FL, RG405, .085" Semi-Rigid	PE4025	\$22.14	\$20.59	\$19.04	\$17.71	55		
		RG178, RG196	PE4406	\$18.80	\$17.48	\$16.17	\$15.04	56		

Connectors

See Our Website For Real-Time Stock Availability!

SMA Connectors

Connectors





See Our Website For Real-Time Stock Availability!

Product Image	Attachment Cable/Contact	Coax Type / Termination Type	Model No.	Price				Row
				1-24	25-49	50-99	100 +	
	Solder/Solder	RG316, RG174, RG188	PE4038	\$14.10	\$13.11	\$12.13	\$11.28	1
		RG58, RG55, RG142, RG223, RG400	PE4039	\$14.10	\$13.11	\$12.13	\$11.28	2

Female Straight, Cable Connectors

	Crimp/Solder	RG8X, PE-C240	PE44639	\$17.12	\$15.92	\$14.72	\$13.70	3
		RG188-DS, RG316-DS	PE4416	\$14.75	\$13.72	\$12.69	\$11.80	4
		PE-C400	PE44669	\$34.35	\$31.95	\$29.54	\$27.48	5
		RG178, RG196	PE4325	\$20.67	\$19.22	\$17.78	\$16.54	6
		RG316, RG174, RG188	PE4414	\$15.89	\$14.78	\$13.67	\$12.71	7
		RG58	PE4413	\$14.75	\$13.72	\$12.69	\$11.80	8
	Clamp/Solder	RG59, RG62	PE4326	\$21.58	\$20.07	\$18.56	\$17.26	9
		RG55, RG142, RG223, RG400	PE4412	\$12.16	\$11.31	\$10.46	\$9.73	10
		RG188-DS, RG316-DS	PE4415	\$22.34	\$20.78	\$19.21	\$17.87	11
		RG178, RG196	PE4591	\$22.34	\$20.78	\$19.21	\$17.87	12
		RG213, RG214, RG8, RG9, RG225, RG393, RG11	PE4411	\$43.52	\$40.47	\$37.43	\$34.82	13
		RG316, RG174, RG188	PE4030	\$22.34	\$20.78	\$19.21	\$17.87	14
		RG58, RG55, RG142, RG223, RG400	PE4031	\$31.11	\$28.93	\$26.75	\$24.89	15
		RG188-DS, RG316-DS	PE4417	\$12.95	\$12.04	\$11.14	\$10.36	16
		PE-020SR, .020" Semi-Rigid	PE4922	\$45.24	\$42.07	\$38.91	\$36.19	17
		PE-034SR, .034" Semi-Rigid	PE4921	\$41.14	\$38.26	\$35.38	\$32.91	18
	Solder/Solder	PE-047SR, PE-SR047AL, PE-SR047FL, .047" Semi-Rigid	PE4418	\$26.75	\$24.88	\$23.01	\$21.40	19
		PE-SR401AL, PE-SR401FL, RG401, .250" Semi-Rigid	PE4930	\$20.52	\$19.08	\$17.65	\$16.42	20
		PE-SR402AL, PE-SR402FL, RG402, .141" Semi-Rigid	PE4115	\$10.80	\$10.04	\$9.29	\$8.64	21
		PE-SR405AL, PE-SR405FL, RG405, .085" Semi-Rigid	PE4116	\$17.78	\$16.54	\$15.29	\$14.22	22
		RG178, RG196	PE4592	\$17.65	\$16.41	\$15.18	\$14.12	23
		RG316, RG174, RG188	PE4040	\$11.70	\$10.88	\$10.06	\$9.36	24
		RG58, RG55, RG142, RG223, RG400	PE4041	\$11.70	\$10.88	\$10.06	\$9.36	25

Female Straight, Bulkhead Mount, Cable Connectors

	Crimp/Solder	RG188-DS, RG316-DS, B02 Mounting Hole	PE4425	\$17.05	\$15.86	\$14.66	\$13.64	26		
		RG178, RG196, w/o-ring, B02 Mounting Hole	PE44657	\$12.87	\$11.97	\$11.07	\$10.30	27		
		RG178, RG196, B02 Mounting Hole	PE4422	\$20.87	\$19.41	\$17.95	\$16.70	28		
		RG316, RG174, RG188, B02 Mounting Hole	PE4427	\$15.20	\$14.14	\$13.07	\$12.16	29		
		RG58, B02 Mounting Hole	PE4420	\$14.35	\$13.35	\$12.34	\$11.48	30		
		RG59, RG62, B02 Mounting Hole	PE4914	\$20.77	\$19.32	\$17.86	\$16.62	31		
	Crimp/Solder (Captive Contact)	RG55, RG142, RG223, RG400, B02 Mounting Hole	PE4419	\$15.00	\$13.95	\$12.90	\$12.00	32		
		RG316, RG174, RG188, B02 Mounting Hole	PE4187	\$15.66	\$14.56	\$13.47	\$12.53	33		
			Clamp/Solder	RG188-DS, RG316-DS, B02 Mounting Hole	PE4424	\$31.00	\$28.83	\$26.66	\$24.80	34
				RG178, RG196, B02 Mounting Hole	PE4421	\$22.29	\$20.73	\$19.17	\$17.83	35
				RG316, RG174, RG188, B02 Mounting Hole	PE4032	\$25.65	\$23.85	\$22.06	\$20.52	36
				RG58, RG55, RG142, RG223, B02 Mounting Hole	PE4033	\$26.95	\$25.06	\$23.18	\$21.56	37
			Solder/Solder	RG188-DS, RG316-DS, B02 Mounting Hole	PE4426	\$15.35	\$14.28	\$13.20	\$12.28	38
				PE-020SR, B02 Mounting Hole, .020" Semi-Rigid	PE4924	\$45.55	\$42.36	\$39.17	\$36.44	39
				PE-034SR, B02 Mounting Hole, .034" Semi-Rigid	PE4923	\$47.37	\$44.05	\$40.74	\$37.90	40
				PE-047SR, PE-SR047AL, PE-SR047FL, B02 Mounting Hole, .047" Semi-Rigid	PE4581	\$36.83	\$34.25	\$31.67	\$29.46	41
PE-SR401AL, PE-SR401FL, RG401, B02 Mounting Hole, .250" Semi-Rigid	PE4931			\$27.92	\$25.97	\$24.01	\$22.34	42		
PE-SR402AL, PE-SR402FL, RG402, B02 Mounting Hole, .141" Semi-Rigid	PE4120			\$11.49	\$10.69	\$9.88	\$9.19	43		
PE-SR405AL, PE-SR405FL, RG405, B02 Mounting Hole, .085" Semi-Rigid	PE4119			\$14.58	\$13.56	\$12.54	\$11.66	44		
RG178, RG196, B02 Mounting Hole	PE4423			\$20.05	\$18.65	\$17.24	\$16.04	45		
	Solder/Solder (Captive Contact)	RG316, RG174, RG188, B02 Mounting Hole	PE4188	\$14.10	\$13.11	\$12.13	\$11.28	46		
		RG58, RG55, RG142, RG223, B02 Mounting Hole	PE4353	\$14.45	\$13.44	\$12.43	\$11.56	47		
		RG316, RG174, RG188, B02 Mounting Hole	PE4428	\$15.65	\$14.55	\$13.46	\$12.52	48		

Female Straight, Panel Mount, Cable Connectors

	Solder/Solder	2 Hole Flange, PE-047SR, PE-SR047AL, PE-SR047FL, C01 Mounting Hole, .047" Semi-Rigid	PE4547	\$20.06	\$18.66	\$17.25	\$16.05	49
		2 Hole Flange, PE-SR402AL, PE-SR402FL, RG402, C02 Mounting Hole, .141" Semi-Rigid	PE4196	\$19.51	\$18.14	\$16.78	\$15.61	50
		2 Hole Flange, PE-SR405AL, PE-SR405FL, RG405, C03 Mounting Hole, .085" Semi-Rigid	PE4197	\$17.63	\$16.40	\$15.16	\$14.10	51

SMA Connectors

Product Image	Attachment Cable/Contact	Coax Type / Termination Type	Model No.	Price				Row
				1-24	25-49	50-99	100 +	
	Clamp/Solder	4 Hole Flange, RG316, RG174, RG188, A01 Mounting Hole	PE4034	\$43.52	\$40.47	\$37.43	\$34.82	1
		4 Hole Flange, RG58, RG55, RG141, RG142, RG400, RG223, A01 Mounting Hole	PE4035	\$43.52	\$40.47	\$37.43	\$34.82	2
	Solder/Solder	4 Hole Flange, PE-047SR, PE-SR047AL, PE-SR047FL, A01 Mounting Hole, .047" Semi-Rigid	PE4548	\$28.73	\$26.72	\$24.71	\$22.98	3
		4 Hole Flange, PE-SR402AL, PE-SR402FL, RG402, A01 Mounting Hole, .141" Semi-Rigid	PE4121	\$25.49	\$23.71	\$21.92	\$20.39	4
		4 Hole Flange, PE-SR405AL, PE-SR405FL, RG405, A01 Mounting Hole, .085" Semi-Rigid	PE4122	\$22.45	\$20.88	\$19.31	\$17.96	5

Reverse Polarity Male Straight, Cable Connectors

	Crimp/Solder	RG8X, PE-C240	PE44664	\$19.25	\$17.90	\$16.56	\$15.40	6
		PE-B400, PE-B405, PE-C400, .400 inch	PE44666	\$23.61	\$21.96	\$20.30	\$18.89	7
		RG174, RG316, RG188	PE4771	\$14.08	\$13.09	\$12.11	\$11.26	8
		RG178, RG196	PE4774	\$22.34	\$20.78	\$19.21	\$17.87	9
		RG180, RG195	PE4777	\$23.66	\$22.00	\$20.35	\$18.93	10
		RG58	PE4769	\$17.00	\$15.81	\$14.62	\$13.60	11
	Clamp/Solder	RG55, RG141, RG142, RG223, RG400	PE4767	\$14.84	\$13.80	\$12.76	\$11.87	12
		RG174, RG316, RG188	PE4770	\$24.88	\$23.14	\$21.40	\$19.90	13
		RG178, RG196	PE4773	\$22.34	\$20.78	\$19.21	\$17.87	14
		RG180, RG195	PE4776	\$22.34	\$20.78	\$19.21	\$17.87	15
		RG58, RG55, RG141, RG142, RG223, RG400	PE4766	\$24.88	\$23.14	\$21.40	\$19.90	16
		PE-SR402AL, PE-SR402FL, RG402, .141" Semi-Rigid	PE4778	\$18.59	\$17.29	\$15.99	\$14.87	17
	Solder/Solder	PE-SR405AL, PE-SR405FL, RG405, .085" Semi-Rigid	PE4779	\$18.59	\$17.29	\$15.99	\$14.87	18
		RG174, RG316, RG188	PE4772	\$16.65	\$15.48	\$14.32	\$13.32	19
		RG178, RG196	PE4775	\$16.35	\$15.21	\$14.06	\$13.08	20
		RG58, RG55, RG141, RG142, RG223, RG400	PE4768	\$16.65	\$15.48	\$14.32	\$13.32	21

Reverse Polarity Male Right Angle, Cable Connectors

	Crimp/Solder	RG174, RG316, RG188	PE4785	\$31.11	\$28.93	\$26.75	\$24.89	22
		RG178, RG196	PE4788	\$31.11	\$28.93	\$26.75	\$24.89	23
		RG58	PE4783	\$26.20	\$24.37	\$22.53	\$20.96	24
	Clamp/Solder	RG55, RG141, RG142, RG223, RG400	PE4781	\$29.39	\$27.33	\$25.28	\$23.51	25
		RG174, RG316, RG188	PE4784	\$37.34	\$34.73	\$32.11	\$29.87	26
		RG178, RG196	PE4787	\$76.35	\$71.01	\$65.66	\$61.08	27
	Solder/Solder	RG58, RG55, RG141, RG142, RG223, RG400	PE4780	\$31.11	\$28.93	\$26.75	\$24.89	28
		PE-SR402AL, PE-SR402FL, RG402, .141" Semi-Rigid	PE4790	\$31.11	\$28.93	\$26.75	\$24.89	29
		PE-SR405AL, PE-SR405FL, RG405, .085" Semi-Rigid	PE4791	\$31.11	\$28.93	\$26.75	\$24.89	30
		RG174, RG316, RG188	PE4786	\$27.90	\$25.95	\$23.99	\$22.32	31
		RG178, RG196	PE4789	\$31.11	\$28.93	\$26.75	\$24.89	32
		RG58, RG55, RG141, RG142, RG400, RG223	PE4782	\$27.90	\$25.95	\$23.99	\$22.32	33

Reverse Polarity Female Straight, Cable Connectors

	Crimp/Solder	RG8X, PE-C240	PE44665	\$20.42	\$18.99	\$17.56	\$16.34	34
		PE-C400	PE44667	\$24.67	\$22.94	\$21.22	\$19.74	35
		RG174, RG316, RG188	PE4797	\$21.13	\$19.65	\$18.17	\$16.90	36
		RG178, RG196	PE4799	\$22.34	\$20.78	\$19.21	\$17.87	37
		RG58	PE4795	\$20.50	\$19.07	\$17.63	\$16.40	38
		RG55, RG141, RG142, RG223, RG400	PE4793	\$23.66	\$22.00	\$20.35	\$18.93	39
	Clamp/Solder	RG174, RG316, RG188	PE4796	\$24.88	\$23.14	\$21.40	\$19.90	40
		RG178, RG196	PE4850	\$24.88	\$23.14	\$21.40	\$19.90	41
		RG58, RG55, RG141, RG142, RG400, RG223	PE4792	\$24.88	\$23.14	\$21.40	\$19.90	42
	Solder/Solder	PE-SR402AL, PE-SR402FL, RG402, .141" Semi-Rigid	PE4852	\$23.66	\$22.00	\$20.35	\$18.93	43
		PE-SR405AL, PE-SR405FL, RG405, .085" Semi-Rigid	PE4853	\$23.66	\$22.00	\$20.35	\$18.93	44
		RG174, RG316, RG188	PE4798	\$20.50	\$19.07	\$17.63	\$16.40	45
		RG178, RG196	PE4851	\$20.10	\$18.69	\$17.29	\$16.08	46
		RG58, RG55, RG141, RG142, RG400, RG223	PE4794	\$20.10	\$18.69	\$17.29	\$16.08	47

Reverse Polarity Female Straight, Bulkhead Mount, Cable Connectors

	Crimp/Solder	RG174, RG316, RG188, B02 Mounting Hole	PE4859	\$20.67	\$19.22	\$17.78	\$16.54	48
		RG178, RG196, B02 Mounting Hole	PE4862	\$21.13	\$19.65	\$18.17	\$16.90	49
		RG58, B02 Mounting Hole	PE4857	\$19.30	\$17.95	\$16.60	\$15.44	50
		RG55, RG141, RG142, RG223, RG400, B02 Mounting Hole	PE4855	\$19.96	\$18.56	\$17.17	\$15.97	51
	Clamp/Solder	RG174, RG316, RG188, B02 Mounting Hole	PE4858	\$31.11	\$28.93	\$26.75	\$24.89	52
		RG178, RG196, B02 Mounting Hole	PE4861	\$31.11	\$28.93	\$26.75	\$24.89	53
		RG58, RG55, RG141, RG142, RG400, RG223, B02 Mounting Hole	PE4854	\$31.11	\$28.93	\$26.75	\$24.89	54









Connectors

See Our Website For Real-Time Stock Availability!

SMA Connectors





Connectors

See Our Website For Real-Time Stock Availability!

Product Image	Attachment Cable/Contact	Coax Type / Termination Type	Model No.	Price				Row
				1-24	25-49	50-99	100 +	
	Solder/Solder	PE-SR402AL, PE-SR402FL, RG402, B02 Mounting Hole, .141" Semi-Rigid	PE4864	\$26.14	\$24.31	\$22.48	\$20.91	1
		PE-SR405AL, PE-SR405FL, RG405, B02 Mounting Hole, .085" Semi-Rigid	PE4865	\$27.36	\$25.44	\$23.53	\$21.89	2
		RG174, RG316, RG188, B02 Mounting Hole	PE4860	\$20.10	\$18.69	\$17.29	\$16.08	3
		RG178, RG196, B02 Mounting Hole	PE4863	\$21.20	\$19.72	\$18.23	\$16.96	4
		RG58, RG55, RG141, RG142, RG400, RG223, B02 Mounting Hole	PE4856	\$20.10	\$18.69	\$17.29	\$16.08	5
Reverse Thread Male Straight, Cable Connectors								
	Crimp/Solder	RG174, RG316, RG188	PE44184	\$18.59	\$17.29	\$15.99	\$14.87	6
		RG178, RG196	PE44185	\$18.59	\$17.29	\$15.99	\$14.87	7
		RG58	PE44183	\$17.00	\$15.81	\$14.62	\$13.60	8
		RG55, RG141, RG142, RG223, RG400	PE44182	\$18.59	\$17.29	\$15.99	\$14.87	9
Reverse Thread Male Right Angle, Cable Connectors								
	Crimp/Solder	RG174, RG316, RG188	PE44188	\$32.37	\$30.10	\$27.84	\$25.90	10
		RG178, RG196	PE44189	\$32.37	\$30.10	\$27.84	\$25.90	11
		RG58	PE44187	\$29.55	\$27.48	\$25.41	\$23.64	12
		RG55, RG141, RG142, RG223, RG400	PE44186	\$32.37	\$30.10	\$27.84	\$25.90	13
Reverse Thread Female Straight, Cable Connectors								
	Crimp/Solder	RG174, RG316, RG188	PE44192	\$21.13	\$19.65	\$18.17	\$16.90	14
		RG178, RG196	PE44193	\$21.13	\$19.65	\$18.17	\$16.90	15
		RG58	PE44191	\$20.50	\$19.07	\$17.63	\$16.40	16
		RG55, RG141, RG142, RG223, RG400	PE44190	\$21.13	\$19.65	\$18.17	\$16.90	17
Reverse Thread Female Straight, Bulkhead Mount, Cable Connectors								
	Crimp/Solder	RG174, RG316, RG188, B02 Mounting Hole	PE44196	\$24.88	\$23.14	\$21.40	\$19.90	18
		RG178, RG196, B02 Mounting Hole	PE44197	\$24.88	\$23.14	\$21.40	\$19.90	19
		RG58, B02 Mounting Hole	PE44195	\$22.30	\$20.74	\$19.18	\$17.84	20
		RG55, RG141, RG142, RG223, RG400, B02 Mounting Hole	PE44194	\$24.88	\$23.14	\$21.40	\$19.90	21
Male Straight, Bulkhead Mount, Terminal								
	Solder	Solder Cup Contact, Front Mount, .125" Max Panel, .380" x .350" Mounting Hole Size, B04 Mounting Hole	PE4544	\$20.77	\$19.32	\$17.86	\$16.62	22
		Solder Cup Contact, Front Mount, .125" Max Panel, .250" x .235" Mounting Hole Size, B02 Mounting Hole	PE4354	\$14.14	\$13.15	\$12.16	\$11.31	23
		.020" Dia. Stub Contact, Front Mount, Hermetically Sealed w/o-ring, F01 Mounting Hole	PE4531	\$28.73	\$26.72	\$24.71	\$22.98	24
Male Straight, Panel Mount, Terminal								
	Solder	2 Hole Flange, .050" Stub Contact, .330" Extended Dielectric, C02 Mounting Hole	PE4127	\$18.59	\$17.29	\$15.99	\$14.87	25
		2 Hole Flange, Solder Cup Contact, C01 Mounting Hole	PE4125	\$20.27	\$18.85	\$17.43	\$16.22	26
		4 Hole Flange, .050" Stub Contact, .330" Extended Dielectric, A01 Mounting Hole	PE4126	\$17.18	\$15.98	\$14.77	\$13.74	27
		4 Hole Flange, Solder Cup Contact, A01 Mounting Hole	PE4124	\$17.63	\$16.40	\$15.16	\$14.10	28
		4 Hole Flange, .020" Dia Stub Contact, Hermetically Sealed w/o-ring, A01 Mounting Hole	PE4541	\$37.34	\$34.73	\$32.11	\$29.87	29
Female Straight, PCB Mount, Terminal								
	Solder	Stripline End Launch, 1/16" Ground Plane Spacing, Captive Tab Contact	PE4534	\$33.13	\$30.81	\$28.49	\$26.50	30
		Stripline End Launch, 1/4" Ground Plane Spacing, Captive Tab Contact	PE4535	\$46.31	\$43.07	\$39.83	\$37.05	31
		Stripline End Launch, 1/8" Ground Plane Spacing, Captive Tab Contact	PE4190	\$34.86	\$32.42	\$29.98	\$27.89	32
		.050" Dia. Contact, .155" Leg Length, D01 Mounting Hole	PE4117	\$12.59	\$11.71	\$10.83	\$10.07	33
Female Right Angle, PCB Mount, Terminal								
	Solder	.050" Dia. Contact, .155" Leg Length, D01 Mounting Hole	PE4118	\$14.74	\$13.71	\$12.68	\$11.79	34

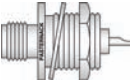
Yottahertz (YHz) = 10²⁴ Hertz or One Septillion Hertz.

SMA Connectors

Product Image	Attachment Cable/Contact	Coax Type / Termination Type	Model No.	Price				Row
				1-24	25-49	50-99	100 +	
Female Straight, Bulkhead Mount, Terminal								
	Solder	.050" Dia. Stub Contact, 27 GHz Precision, Max VSWR 1.20:1, F01 Mounting Hole	PE44344	\$37.34	\$34.73	\$32.11	\$29.87	1
		.050" Dia. Stub Contact, F01 Mounting Hole	PE4189	\$10.99	\$10.22	\$9.45	\$8.79	2
		Solder Cup Contact, Front Mount, .250" Max Panel, B04 Mounting Hole	PE4536	\$47.98	\$44.62	\$41.26	\$38.38	3
		Solder Cup Contact, Rear Mount, w/o-ring, .093" Max Panel, B02 Mounting Hole	PE4529	\$16.82	\$15.64	\$14.47	\$13.46	4
		Solder Cup Contact, Rear Mount, .160" Max Panel, B02 Mounting Hole	PE4101	\$10.94	\$10.17	\$9.41	\$8.75	5
		Solder Cup Contact, Front Mount, .125" Max Panel, B02 Mounting Hole	PE4219	\$9.91	\$9.22	\$8.52	\$7.93	6
		Solder Cup Contact, F01 Mounting Hole	PE4549	\$15.60	\$14.51	\$13.42	\$12.48	7
		.020" Dia. Stub Contact, Rear Mount, Hermetically Sealed w/o-ring, .125" Max Panel, B02 Mounting Hole	PE4528	\$24.57	\$22.85	\$21.13	\$19.66	8
		.020" Dia. Stub Contact, Hermetically Sealed, F01 Mounting Hole	PE4532	\$19.96	\$18.56	\$17.17	\$15.97	9
.020" Dia. Stub Contact, Front Mount, Hermetically Sealed w/o-ring, F01 Mounting Hole	PE4530	\$24.67	\$22.94	\$21.22	\$19.74	10		
Female Right Angle, Bulkhead Mount, Terminal								
	Solder	Solder Cup Contact, .125" Max Panel, B02 Mounting Hole	PE4300	\$37.34	\$34.73	\$32.11	\$29.87	11
Female Straight, Panel Mount, Terminal								
	Solder	2 Hole Flange, .010" Stub Contact, .125" Extended Dielectric, C01 Mounting Hole	PE4001	\$13.37	\$12.43	\$11.50	\$10.70	12
		2 Hole Flange, .050" Stub Contact, .590" Extended Dielectric, 27 GHz Precision, Max VSWR: 1.20:1, C01 Mounting Hole	PE44343	\$37.64	\$35.01	\$32.37	\$30.11	13
		2 Hole Flange, .050" Stub Contact, .590" Extended Dielectric, .625" Flange Size, C01 Mounting Hole	PE4128	\$13.88	\$12.91	\$11.94	\$11.10	14
		2 Hole Flange, Removable Tab Contact, Flush Dielectric, C01 Mounting Hole	PE4370	\$18.59	\$17.29	\$15.99	\$14.87	15
		2 Hole Flange, Solder Cup Contact, 27 GHz Precision, Max VSWR 1.20:1, C01 Mounting Hole	PE44341	\$37.34	\$34.73	\$32.11	\$29.87	16
		2 Hole Flange, Solder Cup Contact, .625" Flange Size, C01 Mounting Hole	PE4004	\$11.75	\$10.93	\$10.11	\$9.40	17
		2 Hole Flange, .010" Stub Contact, .125" Extended Dielectric, 27 GHz Precision, Max VSWR: 1.20:1, C01 Mounting Hole	PE44340	\$47.37	\$44.05	\$40.74	\$37.90	18
		4 Hole Flange, .050" Stub Contact, .590" Extended Dielectric, .687" Flange Size, A04 Mounting Hole	PE4533	\$18.39	\$17.10	\$15.82	\$14.71	19
		4 Hole Flange, .050" Stub Contact, .590" Extended Dielectric, .500" Flange Size, A01 Mounting Hole	PE4099	\$12.11	\$11.26	\$10.41	\$9.69	20
		4 Hole Flange, Removable Tab Contact, Flush Dielectric, .500" x .375" Flange Mount, E01 Mounting Hole	PE4539	\$23.66	\$22.00	\$20.35	\$18.93	21
		4 Hole Flange, Removable Tab Contact, Flush Dielectric, 1" Flange Size, A05 Mounting Hole	PE4546	\$32.07	\$29.83	\$27.58	\$25.66	22
		4 Hole Flange, Removable Tab Contact, Flush Dielectric, A01 Mounting Hole	PE4186	\$11.75	\$10.93	\$10.11	\$9.40	23
		4 Hole Flange, .012" Width Slot in Contact, 1" Flange Size, A05 Mounting Hole	PE4216	\$21.13	\$19.65	\$18.17	\$16.90	24
		4 Hole Flange, .050" Stub Contact, .590" Extended Dielectric, .375" x .500" Flange Size, E01 Mounting Hole	PE4538	\$30.85	\$28.69	\$26.53	\$24.68	25
		4 Hole Flange, .012" Width Slot in Contact, .500" Flange Size, A01 Mounting Hole	PE4217	\$15.30	\$14.23	\$13.16	\$12.24	26
		4 Hole Flange, Solder Cup Contact, .500" Flange Size, A01 Mounting Hole	PE4000	\$15.50	\$14.42	\$13.33	\$12.40	27
		4 Hole Flange, Solder Cup Contact, .500" x .375" Flange Size, E01 Mounting Hole	PE4537	\$23.66	\$22.00	\$20.35	\$18.93	28
		4 Hole Flange, Solder Cup Contact, 1" Flange Size, A05 Mounting Hole	PE4218	\$18.59	\$17.29	\$15.99	\$14.87	29
		4 Hole Flange, Solder Cup Contact, .687" Flange Size, A04 Mounting Hole	PE4527	\$18.59	\$17.29	\$15.99	\$14.87	30
		4 Hole Flange, .020" Stub Contact, Hermetically Sealed w/o-ring, A01 Mounting Hole	PE4540	\$33.84	\$31.47	\$29.10	\$27.07	31
Female Right Angle, Panel Mount, Terminal								
	Solder	2 Hole Flange, .050" Dia. Stub Contact, .250" Extended Dielectric, 90° Flange Direction, C01 Mounting Hole	PE44593	\$34.86	\$32.42	\$29.98	\$27.89	32
		2 Hole Flange, .050" Dia. Stub Contact, .590" Extended Dielectric, -45° Flange Direction, C01 Mounting Hole	PE44239	\$34.86	\$32.42	\$29.98	\$27.89	33
		2 Hole Flange, .050" Dia. Stub Contact, .590" Extended Dielectric, +45° Flange Direction, C01 Mounting Hole	PE44238	\$34.86	\$32.42	\$29.98	\$27.89	34
		2 Hole Flange, .050" Dia. Stub Contact, .590" Extended Dielectric, 90° Flange Direction, C01 Mounting Hole	PE44237	\$41.90	\$38.97	\$36.03	\$33.52	35
		Radius 4 Hole Flange, Solder Cup Contact, .500" Flange Size, A01 Mounting Hole	PE4220	\$52.13	\$48.48	\$44.83	\$41.70	36
		4 Hole Flange, .050" Dia. Contact, .590" Extended Dielectric, A01 Mounting Hole	PE44236	\$34.04	\$31.66	\$29.27	\$27.23	37
		4 Hole Flange, Solder Cup Contact, A01 Mounting Hole	PE4123	\$28.93	\$26.90	\$24.88	\$23.14	38

Connectors











See Our Website For Real-Time Stock Availability!





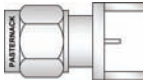

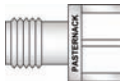
SMA Connectors

Connectors

See Our Website For Real-Time Stock Availability!

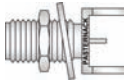
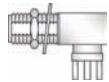
Product Image	Attachment Cable/Contact	Coax Type / Termination Type	Model No.	Price				Row
				1-24	25-49	50-99	100 +	
Female Straight, Press In Mount, Terminal								
	Solder	.010" X .020" Tab Contact, F07 Mounting Hole	PE44240	\$21.13	\$19.65	\$18.17	\$16.90	1
		.030" Dia Contact, F07 Mounting Hole	PE44241	\$21.13	\$19.65	\$18.17	\$16.90	2
Reverse Polarity Female Straight, Bulkhead Mount, Terminal								
	Solder	Solder Cup Contact, Front Mount, .125" Max Panel, B02 Mounting Hole	PE4871	\$17.63	\$16.40	\$15.16	\$14.10	3
		Solder Cup Contact, Rear Mount, .150" Max Panel, B02 Mounting Hole	PE4868	\$16.16	\$15.03	\$13.90	\$12.93	4
Reverse Polarity Female Straight, Panel Mount, Terminal								
	Solder	2 Hole Flange, Solder Cup Contact, .625" Flange Size, C01 Mounting Hole	PE4867	\$19.91	\$18.52	\$17.12	\$15.93	5
		4 Hole Flange, Solder Cup Contact, .500" Flange Size, A01 Mounting Hole	PE4866	\$18.59	\$17.29	\$15.99	\$14.87	6
Reverse Thread Female Straight, PCB Mount, Terminal								
	Solder	.050" Dia. Contact, .155" Leg Length, D01 Mounting Hole	PE44198	\$21.13	\$19.65	\$18.17	\$16.90	7
Reverse Thread Female Right Angle, PCB Mount, Terminal								
	Solder	.050" Dia. Contact, .155" Leg Length, D01 Mounting Hole	PE44199	\$23.66	\$22.00	\$20.35	\$18.93	8
Reverse Thread Female Straight, Panel Mount, Terminal								
	Solder	4 Hole Flange, Solder Cup Contact, .500" Flange Size, A01 Mounting Hole	PE44200	\$23.66	\$22.00	\$20.35	\$18.93	9
Male Straight, PCB Mount								
	Solder	End Launch, .042" Board Thickness, .020" x .010" Tab Contact	PE44210	\$24.83	\$23.09	\$21.35	\$19.86	10
		End Launch, .042" Board Thickness, .030" Round Contact	PE44209	\$23.05	\$21.44	\$19.82	\$18.44	11
		End Launch, .062" Board Thickness, .020" x .010" Tab Contact	PE4913	\$22.34	\$20.78	\$19.21	\$17.87	12
		End Launch, .062" Board Thickness, .030" Round Contact	PE4912	\$21.13	\$19.65	\$18.17	\$16.90	13
		.050" Dia. Contact, .155" Leg Length, D01 Mounting Hole	PE4525	\$16.31	\$15.17	\$14.03	\$13.05	14
Male Right Angle, PCB Mount								
	Solder	.050" Dia. Contact, .155" Leg Length, D01 Mounting Hole	PE4526	\$26.65	\$24.78	\$22.92	\$21.32	15
Female Straight, PCB Mount								
	Solder	End Launch, .031" Board Thickness, .030" Round Contact	PE44206	\$14.34	\$13.34	\$12.33	\$11.47	16
		End Launch, .042" Board Thickness, .020" x .010" Tab Contact	PE44207	\$18.44	\$17.15	\$15.86	\$14.75	17
		End Launch, .042" Board Thickness, .030" Round Contact	PE44204	\$17.28	\$16.07	\$14.86	\$13.82	18
		End Launch, .047" Board Thickness, .020" x .010" Tab Contact	PE44208	\$19.20	\$17.86	\$16.51	\$15.36	19
		End Launch, .047" Board Thickness, .030" Round Contact	PE44205	\$19.76	\$18.38	\$16.99	\$15.81	20
		End Launch, .062" Board Thickness, .030" Round Contact	PE4542	\$13.88	\$12.91	\$11.94	\$11.10	21
		End Launch, .062" Board Thickness, .020" x .010" Tab Contact	PE4543	\$14.06	\$13.08	\$12.09	\$11.25	22
		Surface Mount, .050" Dia. Contact	PE4910	\$12.72	\$11.83	\$10.94	\$10.18	23
		Surface Mount, End Launch, .030" Dia. Contact	PE44235	\$15.30	\$14.23	\$13.16	\$12.24	24
		.050" Dia. Contact, .155" Leg Length, 27 GHz Precision, Max VSWR 1.20:1, D01 Mounting Hole	PE44342	\$41.34	\$38.45	\$35.55	\$33.07	25
Female Right Angle, PCB Mount								
	Solder	Surface Mount, .050" Dia. Contact	PE4911	\$19.40	\$18.04	\$16.68	\$15.52	26

SMA Connectors

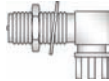
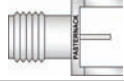
Product Image	Attachment Cable/Contact	Coax Type / Termination Type	Model No.	Price				Row
				1-24	25-49	50-99	100 +	
Female Straight, Bulkhead Mount, PCB Mount								
	Solder	End Launch, .042" Board Thickness, .030" Round Contact, F01 Mounting Hole	PE44211	\$18.75	\$17.44	\$16.13	\$15.00	1
		End Launch, .042" Board Thickness, .020" x .010" Tab Contact, F01 Mounting Hole	PE44213	\$19.91	\$18.52	\$17.12	\$15.93	2
		End Launch, .062" Board Thickness, .020" x .010" Tab Contact, F01 Mounting Hole	PE44214	\$18.75	\$17.44	\$16.13	\$15.00	3
		End Launch, .062" Board Thickness, .030" Round Contact, F01 Mounting Hole	PE44212	\$18.75	\$17.44	\$16.13	\$15.00	4
		.050" Dia. Contact, .155" Leg Length, .125" Max Panel, D01 & B02 Mounting Hole	PE4524	\$13.58	\$12.63	\$11.68	\$10.86	5
Female Right Angle, Bulkhead Mount, PCB Mount								
	Solder	.050" Dia. Contact, .155" Leg Length, .125" Max Panel, D01 & B02 Mounting Hole	PE4545	\$22.24	\$20.68	\$19.13	\$17.79	6
Reverse Polarity Male Straight, PCB Mount								
	Solder	.050" Dia. Contact, .155" Leg Length, D01 Mounting Hole	PE4873	\$18.59	\$17.29	\$15.99	\$14.87	7
Reverse Polarity Female Straight, PCB Mount								
	Solder	End Launch, .062" Board Thickness, .030" Round Contact	PE4874	\$19.25	\$17.90	\$16.56	\$15.40	8
		.050" Dia. Contact, .155" Leg Length, D01 Mounting Hole	PE4869	\$16.42	\$15.27	\$14.12	\$13.14	9
Reverse Polarity Female Right Angle, PCB Mount								
	Solder	.050" Dia. Contact, .155" Leg Length, D01 Mounting Hole	PE4870	\$24.88	\$23.14	\$21.40	\$19.90	10
Reverse Polarity Female Straight, Bulkhead Mount, PCB Mount								
	Solder	.050" Dia Contact, .155" Leg Length, .125" Max Panel, D01 & F01 Mounting Hole	PE4872	\$18.24	\$16.96	\$15.69	\$14.59	11
Reverse Polarity Female Right Angle, Bulkhead Mount, PCB Mount								
	Solder	.050" Dia. Contact, .155" Leg Length, .190" Max Panel, D01 & F01 Mounting Hole	PE4875	\$33.64	\$31.29	\$28.93	\$26.91	12
Reverse Thread Female Straight, PCB Mount								
	Solder	End Launch, .062" Board Thickness, .020" x .010" Tab Contact	PE44202	\$21.13	\$19.65	\$18.17	\$16.90	13
		End Launch, .062" Board Thickness, .030" Round Contact	PE44201	\$21.13	\$19.65	\$18.17	\$16.90	14

Connectors

See Our Website For Real-Time Stock Availability!

The GPS project was started in 1973 and was originally run with 24 satellites, known as the Navstar Constellation. It became fully operational in 1994.

SMA Connectors

Connectors

See Our Website For Real-Time Stock Availability!

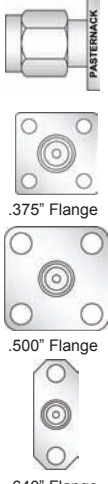
Product Image	Attachment Cable/Contact	Coax Type / Termination Type	Model No.	Price				Row
				1-24	25-49	50-99	100 +	
Male Straight, Panel Mount, Field Replaceable								
 <p>.375" Flange</p> <p>.500" Flange</p> <p>.640" Flange</p>	Mechanical	2 Hole Flange, .640" Flange Size, Accepts .012 Pin Size, Includes EMI/RFI Gasket	PE44028	\$31.11	\$28.93	\$26.75	\$24.89	1
		2 Hole Flange, .640" Flange Size, Accepts .015 Pin Size, Includes EMI/RFI Gasket	PE44029	\$31.11	\$28.93	\$26.75	\$24.89	2
		2 Hole Flange, .640" Flange Size, Accepts .018 Pin Size, Includes EMI/RFI Gasket	PE44030	\$31.11	\$28.93	\$26.75	\$24.89	3
		2 Hole Flange, .640" Flange Size, Accepts .020 Pin Size	PE44031	\$31.11	\$28.93	\$26.75	\$24.89	4
		2 Hole Flange, .640" Flange Size, Accepts .036 Pin Size	PE44032	\$31.11	\$28.93	\$26.75	\$24.89	5
		4 Hole Flange, .500" Flange Size, Accepts .012 Pin Size, Includes EMI/RFI Gasket	PE44018	\$31.11	\$28.93	\$26.75	\$24.89	6
		4 Hole Flange, .375" Flange Size, Accepts .012 Pin Size, Includes EMI/RFI Gasket	PE44005	\$31.11	\$28.93	\$26.75	\$24.89	7
		4 Hole Flange, .500" Flange Size, Accepts .015 Pin Size, Includes EMI/RFI Gasket	PE44019	\$31.11	\$28.93	\$26.75	\$24.89	8
		4 Hole Flange, .375" Flange Size, Accepts .015 Pin Size, Includes EMI/RFI Gasket	PE44006	\$31.11	\$28.93	\$26.75	\$24.89	9
		4 Hole Flange, .375" Flange Size, Accepts .018 Pin Size, Includes EMI/RFI Gasket	PE44007	\$31.11	\$28.93	\$26.75	\$24.89	10
		4 Hole Flange, .500" Flange Size, Accepts .018 Pin Size, Includes EMI/RFI Gasket	PE44020	\$31.11	\$28.93	\$26.75	\$24.89	11
		4 Hole Flange, .500" Flange Size, Accepts .020 Pin Size	PE44021	\$31.11	\$28.93	\$26.75	\$24.89	12
		4 Hole Flange, .375" Flange Size, Accepts .020 Pin Size	PE44008	\$31.11	\$28.93	\$26.75	\$24.89	13
		4 Hole Flange, .375" Flange Size, Accepts .036 Pin Size	PE44009	\$31.11	\$28.93	\$26.75	\$24.89	14
4 Hole Flange, .500" Flange Size, Accepts .036 Pin Size	PE44022	\$31.11	\$28.93	\$26.75	\$24.89	15		

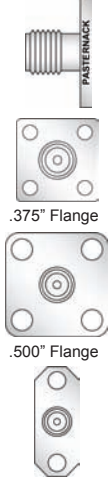
Female Straight, Panel Mount, Field Replaceable								
 <p>.375" Flange</p> <p>.500" Flange</p> <p>.640" Flange</p>	Mechanical	2 Hole Flange, .640" Flange Size, Accepts .012 Pin Size, Includes EMI/RFI Gasket	PE44023	\$30.35	\$28.23	\$26.10	\$24.28	16
		2 Hole Flange, .640" Flange Size, Accepts .015 Pin Size, Includes EMI/RFI Gasket	PE44024	\$24.88	\$23.14	\$21.40	\$19.90	17
		2 Hole Flange, .640" Flange Size, Accepts .018 Pin Size, Includes EMI/RFI Gasket	PE44025	\$27.00	\$25.11	\$23.22	\$21.60	18
		2 Hole Flange, .640" Flange Size, Accepts .020 Pin Size	PE44026	\$23.51	\$21.86	\$20.22	\$18.81	19
		2 Hole Flange, .640" Flange Size, Accepts .036 Pin Size	PE44027	\$24.88	\$23.14	\$21.40	\$19.90	20
		4 Hole Flange, .500" Flange Size, Accepts .012 Pin Size, Includes EMI/RFI Gasket	PE44010	\$24.88	\$23.14	\$21.40	\$19.90	21
		4 Hole Flange, .375" Flange Size, Accepts .012 Pin Size, Includes EMI/RFI Gasket	PE44000	\$26.04	\$24.22	\$22.39	\$20.83	22
		4 Hole Flange, .500" Flange Size, Accepts .015 Pin Size, Includes EMI/RFI Gasket	PE44011	\$24.88	\$23.14	\$21.40	\$19.90	23
		4 Hole Flange, .375" Flange Size, Accepts .015 Pin Size, Includes EMI/RFI Gasket	PE44001	\$26.04	\$24.22	\$22.39	\$20.83	24
		4 Hole Flange, .500" Flange Size, Accepts .018 Pin Size, Includes EMI/RFI Gasket	PE44012	\$24.88	\$23.14	\$21.40	\$19.90	25
		4 Hole Flange, .375" Flange Size, Accepts .018 Pin Size, Includes EMI/RFI Gasket	PE44002	\$26.04	\$24.22	\$22.39	\$20.83	26
		4 Hole Flange, .500" Flange Size, Accepts .020 Pin Size	PE44013	\$24.88	\$23.14	\$21.40	\$19.90	27
		4 Hole Flange, .375" Flange Size, Accepts .020 Pin Size	PE44003	\$24.57	\$22.85	\$21.13	\$19.66	28
		4 Hole Flange, .500" Flange Size, Accepts .036 Pin Size	PE44014	\$24.88	\$23.14	\$21.40	\$19.90	29
4 Hole Flange, .375" Flange Size, Accepts .036 Pin Size	PE44004	\$26.04	\$24.22	\$22.39	\$20.83	30		

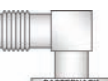
Female Right Angle, Panel Mount, Field Replaceable								
	Mechanical	4 Hole Flange, .500" Flange Size, Accepts .012 Pin Size, Includes EMI/RFI Gasket	PE44015	\$38.15	\$35.48	\$32.81	\$30.52	31
		4 Hole Flange, .500" Flange Size, Accepts .015 Pin Size, Includes EMI/RFI Gasket	PE44016	\$37.34	\$34.73	\$32.11	\$29.87	32
		4 Hole Flange, .500" Flange Size, Accepts .018 Pin Size, Includes EMI/RFI Gasket	PE44017	\$47.57	\$44.24	\$40.91	\$38.06	33



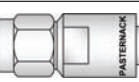

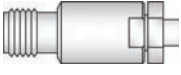
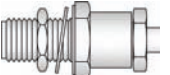

3.5mm Connectors

Product Image	Attachment Cable/Contact	Coax Type / Termination Type	Model No.	Price				Row
				1-24	25-49	50-99	100 +	
Male Straight, Cable Connectors								
	Clamp/Solder	PE-SR402AL, PE-SR402FL, RG402, .141" Semi-Rigid	PE4981	\$65.26	\$60.69	\$56.12	\$52.21	34
		PE-SR405AL, PE-SR405FL, RG405, .085" Semi-Rigid	PE4982	\$69.06	\$64.23	\$59.39	\$55.25	35

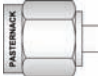
3.5mm Connectors

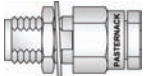
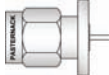
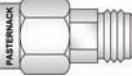
Product Image	Attachment Cable/Contact	Coax Type / Termination Type	Model No.	Price				Row
				1-24	25-49	50-99	100 +	
Female Straight, Cable Connectors								
	Clamp/Solder	PE-SR402AL, PE-SR402FL, RG402, .141" Semi-Rigid	PE4983	\$69.06	\$64.23	\$59.39	\$55.25	1
		PE-SR405AL, PE-SR405FL, RG405, .085" Semi-Rigid	PE4984	\$119.42	\$111.06	\$102.70	\$95.54	2
Female Straight, Bulkhead Mount, Cable Connectors								
	Clamp/Solder	PE-SR402AL, PE-SR402FL, RG402, B02 Mounting Hole, .141" Semi-Rigid	PE4985	\$216.64	\$201.48	\$186.31	\$173.31	3
		PE-SR405AL, PE-SR405FL, RG405, B02 Mounting Hole, .085" Semi-Rigid	PE4986	\$89.22	\$82.97	\$76.73	\$71.38	4

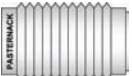
2.92mm Connectors

Product Image	Attachment Cable/Contact	Coax Type / Termination Type	Model No.	Price				Row
				1-24	25-49	50-99	100 +	
Male Straight, Cable Connectors								
	Solder	PE-SR402AL, PE-SR402FL, RG402, .141" Semi-Rigid	PE4987	\$35.26	\$32.79	\$30.32	\$28.21	5
		PE-SR405AL, PE-SR405FL, RG405, .085" Semi-Rigid	PE4988	\$36.51	\$33.95	\$31.40	\$29.21	6
		.118" Dia. Semi-Rigid	PE4989	\$49.91	\$46.42	\$42.92	\$39.93	7
Female Straight, Cable Connectors								
	Clamp/Solder	PE-SR402AL, PE-SR402FL, RG402, .141" Semi-Rigid	PE44227	\$87.30	\$81.19	\$75.08	\$69.84	8
		PE-SR405AL, PE-SR405FL, RG405, .085" Semi-Rigid	PE44228	\$87.30	\$81.19	\$75.08	\$69.84	9
Female Straight, Bulkhead Mount, Cable Connectors								
	Clamp/Solder	PE-SR402AL, PE-SR402FL, RG402, B02 Mounting Hole, .141" Semi-Rigid	PE4990	\$99.76	\$92.78	\$85.79	\$79.81	10
		PE-SR405AL, PE-SR405FL, RG405, B02 Mounting Hole, .085" Semi-Rigid	PE4992	\$112.22	\$104.36	\$96.51	\$89.78	11
Male Straight, Panel Mount, Terminal								
	Solder	2 Hole Flange, .025" Dia. Stub Contact, C06 Mounting Hole	PE44347	\$105.94	\$98.52	\$91.11	\$84.75	12
Male Straight, Threaded Mount, Field Replaceable								
	Mechanical	Accepts .012" Dia. Pin	PE44234	\$74.83	\$69.59	\$64.35	\$59.86	13
Male Straight, Panel Mount, Field Replaceable								
	Mechanical	2 Hole Flange, Accepts .012" Dia. Pin, C02 Mounting Hole	PE44232	\$53.60	\$49.85	\$46.10	\$42.88	14
		4 Hole Flange, Accepts .012" Dia. Pin, A01 Mounting Hole	PE44233	\$74.83	\$69.59	\$64.35	\$59.86	15
Female Straight, Threaded Mount, Field Replaceable								
	Mechanical	Accepts .012" Pin	PE44231	\$74.83	\$69.59	\$64.35	\$59.86	16
Female Straight, Panel Mount, Field Replaceable								
	Mechanical	2 Hole Flange, Accepts .012" Dia. Pin, C01 Mounting Hole	PE44229	\$93.48	\$86.94	\$80.39	\$74.78	17
		4 Hole Flange, Accepts .012" Dia. Pin, A01 Mounting Hole	PE44230	\$90.39	\$84.06	\$77.74	\$72.31	18









Connectors

See Our Website For Real-Time Stock Availability!

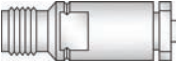

2.4mm Connectors

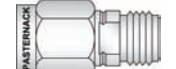
Connectors

See Our Website For Real-Time Stock Availability!

Product Image	Attachment Cable/Contact	Coax Type / Termination Type	Model No.	Price				Row
				1-24	25-49	50-99	100 +	
Male Straight, Cable Connectors								
	Clamp/Solder	PE-SR405AL, PE-SR405FL, RG405, .085" Semi-Rigid	PE44345	\$105.94	\$98.52	\$91.11	\$84.75	1
	Solder	PE-SR405AL, PE-SR405FL, RG405, .085" Semi-Rigid	PE44215	\$45.65	\$42.45	\$39.26	\$36.52	2
Female Straight, Cable Connectors								
	Clamp/Solder	PE-SR405AL, PE-SR405FL, RG405, .085" Semi-Rigid	PE44216	\$133.15	\$123.83	\$114.51	\$106.52	3
Female Straight, Bulkhead Mount, Cable Connectors								
	Clamp/Solder	PE-SR405AL, PE-SR405FL, RG405, B14 Mounting Hole, .085" Semi-Rigid	PE44346	\$112.22	\$104.36	\$96.51	\$89.78	4
Male Straight, Panel Mount, Terminal								
	Solder	2 Hole Flange, Tab, .003" X .011" Tab Contact, C05 Mounting Hole	PE44223	\$118.40	\$110.11	\$101.82	\$94.72	5
		2 Hole Flange, .024" Dia. Stub Contact, .250" Extended Dielectric, C05 Mounting Hole	PE44220	\$112.22	\$104.36	\$96.51	\$89.78	6
		4 Hole Flange, Tab, .003" X .011" Tab Contact, A01 Mounting Hole	PE44224	\$187.11	\$174.01	\$160.91	\$149.69	7
		4 Hole Flange, .024" Dia. Stub Contact, .250" Extended Dielectric, A01 Mounting Hole	PE44221	\$97.23	\$90.42	\$83.62	\$77.78	8
Female Straight, Panel Mount, Terminal								
	Solder	2 Hole Flange, Tab, .003" X .011" Tab Contact, C05 Mounting Hole	PE44225	\$124.69	\$115.96	\$107.23	\$99.75	9
		2 Hole Flange, .024" Dia Stub Contact, .250" Extended Dielectric, C05 Mounting Hole	PE44217	\$121.70	\$113.18	\$104.66	\$97.36	10
		4 Hole Flange, Tab, .003" X .011" Tab Contact, A01 Mounting Hole	PE44226	\$97.23	\$90.42	\$83.62	\$77.78	11
		4 Hole Flange, .024" Dia Stub Contact, .250" Extended Dielectric, A01 Mounting Hole	PE44218	\$102.80	\$95.60	\$88.41	\$82.24	12
Male Straight, Threaded Mount, Field Replaceable								
	Mechanical	Accepts .012" Dia. Pin	PE44222	\$97.23	\$90.42	\$83.62	\$77.78	13
Female Straight, Threaded Mount, Field Replaceable								
	Mechanical	Accepts .012" Dia. Pin	PE44219	\$97.23	\$90.42	\$83.62	\$77.78	14



1.85mm Connectors

Product Image	Attachment Cable/Contact	Coax Type / Termination Type	Model No.	Price				Row
				1-24	25-49	50-99	100 +	
Male Straight, Cable Connectors								
	Clamp/Solder	PE-047SR, PE-SR047AL, PE-SR047FL, .047" Semi-Rigid	PE44335	\$124.69	\$115.96	\$107.23	\$99.75	15
		PE-SR405AL, PE-SR405FL, RG405, .085" Semi-Rigid	PE44336	\$112.22	\$104.36	\$96.51	\$89.78	16
Male Straight, Threaded Mount, Field Replaceable								
	Mechanical	Accepts .009" Dia. Pin	PE44338	\$112.22	\$104.36	\$96.51	\$89.78	17
Female Straight, Threaded Mount, Field Replaceable								
	Mechanical	Accepts .009" Dia. Pin	PE44339	\$112.22	\$104.36	\$96.51	\$89.78	18

1.85mm Connectors

Product Image	Attachment Cable/Contact	Coax Type / Termination Type	Model No.	Price				Row
				1-24	25-49	50-99	100 +	
Female Straight, Panel Mount, Field Replaceable								
	Mechanical	2 Hole Flange, Accepts .009" Dia. Pin, C01 Mounting Hole	PE44337	\$124.69	\$115.96	\$107.23	\$99.75	1

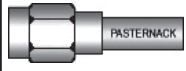
SSMA Connectors

Product Image	Attachment Cable/Contact	Coax Type / Termination Type	Model No.	Price				Row
				1-24	25-49	50-99	100 +	
Male Straight, Cable Connectors								
	Crimp/Solder	RG188-DS, RG316-DS	PE44416	\$17.95	\$16.69	\$15.44	\$14.36	2
		RG174, RG316, RG188	PE44379	\$18.20	\$16.93	\$15.65	\$14.56	3
		RG178, RG196	PE44381	\$19.96	\$18.56	\$17.17	\$15.97	4
	Solder/Solder	RG188-DS, RG316-DS	PE44417	\$18.80	\$17.48	\$16.17	\$15.04	5
		PE-034SR, .034" Semi-Rigid	PE44440	\$22.34	\$20.78	\$19.21	\$17.87	6
		PE-047SR, PE-SR047AL, PE-SR047FL, .047" Semi-Rigid	PE44441	\$22.34	\$20.78	\$19.21	\$17.87	7
		PE-SR405AL, PE-SR405FL, RG405, .085" Semi-Rigid	PE44383	\$24.88	\$23.14	\$21.40	\$19.90	8
		RG174, RG316, RG188	PE4184	\$19.30	\$17.95	\$16.60	\$15.44	9
		RG178, RG196	PE4199	\$22.30	\$20.74	\$19.18	\$17.84	10
	Solder (Without Contact)	PE-SR405AL, PE-SR405FL, RG405, .085" Semi-Rigid	PE44382	\$21.13	\$19.65	\$18.17	\$16.90	11

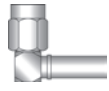
Male Right Angle, Cable Connectors								
	Crimp/Solder	RG188-DS, RG316-DS	PE44418	\$22.80	\$21.20	\$19.61	\$18.24	12
		RG174, RG316, RG188	PE44378	\$21.13	\$19.65	\$18.17	\$16.90	13
		RG178, RG196	PE44380	\$41.75	\$38.83	\$35.91	\$33.40	14
	Solder/Solder	RG188-DS, RG316-DS	PE44419	\$22.30	\$20.74	\$19.18	\$17.84	15
		PE-034SR, .034" Semi-Rigid	PE44420	\$34.86	\$32.42	\$29.98	\$27.89	16
		PE-047SR, PE-SR047AL, PE-SR047FL, .047" Semi-Rigid	PE44421	\$34.86	\$32.42	\$29.98	\$27.89	17
		PE-SR405AL, PE-SR405FL, RG405, .085" Semi-Rigid	PE44384	\$24.88	\$23.14	\$21.40	\$19.90	18
		RG174, RG316, RG188	PE44401	\$26.75	\$24.88	\$23.01	\$21.40	19
		RG178, RG196	PE44402	\$22.30	\$20.74	\$19.18	\$17.84	20

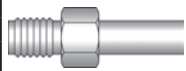
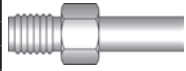
Female Straight, Cable Connectors								
	Crimp/Solder	RG188-DS, RG316-DS	PE44422	\$21.20	\$19.72	\$18.23	\$16.96	21
		RG174, RG316, RG188	PE44385	\$21.68	\$20.16	\$18.64	\$17.34	22
		RG178, RG196	PE44386	\$37.19	\$34.59	\$31.98	\$29.75	23
	Solder/Solder	RG188-DS, RG316-DS	PE44423	\$22.30	\$20.74	\$19.18	\$17.84	24
		PE-034SR, .034" Semi-Rigid	PE44424	\$27.31	\$25.40	\$23.49	\$21.85	25
		PE-047SR, PE-SR047AL, PE-SR047FL, .047" Semi-Rigid	PE44425	\$26.04	\$24.22	\$22.39	\$20.83	26
		PE-SR405AL, PE-SR405FL, RG405, .085" Semi-Rigid	PE44387	\$20.77	\$19.32	\$17.86	\$16.62	27
		RG174, RG316, RG188	PE44403	\$20.05	\$18.65	\$17.24	\$16.04	28
		RG178, RG196	PE44404	\$20.05	\$18.65	\$17.24	\$16.04	29

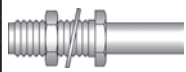
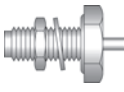
Female Straight, Bulkhead Mount, Cable Connectors								
	Crimp/Solder	RG188-DS, RG316-DS	PE44426	\$22.30	\$20.74	\$19.18	\$17.84	30
		RG174, RG316, RG188	PE44388	\$29.74	\$27.66	\$25.58	\$23.79	31
		RG178, RG196	PE44389	\$25.60	\$23.81	\$22.02	\$20.48	32
	Solder/Solder	RG188-DS, RG316-DS	PE44427	\$21.20	\$19.72	\$18.23	\$16.96	33
		PE-034SR, .034" Semi-Rigid	PE44428	\$33.79	\$31.42	\$29.06	\$27.03	34
		PE-047SR, PE-SR047AL, PE-SR047FL, .047" Semi-Rigid	PE44429	\$33.79	\$31.42	\$29.06	\$27.03	35
		PE-SR405AL, PE-SR405FL, RG405, .085" Semi-Rigid	PE44390	\$23.66	\$22.00	\$20.35	\$18.93	36
		RG174, RG316, RG188	PE44405	\$21.20	\$19.72	\$18.23	\$16.96	37
		RG178, RG196	PE44406	\$21.20	\$19.72	\$18.23	\$16.96	38

Connectors

See Our Website For Real-Time Stock Availability!

SSMA Connectors

Connectors





See Our Website For Real-Time Stock Availability!

Product Image	Attachment Cable/Contact	Coax Type / Termination Type	Model No.	Price				Row
				1-24	25-49	50-99	100 +	
Female Straight, Panel Mount, Cable Connectors								
	Solder/Solder	2 Hole Flange, PE-047SR, PE-SR047AL, PE-SR047FL, C07 Mounting Hole, .047" Semi-Rigid	PE44436	\$27.31	\$25.40	\$23.49	\$21.85	1
		2 Hole Flange, PE-SR405AL, PE-SR405FL, RG405, C07 Mounting Hole, .085" Semi-Rigid	PE44437	\$29.94	\$27.84	\$25.75	\$23.95	2
		4 Hole Flange, PE-047SR, PE-SR047AL, PE-SR047FL, A22 Mounting Hole, .047" Semi-Rigid	PE44438	\$35.77	\$33.27	\$30.76	\$28.62	3
		4 Hole Flange, PE-SR405AL, PE-SR405FL, RG405, A22 Mounting Hole, .085" Semi-Rigid	PE44439	\$31.11	\$28.93	\$26.75	\$24.89	4
Male Straight, Panel Mount, Terminal								
	Solder	2 Hole Flange, Solder Cup Contact, C07 Mounting Hole	PE44431	\$24.88	\$23.14	\$21.40	\$19.90	5
		4 Hole Flange, Solder Cup Contact, A22 Mounting Hole	PE44432	\$24.88	\$23.14	\$21.40	\$19.90	6
Female Straight, Bulkhead Mount, Terminal								
	Solder	Solder Cup Contact, Rear Mount, .130" Max Panel, B01 Mounting Hole	PE44393	\$23.13	\$21.51	\$19.89	\$18.50	7
		Turret, .050" Dia. Contact, Front Mount, .093" Max Panel, B01 Mounting Hole	PE44392	\$24.88	\$23.14	\$21.40	\$19.90	8
Female Straight, Panel Mount, Terminal								
	Solder	2 Hole Flange, .034" Dia. Stub Contact, .375" Extended Dielectric, C07 Mounting Hole	PE44433	\$34.40	\$31.99	\$29.58	\$27.52	9
		2 Hole Flange, Solder Cup Contact, C07 Mounting Hole	PE44395	\$24.88	\$23.14	\$21.40	\$19.90	10
		4 Hole Flange, .034" Dia. Stub Contact, .375" Extended Dielectric, A22 Mounting Hole	PE44434	\$30.40	\$28.27	\$26.14	\$24.32	11
		4 Hole Flange, Solder Cup Contact, A22 Mounting Hole	PE44394	\$27.36	\$25.44	\$23.53	\$21.89	12
Male Straight, PCB Mount								
	Solder	.034" Dia Contact, .155" Leg Length, Thru Hole, D02 Mounting Hole	PE44430	\$19.40	\$18.04	\$16.68	\$15.52	13
Female Straight, PCB Mount								
	Solder	.034" Dia. Contact, .155" Leg Length, Thru Hole, D02 Mounting Hole	PE44391	\$23.56	\$21.91	\$20.26	\$18.85	14
Female Right Angle, PCB Mount								
	Solder	.034" Dia. Contact, .155" Leg Length, Thru Hole, D02 Mounting Hole	PE44435	\$34.00	\$31.62	\$29.24	\$27.20	15

N Connectors

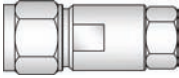
Product Image	Attachment Cable/Contact	Coax Type / Termination Type	Model No.	Price				Row
				1-24	25-49	50-99	100 +	
Male Straight, Cable Connectors								
	Crimp/Solder	RG8X, PE-C240	PE4344	\$16.57	\$15.41	\$14.25	\$13.26	16
		PE-B400, PE-B405, PE-C400	PE4550	\$11.50	\$10.70	\$9.89	\$9.20	17
		PE-C195	PE44520	\$11.25	\$10.46	\$9.68	\$9.00	18
		PE-C200	PE44044	\$11.75	\$10.93	\$10.11	\$9.40	19
		PE-C240, Hex Nut	PE44521	\$11.25	\$10.46	\$9.68	\$9.00	20
		PE-C400, Hex Nut	PE44522	\$12.16	\$11.31	\$10.46	\$9.73	21
		PE-C600	PE44454	\$41.70	\$38.78	\$35.86	\$33.36	22
		PE-C600	PE44523	\$22.50	\$20.93	\$19.35	\$18.00	23
		RG174, RG316, RG188	PE4429	\$12.77	\$11.88	\$10.98	\$10.22	24
		RG178, RG196	PE4647	\$21.13	\$19.65	\$18.17	\$16.90	25
		RG213, RG8	PE4430	\$12.50	\$11.63	\$10.75	\$10.00	26
		RG214, RG9, RG225, RG393	PE4048	\$12.69	\$11.80	\$10.91	\$10.15	27
		RG58	PE4329	\$10.80	\$10.04	\$9.29	\$8.64	28
		RG59, RG62	PE4432	\$10.99	\$10.22	\$9.45	\$8.79	29
		RG55, RG141, RG142, RG223, RG400	PE4042	\$11.96	\$11.12	\$10.29	\$9.57	30

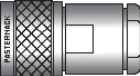

N Connectors

Product Image	Attachment Cable/Contact	Coax Type / Termination Type	Model No.	Price				Row
				1-24	25-49	50-99	100 +	
	Clamp	1/4 inch Super Flexible, Precision, Low PIM	PE44726	\$36.21	\$33.68	\$31.14	\$28.97	1
		1/2 inch Flexible, Precision, Low PIM	PE44735	\$27.83	\$25.88	\$23.93	\$22.26	2
		1/2 inch Super Flexible, Precision, Low PIM	PE44729	\$27.83	\$25.88	\$23.93	\$22.26	3
	Clamp/Solder	RG8X, PE-C240	PE4431	\$10.60	\$9.86	\$9.12	\$8.48	4
		PE-B400, PE-B405, PE-C400	PE4133	\$14.08	\$13.09	\$12.11	\$11.26	5
		PE-C200	PE44043	\$10.60	\$9.86	\$9.12	\$8.48	6
		PE-C300	PE44045	\$15.95	\$14.83	\$13.72	\$12.76	7
		PE-C500	PE44046	\$24.72	\$22.99	\$21.26	\$19.78	8
		PE-C600	PE44349	\$46.87	\$43.59	\$40.31	\$37.50	9
		PE-SR401AL, PE-SR401FL, RG401, .250" Semi-Rigid	PE4434	\$15.35	\$14.28	\$13.20	\$12.28	10
		PE-SR402AL, PE-SR402FL, RG402, .141" Semi-Rigid	PE4006	\$15.35	\$14.28	\$13.20	\$12.28	11
		PE-SR405AL, PE-SR405FL, RG405, .085" Semi-Rigid	PE4129	\$15.35	\$14.28	\$13.20	\$12.28	12
		1/2" Helical, Low PIM	PE44552	\$47.73	\$44.39	\$41.05	\$38.18	13
		1/2" Annular, Low PIM	PE44562	\$47.73	\$44.39	\$41.05	\$38.18	14
		7/8" Annular, Low PIM	PE44563	\$59.63	\$55.46	\$51.28	\$47.70	15
		7/8" Helical, Low PIM	PE44553	\$59.63	\$55.46	\$51.28	\$47.70	16
		RG14, RG217	PE4221	\$23.36	\$21.72	\$20.09	\$18.69	17
		RG174, RG316, RG188	PE4224	\$12.95	\$12.04	\$11.14	\$10.36	18
		RG213, RG214, RG8, RG9, RG225, RG393, RG11	PE4062	\$11.07	\$10.30	\$9.52	\$8.86	19
		RG218	PE4433	\$70.68	\$65.73	\$60.78	\$56.54	20
		RG58, RG55, RG141, RG142, RG400, RG223	PE4081	\$8.61	\$8.01	\$7.40	\$6.89	21
		RG59, RG62	PE4331	\$12.92	\$12.02	\$11.11	\$10.34	22
			Clamp/Solder (Captive Contact)	RG213, RG214, RG8, RG9, RG225, RG393, RG11	PE4132	\$12.59	\$11.71	\$10.83
	Solder/Solder	PE-047SR, PE-SR047AL, PE-SR047FL, .047" Semi-Rigid	PE4934	\$24.72	\$22.99	\$21.26	\$19.78	24
		PE-SR401AL, PE-SR401FL, RG401, Precision, .250" Semi-Rigid	PE4376	\$31.92	\$29.69	\$27.45	\$25.54	25
		PE-SR402AL, PE-SR402FL, RG402, Precision, .141" Semi-Rigid	PE4140	\$18.39	\$17.10	\$15.82	\$14.71	26
		PE-SR405AL, PE-SR405FL, RG405, Precision, .085" Semi-Rigid	PE4222	\$28.22	\$26.24	\$24.27	\$22.58	27

Male Right Angle, Cable Connectors

	Crimp/Solder	PE-B400, PE-B405, PE-C400	PE4939	\$32.45	\$30.18	\$27.91	\$25.96	28
		PE-C100, RG174, RG316	PE44675	\$20.42	\$18.99	\$17.56	\$16.34	29
		PE-C195	PE44524	\$21.38	\$19.88	\$18.39	\$17.10	30
		PE-C240	PE44525	\$23.81	\$22.14	\$20.48	\$19.05	31
		PE-C400, Hex Nut	PE44526	\$28.12	\$26.15	\$24.18	\$22.50	32
		PE-C600	PE44527	\$41.60	\$38.69	\$35.78	\$33.28	33
		RG213, RG8	PE4482	\$27.65	\$25.71	\$23.78	\$22.12	34
		RG214, RG9, RG225, RG393	PE4483	\$31.42	\$29.22	\$27.02	\$25.14	35
		RG58	PE4485	\$20.45	\$19.02	\$17.59	\$16.36	36
		RG55, RG141, RG142, RG223, RG400	PE4484	\$22.61	\$21.03	\$19.44	\$18.09	37
	Clamp/Solder	PE-B400, PE-B405, PE-C400	PE4938	\$21.20	\$19.72	\$18.23	\$16.96	38
		PE-SR401AL, PE-SR401FL, RG401, .250" Semi-Rigid	PE4935	\$22.75	\$21.16	\$19.57	\$18.20	39
		1/2" Helical, Low PIM	PE44554	\$54.87	\$51.03	\$47.19	\$43.90	40
		1/2" Annular, Low PIM	PE44564	\$58.47	\$54.38	\$50.28	\$46.78	41
		RG213, RG214, RG8, RG9, RG393, RG225	PE4136	\$18.39	\$17.10	\$15.82	\$14.71	42
		RG58, RG55, RG141, RG142, RG400, RG223	PE4135	\$15.96	\$14.84	\$13.73	\$12.77	43
	Solder/Solder	PE-SR402AL, PE-SR402FL, RG402, .141" Semi-Rigid	PE4936	\$18.19	\$16.92	\$15.64	\$14.55	44
		PE-SR405AL, PE-SR405FL, RG405, .085" Semi-Rigid	PE4937	\$19.91	\$18.52	\$17.12	\$15.93	45

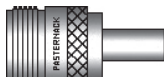
Female Straight, Cable Connectors

	Crimp/Solder	PE-C195	PE44532	\$14.24	\$13.24	\$12.25	\$11.39	46
		PE-C240	PE44533	\$14.24	\$13.24	\$12.25	\$11.39	47
		PE-C400	PE44534	\$17.88	\$16.63	\$15.38	\$14.30	48
		PE-C600	PE44535	\$35.77	\$33.27	\$30.76	\$28.62	49
		RG174, RG316, RG188	PE4438	\$15.96	\$14.84	\$13.73	\$12.77	50
		RG213, RG8	PE4435	\$11.90	\$11.07	\$10.23	\$9.52	51
		RG214, RG9, RG225, RG393	PE4191	\$13.07	\$12.16	\$11.24	\$10.46	52
		RG58	PE4436	\$11.90	\$11.07	\$10.23	\$9.52	53
RG55, RG141, RG142, RG223, RG400	PE4134	\$12.31	\$11.45	\$10.59	\$9.85	54		
	Clamp	1/4 inch Super Flexible, Precision, Low PIM	PE44727	\$36.21	\$33.68	\$31.14	\$28.97	55
		1/2 inch Flexible, Precision, Low PIM	PE44737	\$27.83	\$25.88	\$23.93	\$22.26	56
		1/2 inch Super Flexible, Precision, Low PIM	PE44731	\$27.83	\$25.88	\$23.93	\$22.26	57

Connectors



See Our Website For Real-Time Stock Availability!





N Connectors

Connectors

See Our Website For Real-Time Stock Availability!

Product Image	Attachment Cable/Contact	Coax Type / Termination Type	Model No.	Price				Row
				1-24	25-49	50-99	100 +	
	Clamp/Solder	PE-B400, PE-B405, PE-C400	PE4372	\$21.28	\$19.79	\$18.30	\$17.02	1
		PE-C600	PE44350	\$56.04	\$52.12	\$48.19	\$44.83	2
		PE-SR401AL, PE-SR401FL, RG401, .250" Semi-Rigid	PE4439	\$17.95	\$16.69	\$15.44	\$14.36	3
		PE-SR402AL, PE-SR402FL, RG402, .141" Semi-Rigid	PE4138	\$15.35	\$14.28	\$13.20	\$12.28	4
		PE-SR405AL, PE-SR405FL, RG405, .085" Semi-Rigid	PE4130	\$15.60	\$14.51	\$13.42	\$12.48	5
		1/2" Helical, Low PIM	PE44555	\$47.73	\$44.39	\$41.05	\$38.18	6
		1/2" Annular, Low PIM	PE44565	\$59.63	\$55.46	\$51.28	\$47.70	7
		7/8" Annular, Low PIM	PE44566	\$59.63	\$55.46	\$51.28	\$47.70	8
		7/8" Helical, Low PIM	PE44556	\$59.63	\$55.46	\$51.28	\$47.70	9
		RG14, RG217	PE4645	\$45.60	\$42.41	\$39.22	\$36.48	10
		RG174, RG316, RG188	PE4437	\$14.75	\$13.72	\$12.69	\$11.80	11
		RG213, RG214, RG8, RG9, RG225, RG393, RG11	PE4061	\$12.92	\$12.02	\$11.11	\$10.34	12
		RG218	PE4646	\$46.05	\$42.83	\$39.60	\$36.84	13
		RG58, RG55, RG141, RG142, RG400, RG223	PE4072	\$12.31	\$11.45	\$10.59	\$9.85	14
RG59, RG62	PE4330	\$12.46	\$11.59	\$10.72	\$9.97	15		
	Clamp/Solder (Captive Contact)	RG213, RG214, RG8, RG9, RG225, RG393, RG11	PE4059	\$20.16	\$18.75	\$17.34	\$16.13	16
	Solder/Solder	PE-047SR, PE-SR047AL, PE-SR047FL, Precision, .047" Semi-Rigid	PE4945	\$49.91	\$46.42	\$42.92	\$39.93	17
		PE-SR402AL, PE-SR402FL, RG402, Precision, .141" Semi-Rigid	PE4652	\$24.34	\$22.64	\$20.93	\$19.47	18
		PE-SR405AL, PE-SR405FL, RG405, Precision, .085" Semi-Rigid	PE4653	\$22.34	\$20.78	\$19.21	\$17.87	19

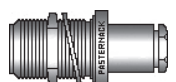





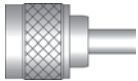
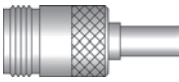

Female Straight, Bulkhead Mount, Cable Connectors

	Crimp/Solder	PE-B400, PE-B405, PE-C400, G01 Mounting Hole	PE4944	\$22.75	\$21.16	\$19.57	\$18.20	20
		PE-C195, G01 Mounting Hole	PE44528	\$13.07	\$12.16	\$11.24	\$10.46	21
		PE-C240, G01 Mounting Hole	PE44529	\$12.31	\$11.45	\$10.59	\$9.85	22
		PE-C400, White Bronze, G01 Mounting Hole	PE44530	\$16.87	\$15.69	\$14.51	\$13.50	23
		PE-C600, G01 Mounting Hole	PE44531	\$29.79	\$27.70	\$25.62	\$23.83	24
		RG174, RG316, RG188, G01 Mounting Hole	PE4442	\$20.82	\$19.36	\$17.91	\$16.66	25
		RG213, RG8, G01 Mounting Hole	PE4940	\$22.75	\$21.16	\$19.57	\$18.20	26
		RG214, RG9, RG225, RG393, G01 Mounting Hole	PE4941	\$22.95	\$21.34	\$19.74	\$18.36	27
		RG58, G01 Mounting Hole	PE4440	\$13.15	\$12.23	\$11.31	\$10.52	28
		RG55, RG141, RG142, RG223, RG400, G01 Mounting Hole	PE4371	\$14.90	\$13.86	\$12.81	\$11.92	29
	Clamp/Solder	PE-B400, PE-B405, PE-C400, G01 Mounting Hole	PE4943	\$18.60	\$17.30	\$16.00	\$14.88	30
		PE-SR401AL, PE-SR401FL, RG401, G01 Mounting Hole, .250" Semi-Rigid	PE4942	\$19.10	\$17.76	\$16.43	\$15.28	31
		PE-SR402AL, PE-SR402FL, RG402, G01 Mounting Hole, .141" Semi-Rigid	PE4113	\$15.60	\$14.51	\$13.42	\$12.48	32
		PE-SR405AL, PE-SR405FL, RG405, G01 Mounting Hole, .085" Semi-Rigid	PE4443	\$15.35	\$14.28	\$13.20	\$12.28	33
		RG174, RG316, RG188, G01 Mounting Hole	PE4441	\$16.65	\$15.48	\$14.32	\$13.32	34
		RG178, G01 Mounting Hole	PE44633	\$16.65	\$15.48	\$14.32	\$13.32	35
		RG213, RG214, RG8, RG9, RG225, RG393, RG11, G01 Mounting Hole	PE4223	\$18.39	\$17.10	\$15.82	\$14.71	36
		RG58, RG55, RG141, RG142, RG400, RG223, G01 Mounting Hole	PE4114	\$14.90	\$13.86	\$12.81	\$11.92	37
		RG59, RG62, G01 Mounting Hole	PE4297	\$23.66	\$22.00	\$20.35	\$18.93	38
		PE-047SR, PE-SR047AL, PE-SR047FL, Precision, G01 Mounting Hole, .047" Semi-Rigid	PE4946	\$43.52	\$40.47	\$37.43	\$34.82	39
	Solder/Solder	PE-SR402AL, PE-SR402FL, RG402, Precision, G01 Mounting Hole, .141" Semi-Rigid	PE4654	\$25.44	\$23.66	\$21.88	\$20.35	40
		PE-SR405AL, PE-SR405FL, RG405 Precision, G01 Mounting Hole, .085" Semi-Rigid	PE4655	\$26.75	\$24.88	\$23.01	\$21.40	41

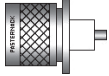
Female Straight, Panel Mount, Cable Connectors

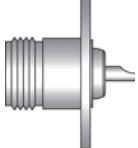
	Crimp/Solder	4 Hole Flange, RG213, RG8, A05 Mounting Hole	PE44065	\$16.75	\$15.58	\$14.41	\$13.40	42
		4 Hole Flange, RG214, RG9, RG225, RG393, A05 Mounting Hole	PE44066	\$18.24	\$16.96	\$15.69	\$14.59	43
		4 Hole Flange, RG58, A05 Mounting Hole	PE44069	\$17.73	\$16.49	\$15.25	\$14.18	44
		4 Hole Flange, RG55, RG141, RG142, RG223, RG400, A05 Mounting Hole	PE44068	\$17.07	\$15.88	\$14.68	\$13.66	45
	Clamp/Solder	4 Hole Flange, PE-SR401AL, PE-SR401FL, RG401, A05 Mounting Hole, .250" Semi-Rigid	PE44071	\$19.10	\$17.76	\$16.43	\$15.28	46
		4 Hole Flange, PE-SR402AL, PE-SR402FL, RG402, A05 Mounting Hole, .141" Semi-Rigid	PE44072	\$19.10	\$17.76	\$16.43	\$15.28	47
		4 Hole Flange, PE-SR405AL, PE-SR405FL, RG405, A05 Mounting Hole, .085" Semi-Rigid	PE44073	\$18.80	\$17.48	\$16.17	\$15.04	48
		4 Hole Flange, RG174, RG316, RG188, A05 Mounting Hole	PE44070	\$14.35	\$13.35	\$12.34	\$11.48	49
		4 Hole Flange, RG58, RG55, RG141, RG142, RG400, RG223, A05 Mounting Hole	PE4141	\$12.21	\$11.36	\$10.50	\$9.77	50
	Clamp/Solder (Captive Contact)	4 Hole Flange, RG213, RG214, RG8, RG9, RG225, RG393, RG11, A05 Mounting Hole	PE4060	\$19.09	\$17.75	\$16.42	\$15.27	51

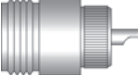
N Connectors

Product Image	Attachment Cable/Contact	Coax Type / Termination Type	Model No.	Price				Row
				1-24	25-49	50-99	100 +	
Reverse Polarity Male Straight, Cable Connectors								
	Crimp/Solder	PE-B400, PE-B405, PE-C400	PE44470	\$23.66	\$22.00	\$20.35	\$18.93	1
		RG213, RG8	PE44472	\$23.66	\$22.00	\$20.35	\$18.93	2
		RG214, RG393, RG9, RG225	PE44474	\$21.60	\$20.09	\$18.58	\$17.28	3
		RG58	PE44473	\$20.50	\$19.07	\$17.63	\$16.40	4
		RG55, RG141, RG142, RG223, RG400	PE44471	\$25.74	\$23.94	\$22.14	\$20.59	5
Reverse Polarity Female Straight, Cable Connectors								
	Crimp/Solder	RG213, RG8	PE44478	\$20.50	\$19.07	\$17.63	\$16.40	6
		RG214, RG9, RG225, RG393	PE44477	\$22.34	\$20.78	\$19.21	\$17.87	7
		RG58	PE44476	\$20.50	\$19.07	\$17.63	\$16.40	8
		RG55, RG141, RG142, RG223, RG400	PE44475	\$22.34	\$20.78	\$19.21	\$17.87	9
Male Straight, Bulkhead Mount, Terminal								
	Solder	Solder Cup Contact, Front Mount, G01 Mounting Hole	PE4489	\$26.14	\$24.31	\$22.48	\$20.91	10
		Solder Cup Contact, Front Mount, B04 Mounting Hole	PE4490	\$25.03	\$23.28	\$21.53	\$20.02	11
Male Straight, Panel Mount, Terminal								
	Solder	4 Hole Flange, .050" Dia. Contact, .590" Extended Dielectric, A05 Mounting Hole	PE44653	\$54.82	\$50.98	\$47.15	\$43.86	12
		4 Hole Flange, .120" Dia Stub Contact, .330 Extended Dielectric, A05 Mounting Hole	PE4491	\$23.00	\$21.39	\$19.78	\$18.40	13
		4 Hole Flange, Solder Cup Contact, A05 Mounting Hole	PE4131	\$11.38	\$10.58	\$9.79	\$9.10	14
Female Straight, Bulkhead Mount, Terminal								
	Solder	.120" Half Moon Contact, Rear Mount, .325" Max Panel, G01 Mounting Hole	PE4139	\$8.56	\$7.96	\$7.36	\$6.85	15
		Solder Cup Contact, Front Mount, F05 Mounting Hole	PE4488	\$10.99	\$10.22	\$9.45	\$8.79	16
		Solder Cup Contact, Front Mount, Hermetically Sealed, G01 Mounting Hole	PE4137	\$12.72	\$11.83	\$10.94	\$10.18	17
Female Straight, Panel Mount, Terminal								
	Solder	2 Hole Flange, .005" X .120" Tab Contact, C04 Mounting Hole	PE44078	\$20.77	\$19.32	\$17.86	\$16.62	18
		2 Hole Flange, .050" Dia. Stub Contact, .590" Extended Dielectric, C04 Mounting Hole	PE44079	\$33.74	\$31.38	\$29.02	\$26.99	19
		2 Hole Flange, Solder Cup Contact, C04 Mounting Hole	PE44077	\$19.40	\$18.04	\$16.68	\$15.52	20
		4 Hole Flange, .100" X .120" Tab Contact, A05 Mounting Hole	PE4492	\$18.75	\$17.44	\$16.13	\$15.00	21
		4 Hole Flange, .050" Dia. Stub Contact, .590" Extended Dielectric, .500" Flange Size, A01 Mounting Hole	PE4355	\$14.69	\$13.66	\$12.63	\$11.75	22
		4 Hole Flange, .120" Dia Stub Contact, .590" Extended Dielectric, A05 Mounting Hole	PE4328	\$14.44	\$13.43	\$12.42	\$11.55	23
		4 Hole Flange, .050" Dia. Stub Contact, .590" Extended Dielectric, .687" Flange Size, A04 Mounting Hole	PE4444	\$16.26	\$15.12	\$13.98	\$13.01	24
		4 Hole Flange, Solder Cup Contact, A05 Mounting Hole	PE4013	\$9.53	\$8.86	\$8.20	\$7.62	25
4 Hole Flange, Solder Cup Contact, Hermetically Sealed w/o-ring, A05 Mounting Hole	PE4487	\$41.14	\$38.26	\$35.38	\$32.91	26		
Female Right Angle, Panel Mount, Terminal								
	Solder	4 Hole Flange, Solder Cup Contact, A05 Mounting Hole	PE4486	\$34.86	\$32.42	\$29.98	\$27.89	27
Female Straight, Press In Mount, Terminal								
	Solder	.005" X .120" Tab Contact, F02 Mounting Hole	PE44075	\$22.34	\$20.78	\$19.21	\$17.87	28
		.050" Dia. Stub Contact, F02 Mounting Hole	PE44074	\$19.91	\$18.52	\$17.12	\$15.93	29
		Solder Cup Contact, F02 Mounting Hole	PE44076	\$11.60	\$10.79	\$9.98	\$9.28	30
Female Straight, PCB Mount								
	Solder	Surface Mount Edge Launch, G01 Mounting Hole	PE44615	\$21.33	\$19.84	\$18.34	\$17.06	31
		.050" Dia. Contact, .155" Leg Length, Thru Hole, D12 Mounting Hole	PE44396	\$18.75	\$17.44	\$16.13	\$15.00	32

Connectors





See Our Website For Real-Time Stock Availability!

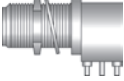

N Connectors

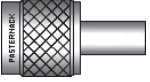
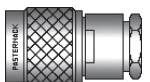
Product Image	Attachment Cable/Contact	Coax Type / Termination Type	Model No.	Price				Row
				1-24	25-49	50-99	100 +	
Female Straight, Bulkhead Mount, PCB Mount								
	Solder	.062" Dia. Contact, .125" Leg Length, .700" Max Panel, Thru Hole, D12 & G01 Mounting Hole	PE44397	\$24.88	\$23.14	\$21.40	\$19.90	1
Female Right Angle, Bulkhead Mount, PCB Mount								
	Solder	.062" Dia. Contact, .125" Leg Length, .350" Max Panel, Thru Hole, D12 & B15 Mounting Hole	PE44398	\$19.71	\$18.33	\$16.95	\$15.77	2



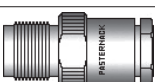



TNC Connectors

Product Image	Attachment Cable/Contact	Coax Type / Termination Type	Model No.	Price				Row
				1-24	25-49	50-99	100 +	
Male Straight, Cable Connectors								
	Crimp/Solder	RG8X, PE-C240	PE44634	\$10.74	\$9.99	\$9.24	\$8.59	3
		PE-B400, PE-B405, PE-C400	PE44293	\$23.15	\$21.53	\$19.91	\$18.52	4
		PE-C200	PE44062	\$13.15	\$12.23	\$11.31	\$10.52	5
		RG174, RG316, RG188	PE4302	\$15.20	\$14.14	\$13.07	\$12.16	6
		RG213, RG8	PE4446	\$14.35	\$13.35	\$12.34	\$11.48	7
		RG214, RG9, RG225, RG393	PE4447	\$20.61	\$19.17	\$17.72	\$16.49	8
		RG58	PE4156	\$8.35	\$7.77	\$7.18	\$6.68	9
		RG59, RG62	PE4071	\$8.61	\$8.01	\$7.40	\$6.89	10
	Clamp/Solder	RG55, RG141, RG142, RG223, RG400	PE4047	\$10.18	\$9.47	\$8.75	\$8.14	11
		RG8X, PE-C240	PE44063	\$13.43	\$12.49	\$11.55	\$10.74	12
		PE-B400, PE-B405, PE-C400	PE4449	\$15.96	\$14.84	\$13.73	\$12.77	13
		PE-C200	PE44061	\$13.15	\$12.23	\$11.31	\$10.52	14
		PE-C300	PE44064	\$14.35	\$13.35	\$12.34	\$11.48	15
		PE-SR402AL, PE-SR402FL, RG402, .141" Semi-Rigid	PE4143	\$16.45	\$15.30	\$14.15	\$13.16	16
		PE-SR405AL, PE-SR405FL, RG405, .085" Semi-Rigid	PE4142	\$16.45	\$15.30	\$14.15	\$13.16	17
		RG174, RG316, RG188	PE4303	\$11.70	\$10.88	\$10.06	\$9.36	18
		RG178, RG196	PE4448	\$14.35	\$13.35	\$12.34	\$11.48	19
		RG213, RG214, RG8, RG9, RG225, RG393, RG11	PE4088	\$13.98	\$13.00	\$12.02	\$11.18	20
		RG58, RG55, RG141, RG142, RG400, RG223	PE4067	\$18.62	\$17.32	\$16.01	\$14.90	21
RG59, RG62	PE4154	\$11.30	\$10.51	\$9.72	\$9.04	22		
	Solder/Solder	PE-047SR, PE-SR047AL, PE-SR047FL, .047" Semi-Rigid	PE4975	\$20.77	\$19.32	\$17.86	\$16.62	23
		PE-SR401AL, PE-SR401FL, RG401, .250" Semi-Rigid	PE4909	\$46.05	\$42.83	\$39.60	\$36.84	24
		PE-SR402AL, PE-SR402FL, RG402, .141" Semi-Rigid	PE4648	\$22.24	\$20.68	\$19.13	\$17.79	25
		PE-SR405AL, PE-SR405FL, RG405, .085" Semi-Rigid	PE4649	\$20.87	\$19.41	\$17.95	\$16.70	26
Male Right Angle, Cable Connectors								
	Crimp/Solder	RG8X, PE-C240	PE44635	\$19.25	\$17.90	\$16.56	\$15.40	27
		RG174, RG316, RG188	PE4455	\$19.04	\$17.71	\$16.37	\$15.23	28
		RG58	PE4451	\$18.36	\$17.07	\$15.79	\$14.69	29
		RG59, RG62	PE4453	\$18.24	\$16.96	\$15.69	\$14.59	30
	Clamp/Solder	RG55, RG141, RG142, RG223, RG400	PE4450	\$20.50	\$19.07	\$17.63	\$16.40	31
		RG174, RG316, RG188	PE4454	\$16.75	\$15.58	\$14.41	\$13.40	32
		RG178, RG196	PE4456	\$20.45	\$19.02	\$17.59	\$16.36	33
		RG213, RG214, RG8, RG9, RG225, RG393, RG11	PE4146	\$25.38	\$23.60	\$21.83	\$20.30	34
		RG58, RG55, RG141, RG142, RG400, RG223	PE4054	\$19.66	\$18.28	\$16.91	\$15.73	35
RG59, RG62	PE4452	\$25.84	\$24.03	\$22.22	\$20.67	36		
Female Straight, Cable Connectors								
	Crimp/Solder	RG8X, PE-C240	PE44636	\$12.87	\$11.97	\$11.07	\$10.30	37
		RG174, RG316, RG188	PE4462	\$14.08	\$13.09	\$12.11	\$11.26	38
		RG58	PE4458	\$11.17	\$10.39	\$9.61	\$8.94	39
		RG59, RG62	PE4459	\$11.60	\$10.79	\$9.98	\$9.28	40
	Clamp/Solder	RG55, RG141, RG142, RG223, RG400	PE4457	\$11.35	\$10.56	\$9.76	\$9.08	41
		PE-SR402AL, PE-SR402FL, RG402, .141" Semi-Rigid	PE4145	\$16.75	\$15.58	\$14.41	\$13.40	42

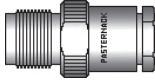
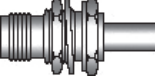
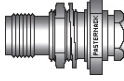
Connectors

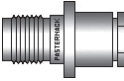
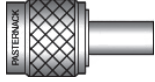
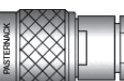
See Our Website For Real-Time Stock Availability!

TNC Connectors

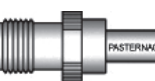
Product Image	Attachment Cable/Contact	Coax Type / Termination Type	Model No.	Price				Row
				1-24	25-49	50-99	100 +	
	Clamp/Solder	PE-SR405AL, PE-SR405FL, RG405, .085" Semi-Rigid	PE4144	\$16.75	\$15.58	\$14.41	\$13.40	1
		RG174, RG316, RG188	PE4461	\$11.70	\$10.88	\$10.06	\$9.36	2
		RG178, RG196	PE4463	\$13.15	\$12.23	\$11.31	\$10.52	3
		RG213, RG214, RG8, RG9, RG225, RG393, RG11	PE4155	\$25.84	\$24.03	\$22.22	\$20.67	4
		RG58, RG55, RG141, RG142, RG400, RG223	PE4068	\$9.58	\$8.91	\$8.24	\$7.66	5
		RG59, RG62	PE4460	\$11.60	\$10.79	\$9.98	\$9.28	6
Female Straight, Bulkhead Mount, Cable Connectors								
	Crimp/Solder	RG174, RG316, RG188, B06 Mounting Hole	PE4466	\$18.67	\$17.36	\$16.06	\$14.94	7
		RG58, B06 Mounting Hole	PE4151	\$14.14	\$13.15	\$12.16	\$11.31	8
		RG59, RG62, B06 Mounting Hole	PE4465	\$18.24	\$16.96	\$15.69	\$14.59	9
		RG55, RG141, RG142, RG223, RG400, B06 Mounting Hole	PE4153	\$14.75	\$13.72	\$12.69	\$11.80	10
	Clamp/Solder	PE-SR402AL, PE-SR402FL, RG402, B06 Mounting Hole, .141" Semi-Rigid	PE4150	\$20.05	\$18.65	\$17.24	\$16.04	11
		PE-SR405AL, PE-SR405FL, RG405, B06 Mounting Hole, .085" Semi-Rigid	PE4149	\$20.05	\$18.65	\$17.24	\$16.04	12
		RG174, RG316, RG188, B06 Mounting Hole	PE4304	\$16.45	\$15.30	\$14.15	\$13.16	13
		RG178, RG196, B06 Mounting Hole	PE4467	\$16.75	\$15.58	\$14.41	\$13.40	14
		RG58, RG55, RG141, RG142, RG400, RG223, B06 Mounting Hole	PE4152	\$14.69	\$13.66	\$12.63	\$11.75	15
		RG59, RG62, B06 Mounting Hole	PE4464	\$22.34	\$20.78	\$19.21	\$17.87	16
	Solder/Solder	PE-SR402AL, PE-SR402FL, RG402, Precision, B06 Mounting Hole, .141" Semi-Rigid	PE4148	\$50.01	\$46.51	\$43.01	\$40.01	17
		PE-SR405AL, PE-SR405FL, RG405, Precision, B06 Mounting Hole, .085" Semi-Rigid	PE4147	\$53.60	\$49.85	\$46.10	\$42.88	18
Female Straight, Panel Mount, Cable Connectors								
	Clamp/Solder	4 Hole Flange, RG58, RG55, RG141, RG142, RG223, RG400, A03 Mounting Hole	PE4066	\$12.21	\$11.36	\$10.50	\$9.77	19
Reverse Polarity Male Straight, Cable Connectors								
	Crimp/Solder	RG8X, PE-C240	PE44670	\$13.93	\$12.95	\$11.98	\$11.14	20
		PE-C400	PE44672	\$17.12	\$15.92	\$14.72	\$13.70	21
		RG174, RG316, RG188	PE4668	\$17.18	\$15.98	\$14.77	\$13.74	22
		RG213, RG8	PE4660	\$17.95	\$16.69	\$15.44	\$14.36	23
		RG214, RG9	PE4661	\$19.40	\$18.04	\$16.68	\$15.52	24
		RG58	PE4664	\$9.60	\$8.93	\$8.26	\$7.68	25
		RG59, RG62	PE4666	\$10.34	\$9.62	\$8.89	\$8.27	26
	Clamp/Solder	RG55, RG141, RG142, RG223, RG400	PE4663	\$10.28	\$9.56	\$8.84	\$8.22	27
		PE-B400, PE-B405	PE4674	\$18.39	\$17.10	\$15.82	\$14.71	28
		PE-SR402AL, PE-SR402FL, RG402, .141" Semi-Rigid	PE4670	\$18.80	\$17.48	\$16.17	\$15.04	29
		PE-SR405AL, PE-SR405FL, RG405, .085" Semi-Rigid	PE4672	\$18.80	\$17.48	\$16.17	\$15.04	30
		RG174, RG316, RG188	PE4667	\$17.85	\$16.60	\$15.35	\$14.28	31
		RG178, RG196	PE4669	\$16.75	\$15.58	\$14.41	\$13.40	32
		RG213, RG214, RG8, RG9, RG225, RG393,	PE4659	\$18.24	\$16.96	\$15.69	\$14.59	33
		RG58, RG55, RG141, RG142, RG400, RG223	PE4662	\$9.73	\$9.05	\$8.37	\$7.78	34
		RG59, RG62	PE4665	\$10.99	\$10.22	\$9.45	\$8.79	35
		PE-SR402AL, PE-SR402FL, RG402, .141" Semi-Rigid	PE4671	\$24.72	\$22.99	\$21.26	\$19.78	36
	Solder/Solder	PE-SR405AL, PE-SR405FL, RG405, .085" Semi-Rigid	PE4673	\$24.72	\$22.99	\$21.26	\$19.78	37
Reverse Polarity Male Right Angle, Cable Connectors								
	Crimp/Solder	RG316, RG174, RG188	PE4681	\$22.09	\$20.54	\$19.00	\$17.67	38
		RG58	PE4678	\$19.66	\$18.28	\$16.91	\$15.73	39
		RG55, RG141, RG142, RG223, RG400	PE4677	\$19.10	\$17.76	\$16.43	\$15.28	40
	Clamp/Solder	RG178, RG196	PE4682	\$22.30	\$20.74	\$19.18	\$17.84	41
		RG213, RG214, RG8, RG9, RG225, RG393,	PE4675	\$33.64	\$31.29	\$28.93	\$26.91	42
		RG316, RG174, RG188	PE4680	\$18.80	\$17.48	\$16.17	\$15.04	43
		RG58, RG55, RG141, RG142, RG400, RG223	PE4676	\$23.41	\$21.77	\$20.13	\$18.73	44
		RG59, RG62	PE4679	\$24.72	\$22.99	\$21.26	\$19.78	45
Reverse Polarity Female Straight, Cable Connectors								
	Crimp/Solder	RG8X, PE-C240	PE44671	\$15.05	\$14.00	\$12.94	\$12.04	46
		PE-C400	PE44673	\$19.25	\$17.90	\$16.56	\$15.40	47
		RG316, RG174, RG188	PE4690	\$15.60	\$14.51	\$13.42	\$12.48	48
		RG58	PE4686	\$12.21	\$11.36	\$10.50	\$9.77	49







Connectors

See Our Website For Real-Time Stock Availability!

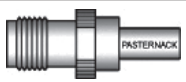
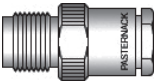
TNC Connectors

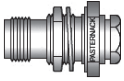
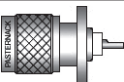
Connectors

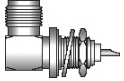
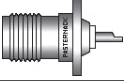
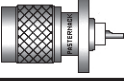

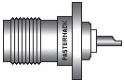
See Our Website For Real-Time Stock Availability!

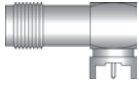

Product Image	Attachment Cable/Contact	Coax Type / Termination Type	Model No.	Price				Row
				1-24	25-49	50-99	100 +	
	Crimp/Solder	RG59, RG62	PE4687	\$14.24	\$13.24	\$12.25	\$11.39	1
		RG55, RG141, RG142, RG223, RG400	PE4685	\$11.90	\$11.07	\$10.23	\$9.52	2
	Clamp/Solder	PE-SR402AL, PE-SR402FL, RG402, .141" Semi-Rigid	PE4692	\$19.10	\$17.76	\$16.43	\$15.28	3
		PE-SR405AL, PE-SR405FL, RG405, .085" Semi-Rigid	PE4693	\$18.80	\$17.48	\$16.17	\$15.04	4
		RG178, RG196	PE4691	\$15.35	\$14.28	\$13.20	\$12.28	5
		RG213, RG214, RG8, RG9, RG225, RG393,	PE4683	\$29.94	\$27.84	\$25.75	\$23.95	6
		RG316, RG174, RG188	PE4689	\$14.10	\$13.11	\$12.13	\$11.28	7
		RG58, RG55, RG141, RG142, RG400, RG223	PE4684	\$12.97	\$12.06	\$11.15	\$10.38	8
		RG59, RG62	PE4688	\$18.64	\$17.34	\$16.03	\$14.91	9
		Reverse Polarity Female Straight, Bulkhead Mount, Cable Connectors						
	Crimp/Solder	RG316, RG174, RG188, B06 Mounting Hole	PE4700	\$19.66	\$18.28	\$16.91	\$15.73	10
		RG58, B06 Mounting Hole	PE4696	\$20.57	\$19.13	\$17.69	\$16.46	11
		RG59, RG62, B06 Mounting Hole	PE4698	\$20.77	\$19.32	\$17.86	\$16.62	12
		RG55, RG141, RG142, RG223, RG400, B06 Mounting Hole	PE4695	\$15.60	\$14.51	\$13.42	\$12.48	13
	Clamp/Solder	PE-SR402AL, PE-SR402FL, RG402, B06 Mounting Hole, .141" Semi-Rigid	PE4702	\$22.30	\$20.74	\$19.18	\$17.84	14
		PE-SR405AL, PE-SR405FL, RG405, B06 Mounting Hole, .085" Semi-Rigid	PE4703	\$22.30	\$20.74	\$19.18	\$17.84	15
		RG178, RG196, B06 Mounting Hole	PE4701	\$19.10	\$17.76	\$16.43	\$15.28	16
		RG316, RG174, RG188, B06 Mounting Hole	PE4699	\$18.80	\$17.48	\$16.17	\$15.04	17
		RG58, RG55, RG141, RG142, RG400, RG223, B06 Mounting Hole	PE4694	\$17.18	\$15.98	\$14.77	\$13.74	18
		RG59, RG62, B06 Mounting Hole	PE4697	\$20.77	\$19.32	\$17.86	\$16.62	19
Male Straight, Panel Mount, Terminal								
	Solder	4 Hole Flange, .050" Dia. Stub Contact, .590" Extended Dielectric, A07 Mounting Hole	PE44654	\$51.83	\$48.20	\$44.57	\$41.46	20
		4 Hole Flange, Solder Cup Contact, A07 Mounting Hole	PE4470	\$14.69	\$13.66	\$12.63	\$11.75	21
Female Straight, Bulkhead Mount, Terminal								
	Solder	Solder Cup Contact, .200 Max Panel, B04 Mounting Hole	PE4065	\$9.73	\$9.05	\$8.37	\$7.78	22
		Solder Cup Contact, .125" Max Panel, B05 Mounting Hole	PE4063	\$16.42	\$15.27	\$14.12	\$13.14	23
		Wire Terminal, Front Mount, Hermetically Sealed, .300" Max Panel, B04 Mounting Hole	PE4305	\$23.96	\$22.28	\$20.61	\$19.17	24
		Wire Terminal, Rear Mount, Hermetically Sealed, .250" Max Panel, B06 Mounting Hole	PE4469	\$30.96	\$28.79	\$26.63	\$24.77	25
		Solder Cup Contact, Isolated Ground, .125" Max Panel, B04 Mounting Hole	PE4306	\$11.60	\$10.79	\$9.98	\$9.28	26
		Solder Cup Contact, Isolated Ground, .180" Max Panel, B06 Mounting Hole	PE4468	\$12.21	\$11.36	\$10.50	\$9.77	27
Female Right Angle, Bulkhead Mount, Terminal								
	Solder	Solder Cup Contact, .275" Max Panel, B13 Mounting Hole	PE4471	\$22.09	\$20.54	\$19.00	\$17.67	28
Female Straight, Panel Mount, Terminal								
	Solder	4 Hole Flange, Solder Cup Contact, A03 Mounting Hole	PE4064	\$9.93	\$9.23	\$8.54	\$7.94	29
Reverse Polarity Male Straight, Panel Mount, Terminal								
	Solder	4 Hole Flange, Solder Cup Contact, A07 Mounting Hole	PE4708	\$17.18	\$15.98	\$14.77	\$13.74	30
Reverse Polarity Female Straight, Bulkhead Mount, Terminal								
	Solder	Solder Cup Contact, .125" Max Panel, B05 Mounting Hole	PE4704	\$12.97	\$12.06	\$11.15	\$10.38	31
		Solder Cup Contact, .150" Max Panel, B04 Mounting Hole	PE4706	\$12.97	\$12.06	\$11.15	\$10.38	32
		Solder Cup Contact, Isolated Ground, .180" Max Panel, B06 Mounting Hole	PE4707	\$17.48	\$16.26	\$15.03	\$13.98	33
Reverse Polarity Female Straight, Panel Mount, Terminal								
	Solder	4 Hole Flange, Solder Cup Contact, A03 Mounting Hole	PE4705	\$17.48	\$16.26	\$15.03	\$13.98	34

TNC Connectors

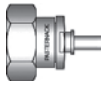
Product Image	Attachment Cable/Contact	Coax Type / Termination Type	Model No.	Price				Row
				1-24	25-49	50-99	100 +	
Female Right Angle, PCB Mount								
	Solder	.035" Dia. Contact, .118" Leg Length, Thru Hole, D17 Mounting Hole	PE44659	\$11.75	\$10.93	\$10.11	\$9.40	1

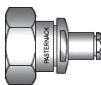
7/16 DIN Connectors

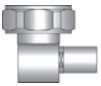
Product Image	Attachment Cable/Contact	Coax Type / Termination Type	Model No.	Price				Row
				1-24	25-49	50-99	100 +	
Male Straight, Cable Connectors								
	Crimp/Solder	PE-C195	PE44536	\$35.77	\$33.27	\$30.76	\$28.62	2
		PE-C240	PE44537	\$35.77	\$33.27	\$30.76	\$28.62	3
		PE-C400	PE44538	\$42.66	\$39.67	\$36.69	\$34.13	4
		PE-C600	PE44539	\$47.73	\$44.39	\$41.05	\$38.18	5
		RG213, RG8	PE4570	\$88.80	\$82.58	\$76.37	\$71.04	6
		RG214, RG9, RG225, RG393	PE4571	\$86.33	\$80.29	\$74.24	\$69.06	7
		RG58	PE4569	\$81.75	\$76.03	\$70.31	\$65.40	8
		RG55, RG142, RG223, RG400	PE4568	\$84.56	\$78.64	\$72.72	\$67.65	9
			Clamp	1/4 inch Super Flexible, Precision, Low PIM	PE44728	\$54.31	\$50.51	\$46.71
1/2 inch Flexible, Precision, Low PIM	PE44738			\$27.83	\$25.88	\$23.93	\$22.26	11
1/2 inch Super Flexible, Precision, Low PIM	PE44732			\$27.83	\$25.88	\$23.93	\$22.26	12
	Clamp/Solder	PE-SR401AL, PE-SR401FL, RG401, .250" Semi-Rigid	PE44278	\$102.50	\$95.33	\$88.15	\$82.00	13
		PE-SR402AL, PE-SR402FL, RG402, .141" Semi-Rigid	PE44279	\$102.50	\$95.33	\$88.15	\$82.00	14
		1/2" Helical, Low PIM	PE44557	\$48.84	\$45.42	\$42.00	\$39.07	15
		1/2" Annular, Low PIM	PE44567	\$47.73	\$44.39	\$41.05	\$38.18	16
		7/8" Annular, Low PIM	PE44568	\$65.66	\$61.06	\$56.47	\$52.53	17
		7/8" Helical, Low PIM	PE44558	\$65.66	\$61.06	\$56.47	\$52.53	18
		RG14, RG217	PE44276	\$105.99	\$98.57	\$91.15	\$84.79	19
		RG213, RG214, RG8, RG9, RG225, RG393, RG218	PE4567	\$71.34	\$66.35	\$61.35	\$57.07	20
		RG218	PE44277	\$114.10	\$106.11	\$98.13	\$91.28	21
		RG58, RG55, RG141, RG142, RG400, RG223	PE4566	\$99.76	\$92.78	\$85.79	\$79.81	22

Male Right Angle, Cable Connectors								
	Crimp/Solder	PE-C195	PE44540	\$47.73	\$44.39	\$41.05	\$38.18	23
		PE-C240	PE44541	\$52.49	\$48.82	\$45.14	\$41.99	24
		PE-C400	PE44542	\$50.72	\$47.17	\$43.62	\$40.58	25
		PE-C600	PE44543	\$59.63	\$55.46	\$51.28	\$47.70	26
	Clamp/Solder	1/2" Helical, Low PIM	PE44559	\$59.63	\$55.46	\$51.28	\$47.70	27
		1/2" Annular, Low PIM	PE44569	\$59.63	\$55.46	\$51.28	\$47.70	28
		RG14, RG217	PE44282	\$149.66	\$139.18	\$128.71	\$119.73	29
		RG213, RG214, RG8, RG9, RG225, RG393, RG58, RG55, RG141, RG142, RG400, RG223	PE44280	\$114.81	\$106.77	\$98.74	\$91.85	30
			PE44281	\$149.66	\$139.18	\$128.71	\$119.73	31

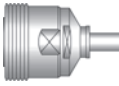
Female Straight, Cable Connectors								
	Clamp	1/2 inch Flexible, Precision, Low PIM	PE44740	\$27.83	\$25.88	\$23.93	\$22.26	32
		1/2 inch Super Flexible, Precision, Low PIM	PE44734	\$27.83	\$25.88	\$23.93	\$22.26	33
	Crimp/Solder	PE-C195	PE44544	\$47.73	\$44.39	\$41.05	\$38.18	34
		PE-C240	PE44545	\$47.73	\$44.39	\$41.05	\$38.18	35
		PE-C400	PE44546	\$53.65	\$49.89	\$46.14	\$42.92	36
		PE-C600	PE44547	\$59.63	\$55.46	\$51.28	\$47.70	37
		RG213, RG8	PE44284	\$96.80	\$90.02	\$83.25	\$77.44	38
		RG214, RG9, RG225, RG393	PE4575	\$105.94	\$98.52	\$91.11	\$84.75	39
		RG58	PE44287	\$84.10	\$78.21	\$72.33	\$67.28	40
		RG55, RG142, RG223, RG400	PE44286	\$112.22	\$104.36	\$96.51	\$89.78	41

Connectors

See Our Website For Real-Time Stock Availability!

7/16 DIN Connectors

Connectors

Product Image	Attachment Cable/Contact	Coax Type / Termination Type	Model No.	Price				Row
				1-24	25-49	50-99	100 +	
	Clamp/Solder	PE-SR401AL, PE-SR401FL, RG401, .250" Semi-Rigid	PE44289	\$95.05	\$88.40	\$81.74	\$76.04	1
		PE-SR402AL, PE-SR402FL, RG402, .141" Semi-Rigid	PE44290	\$95.05	\$88.40	\$81.74	\$76.04	2
		1/2" Helical, Low PIM	PE44560	\$53.65	\$49.89	\$46.14	\$42.92	3
		1/2" Annular, Low PIM	PE44570	\$47.73	\$44.39	\$41.05	\$38.18	4
		7/8" Annular, Low PIM	PE44571	\$59.63	\$55.46	\$51.28	\$47.70	5
		7/8" Helical, Low PIM	PE44561	\$65.66	\$61.06	\$56.47	\$52.53	6
		RG14, RG217	PE44288	\$104.78	\$97.45	\$90.11	\$83.82	7
		RG213, RG214, RG8, RG9, RG225, RG393	PE44283	\$112.22	\$104.36	\$96.51	\$89.78	8
		RG58, RG55, RG141, RG142, RG400, RG223	PE44285	\$112.22	\$104.36	\$96.51	\$89.78	9

Female Straight, Bulkhead Mount, Cable Connectors

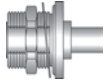
	Crimp/Solder	PE-C195, G08 Mounting Hole	PE44548	\$53.65	\$49.89	\$46.14	\$42.92	10
		PE-C240, G08 Mounting Hole	PE44549	\$53.65	\$49.89	\$46.14	\$42.92	11
		PE-C400, G08 Mounting Hole	PE44550	\$59.63	\$55.46	\$51.28	\$47.70	12
		PE-C600, G08 Mounting Hole	PE44551	\$65.66	\$61.06	\$56.47	\$52.53	13
		RG55, RG142, RG223, RG400, G08 Mounting Hole	PE44656	\$53.45	\$49.71	\$45.97	\$42.76	14

Female Straight, Panel Mount, Cable Connectors

	Clamp/Solder	4 Hole Flange, RG14, RG217, A21 Mounting Hole	PE44292	\$124.69	\$115.96	\$107.23	\$99.75	15
		4 Hole Flange, RG213, RG214, RG8, RG9, RG225, RG393, A21 Mounting Hole	PE44291	\$124.69	\$115.96	\$107.23	\$99.75	16



Female Straight, Bulkhead Mount, Terminal

	Solder	Solder Cup Contact, Rear Mount, .197" Max Panel	PE4572	\$124.69	\$115.96	\$107.23	\$99.75	17
---	--------	---	--------	----------	----------	----------	---------	----

Female Straight, Panel Mount, Terminal

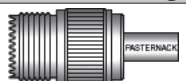
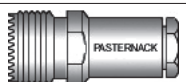

	Solder	4 Hole Flange, Pin, A21 Mounting Hole	PE4574	\$70.68	\$65.73	\$60.78	\$56.54	18
		4 Hole Flange, Solder Cup Contact, A21 Mounting Hole	PE4573	\$70.68	\$65.73	\$60.78	\$56.54	19

UHF Connectors





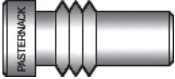

Product Image	Attachment Cable/Contact	Coax Type / Termination Type	Model No.	Price				Row
				1-24	25-49	50-99	100 +	
Male Straight, Cable Connectors								
	Crimp/Solder	PE-B400, PE-B405, PE-C400	PE44054	\$9.07	\$8.44	\$7.80	\$7.26	20
		RG213, RG8	PE4295	\$11.22	\$10.43	\$9.65	\$8.98	21
		RG214, RG9, RG225, RG393	PE44051	\$9.60	\$8.93	\$8.26	\$7.68	22
		RG58	PE4069	\$5.82	\$5.41	\$5.01	\$4.66	23
		RG59, RG62	PE4073	\$6.03	\$5.61	\$5.19	\$4.82	24
	Clamp/Solder	RG55, RG141, RG142, RG223, RG400	PE44053	\$6.80	\$6.32	\$5.85	\$5.44	25
		RG213, RG214, RG8, RG9, RG11, RG225, RG393	PE44050	\$8.77	\$8.16	\$7.54	\$7.02	26
	Solder/Solder	RG213, RG214, RG8, RG9, RG225, RG393,	PE4020	\$10.75	\$10.00	\$9.25	\$8.60	28
Female Straight, Cable Connectors								
	Crimp/Solder	RG58	PE44058	\$11.60	\$10.79	\$9.98	\$9.28	29
		RG55, RG141, RG142, RG223, RG400	PE44057	\$10.80	\$10.04	\$9.29	\$8.64	30
	Clamp/Solder	RG213, RG214, RG8, RG9, RG11, RG225, RG393	PE44055	\$10.99	\$10.22	\$9.45	\$8.79	31
		RG58, RG55, RG141, RG142, RG400, RG223	PE44056	\$11.60	\$10.79	\$9.98	\$9.28	32

See Our Website For Real-Time Stock Availability!

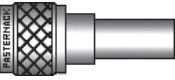
UHF Connectors

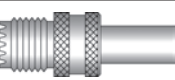
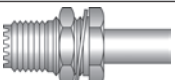
Product Image	Attachment Cable/Contact	Coax Type / Termination Type	Model No.	Price				Row
				1-24	25-49	50-99	100 +	
Sexless Straight, Accessories, Cable Connectors								
	Accessories	RG58, Use with PE4020	PE4022	\$1.21	\$1.13	\$1.04	\$0.97	1
		RG59, Use with PE4020	PE4021	\$1.26	\$1.17	\$1.08	\$1.01	2
Female Straight, Bulkhead Mount, Terminal								
	Solder	Solder Cup Contact, Rear Mount, .090" Max Panel, B12 Mounting Hole	PE44060	\$7.75	\$7.21	\$6.67	\$6.20	3
		Solder Cup Contact, Front Mount, .080" Max Panel, B12 Mounting Hole	PE44059	\$8.02	\$7.46	\$6.90	\$6.42	4
Female Straight, Panel Mount, Terminal								
	Solder	4 Hole Flange, Solder Cup Contact, A05 Mounting Hole	PE4012	\$6.66	\$6.19	\$5.73	\$5.33	5

MINI UHF Connectors



Product Image	Attachment Cable/Contact	Coax Type / Termination Type	Model No.	Price				Row
				1-24	25-49	50-99	100 +	
Male Straight, Cable Connectors								
	Crimp/Solder	RG174, RG316, RG188	PE44090	\$9.07	\$8.44	\$7.80	\$7.26	6
		RG58	PE4342	\$4.97	\$4.62	\$4.27	\$3.98	7
		RG55, RG141, RG142, RG223, RG400	PE4521	\$4.80	\$4.46	\$4.13	\$3.84	8
		RG55, RG141, RG142, RG223, RG400, Push-On	PE44088	\$7.75	\$7.21	\$6.67	\$6.20	9
Male Right Angle, Cable Connectors								
	Crimp/Solder	RG58	PE44082	\$11.60	\$10.79	\$9.98	\$9.28	10
		RG55, RG141, RG142, RG223, RG400	PE44081	\$9.45	\$8.79	\$8.13	\$7.56	11
Female Straight, Cable Connectors								
	Crimp/Solder	RG174, RG316, RG188	PE44085	\$10.34	\$9.62	\$8.89	\$8.27	12
		RG58	PE44084	\$9.39	\$8.73	\$8.08	\$7.51	13
		RG55, RG141, RG142, RG223, RG400	PE44083	\$8.35	\$7.77	\$7.18	\$6.68	14
Female Straight, Bulkhead Mount, Cable Connectors								
	Crimp/Solder	RG58, B05 Mounting Hole	PE44087	\$10.70	\$9.95	\$9.20	\$8.56	15
		RG55, RG141, RG142, RG223, RG400, B05 Mounting Hole	PE44086	\$9.45	\$8.79	\$8.13	\$7.56	16
Female Straight, Bulkhead Mount, Terminal								
	Solder	Solder Cup Contact, Front Mount, .125" Max Panel, B04 Mounting Hole	PE44089	\$5.22	\$4.85	\$4.49	\$4.18	17
		Solder Cup Contact, Rear Mount, .125" Max Panel, B04 Mounting Hole	PE4644	\$5.22	\$4.85	\$4.49	\$4.18	18
Female Straight, Panel Mount, Terminal								
	Solder	4 Hole Flange, Solder Cup Contact, A18 Mounting Hole	PE44091	\$8.02	\$7.46	\$6.90	\$6.42	19
Female Straight, Bulkhead Mount, PCB Mount								
	Solder	.040" Dia Contact, .157" Leg Length, D05 & F05 Mounting Hole	PE44092	\$7.75	\$7.21	\$6.67	\$6.20	20

Connectors





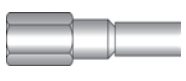
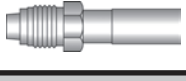



See Our Website For Real-Time Stock Availability!

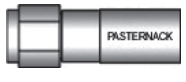

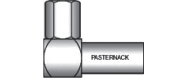
FME Connectors

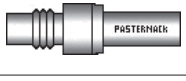
Product Image	Attachment Cable/Contact	Coax Type / Termination Type	Model No.	Price				Row
				1-24	25-49	50-99	100 +	
Plug Straight, Cable Connectors								
	Crimp/Solder	RG174, RG316, RG188	PE44297	\$8.56	\$7.96	\$7.36	\$6.85	1
		RG58	PE44295	\$9.07	\$8.44	\$7.80	\$7.26	2
		RG55, RG142, RG223, RG400	PE44296	\$8.35	\$7.77	\$7.18	\$6.68	3
Jack Straight, Cable Connectors								
	Crimp/Solder	RG174, RG316, RG188	PE44148	\$8.66	\$8.05	\$7.45	\$6.93	4
		RG58	PE44146	\$6.18	\$5.75	\$5.31	\$4.94	5
		RG55, RG142, RG223, RG400	PE44147	\$5.95	\$5.53	\$5.12	\$4.76	6
Plug Straight, Bulkhead Mount, Terminal								
	Solder	Solder Cup Contact, Front Mount, .175" Max Panel, B04 Mounting Hole	PE44149	\$6.43	\$5.98	\$5.53	\$5.14	7

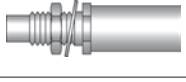





SMC Connectors

Product Image	Attachment Cable/Contact	Coax Type / Termination Type	Model No.	Price				Row
				1-24	25-49	50-99	100 +	
Plug Straight, Cable Connectors								
	Crimp/Solder	RG174, RG316, RG188	PE4045	\$9.28	\$8.63	\$7.98	\$7.42	8
		RG178, RG196	PE4074	\$12.90	\$12.00	\$11.09	\$10.32	9
		RG58	PE4558	\$17.63	\$16.40	\$15.16	\$14.10	10
		RG55, RG142, RG223, RG400	PE4594	\$17.00	\$15.81	\$14.62	\$13.60	11
	Clamp/Solder	PE-SR405AL, PE-SR405FL, RG405, .085" Semi-Rigid	PE4357	\$16.16	\$15.03	\$13.90	\$12.93	12
		RG174, RG316, RG188	PE4201	\$9.73	\$9.05	\$8.37	\$7.78	13
		RG178, RG196	PE4202	\$13.68	\$12.72	\$11.76	\$10.94	14
Plug Right Angle, Cable Connectors								
	Crimp/Solder	RG174, RG316, RG188	PE4051	\$12.90	\$12.00	\$11.09	\$10.32	15
		RG178, RG196	PE4160	\$12.21	\$11.36	\$10.50	\$9.77	16
		RG58	PE4557	\$15.96	\$14.84	\$13.73	\$12.77	17
		RG55, RG142, RG223, RG400	PE4596	\$15.60	\$14.51	\$13.42	\$12.48	18
	Clamp/Solder	PE-SR405AL, PE-SR405FL, RG405, .085" Semi-Rigid	PE4359	\$18.59	\$17.29	\$15.99	\$14.87	19
		RG174, RG316, RG188	PE4262	\$11.70	\$10.88	\$10.06	\$9.36	20
		RG178, RG196	PE4263	\$12.41	\$11.54	\$10.67	\$9.93	21
Jack Straight, Cable Connectors								
	Crimp/Solder	RG174, RG316, RG188	PE4094	\$12.41	\$11.54	\$10.67	\$9.93	22
		RG178, RG196	PE4927	\$13.68	\$12.72	\$11.76	\$10.94	23
	Clamp/Solder	PE-SR405AL, PE-SR405FL, RG405, .085" Semi-Rigid	PE4361	\$22.34	\$20.78	\$19.21	\$17.87	24
		RG174, RG316, RG188	PE4270	\$22.34	\$20.78	\$19.21	\$17.87	25
		RG178, RG196	PE4271	\$22.34	\$20.78	\$19.21	\$17.87	26
Jack Straight, Bulkhead Mount, Cable Connectors								
	Crimp/Solder	RG174, RG316, RG188, B01 Mounting Hole	PE4095	\$11.70	\$10.88	\$10.06	\$9.36	27
		RG178, RG196, B01 Mounting Hole	PE4365	\$23.66	\$22.00	\$20.35	\$18.93	28
		RG58, B01 Mounting Hole	PE44095	\$20.50	\$19.07	\$17.63	\$16.40	29
		RG55, RG142, RG223, RG400, B01 Mounting Hole	PE44047	\$21.13	\$19.65	\$18.17	\$16.90	30
	Clamp/Solder	PE-SR405AL, PE-SR405FL, RG405, B01 Mounting Hole, .085" Semi-Rigid	PE4363	\$24.88	\$23.14	\$21.40	\$19.90	31
		RG174, RG316, RG188, B01 Mounting Hole	PE4278	\$24.88	\$23.14	\$21.40	\$19.90	32
		RG178, RG196, B01 Mounting Hole	PE4279	\$24.88	\$23.14	\$21.40	\$19.90	33

Connectors

See Our Website For Real-Time Stock Availability!

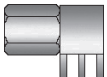
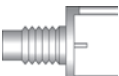
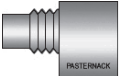
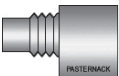
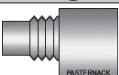
SMC Connectors

Product Image	Attachment Cable/Contact	Coax Type / Termination Type	Model No.	Price				Row
				1-24	25-49	50-99	100 +	
Plug Straight, Bulkhead Mount, Terminal								
	Solder	Solder Cup Contact, Front Mount, .093" Max Panel, B01 Mounting Hole	PE4289	\$16.16	\$15.03	\$13.90	\$12.93	1
Jack Straight, Bulkhead Mount, Terminal								
	Solder	Solder Cup Contact, Front Mount, .093" Max Panel, B01 Mounting Hole	PE4171	\$9.70	\$9.02	\$8.34	\$7.76	2
		Solder Cup Contact, Rear Mount, .093" Max Panel, B01 Mounting Hole	PE4107	\$9.70	\$9.02	\$8.34	\$7.76	3
Jack Right Angle, Bulkhead Mount, Terminal								
	Solder	Solder Cup Contact, .100" Max Panel, B01 Mounting Hole	PE4285	\$22.44	\$20.87	\$19.30	\$17.95	4
Jack Straight, Panel Mount, Terminal								
	Solder	2 Hole Flange, Solder Cup Contact, C07 Mounting Hole	PE44140	\$15.35	\$14.28	\$13.20	\$12.28	5
		4 Hole Flange, Solder Cup Contact, A22 Mounting Hole	PE44143	\$15.30	\$14.23	\$13.16	\$12.24	6
Plug Straight, PCB Mount								
	Solder	.036" Dia. Contact, .142" Leg Length, Thru Hole, D02 Mounting Hole	PE4367	\$11.20	\$10.42	\$9.63	\$8.96	7
Plug Right Angle, PCB Mount								
	Solder	.040" Dia. Contact, .166" Leg Length, Thru Hole, D02 Mounting Hole	PE4246	\$21.13	\$19.65	\$18.17	\$16.90	8
Jack Straight, PCB Mount								
	Solder	.042" End Launch, .030" Round Contact	PE44133	\$19.91	\$18.52	\$17.12	\$15.93	9
		.042" End Launch, .020" x .010" Tab Contact	PE44138	\$19.91	\$18.52	\$17.12	\$15.93	10
		.062" End Launch, .020" x .010" Tab Contact	PE44136	\$19.00	\$17.67	\$16.34	\$15.20	11
		.062" End Launch, .030" Round Contact	PE44130	\$37.34	\$34.73	\$32.11	\$29.87	12
		Surface Mount	PE44120	\$12.36	\$11.49	\$10.63	\$9.89	13
		.037" Dia. Contact, .155" Leg Length, Thru Hole, D02 Mounting Hole	PE4175	\$6.64	\$6.18	\$5.71	\$5.31	14
Jack Right Angle, PCB Mount								
	Solder	Surface Mount	PE44122	\$10.34	\$9.62	\$8.89	\$8.27	15
Jack Right Angle, Bulkhead Mount, PCB Mount								
	Solder	.038" Dia. Contact, .155" Leg Length, .093" Max Panel, Thru Hole, B01 & D01 Mounting Hole	PE44127	\$15.96	\$14.84	\$13.73	\$12.77	16
Jack Right Angle, PCB Mount								
	Solder	.038" Dia. Contact, .155" Leg Length, Thru Hole, D02 Mounting Hole	PE4178	\$11.22	\$10.43	\$9.65	\$8.98	17
Jack Straight, Bulkhead Mount, PCB Mount								
	Solder	.038" Dia. Contact, .155" Leg Length, .093" Max Panel, Thru Hole, B01 Mounting Hole	PE44124	\$20.06	\$18.66	\$17.25	\$16.05	18

Connectors









See Our Website For Real-Time Stock Availability!

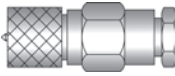

10-32 Connectors

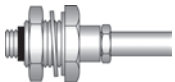
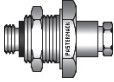
Connectors



See Our Website For Real-Time Stock Availability!

Product Image	Attachment Cable/Contact	Coax Type / Termination Type	Model No.	Price				Row
				1-24	25-49	50-99	100 +	
Male Straight, Cable Connectors								
	Crimp/Solder	RG174, RG316, RG188	PE44351	\$16.57	\$15.41	\$14.25	\$13.26	1
		RG178, RG196	PE44352	\$25.89	\$24.08	\$22.27	\$20.71	2
	Clamp/Solder	RG174, RG316, RG188	PE44353	\$24.42	\$22.71	\$21.00	\$19.54	3
		RG178, RG196	PE44354	\$24.88	\$23.14	\$21.40	\$19.90	4
Male Right Angle, Cable Connectors								
	Crimp/Solder	RG174, RG316, RG188	PE44355	\$18.75	\$17.44	\$16.13	\$15.00	5
		RG178, RG196	PE44356	\$23.66	\$22.00	\$20.35	\$18.93	6
Female Straight, Cable Connectors								
	Crimp/Solder	RG174, RG316, RG188	PE44361	\$21.13	\$19.65	\$18.17	\$16.90	7
		RG178, RG196	PE44362	\$21.13	\$19.65	\$18.17	\$16.90	8
	Clamp/Solder	RG174, RG316, RG188	PE44363	\$23.66	\$22.00	\$20.35	\$18.93	9
		RG178, RG196	PE44364	\$23.66	\$22.00	\$20.35	\$18.93	10
Female Straight, Bulkhead Mount, Cable Connectors								
	Crimp/Solder	RG174, RG316, RG188, B03 Mounting Hole	PE44365	\$24.88	\$23.14	\$21.40	\$19.90	11
		RG178, RG196, B03 Mounting Hole	PE44366	\$24.88	\$23.14	\$21.40	\$19.90	12
	Clamp/Solder	RG174, RG316, RG188, B03 Mounting Hole	PE44367	\$24.88	\$23.14	\$21.40	\$19.90	13
		RG178, RG196, B03 Mounting Hole	PE44368	\$24.88	\$23.14	\$21.40	\$19.90	14
Female Straight, Bulkhead Mount, Terminal								
	Solder	Solder Cup Contact, Front Mount, .150" Max Panel, B01 Mounting Hole	PE44357	\$18.75	\$17.44	\$16.13	\$15.00	15
		Solder Cup Contact, Rear Mount, .141" Max Panel, B03 Mounting Hole	PE44358	\$23.66	\$22.00	\$20.35	\$18.93	16
Female Straight, PCB Mount								
	Solder	.052" Dia. Contact, .155" Leg Length, Thru Hole, D01 Mounting Hole	PE44359	\$17.63	\$16.40	\$15.16	\$14.10	17
Female Right Angle, PCB Mount								
	Solder	.050" Dia. Contact, .155" Leg Length, Thru Hole, D01 Mounting Hole	PE44360	\$21.58	\$20.07	\$18.56	\$17.26	18

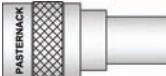
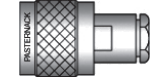

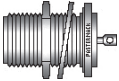

SC Connectors

Product Image	Attachment Cable/Contact	Coax Type / Termination Type	Model No.	Price				Row
				1-24	25-49	50-99	100 +	
Male Straight, Cable Connectors								
	Crimp/Solder	RG214, RG9, RG225, RG393	PE4232	\$46.81	\$43.53	\$40.26	\$37.45	19
		RG55, RG141, RG142, RG223, RG400	PE4231	\$87.30	\$81.19	\$75.08	\$69.84	20
	Clamp/Solder	RG14, RG217	PE4976	\$105.94	\$98.52	\$91.11	\$84.75	21
		RG213, RG214, RG8, RG9, RG225, RG393	PE4520	\$124.69	\$115.96	\$107.23	\$99.75	22
		RG218	PE4977	\$105.94	\$98.52	\$91.11	\$84.75	23
		RG58, RG55, RG141, RG142, RG400, RG223	PE4519	\$87.30	\$81.19	\$75.08	\$69.84	24

SC Connectors

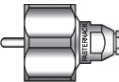
Product Image	Attachment Cable/Contact	Coax Type / Termination Type	Model No.	Price				Row
				1-24	25-49	50-99	100 +	
Male Right Angle, Cable Connectors								
	Clamp/Solder	RG213, RG214, RG8, RG9, RG393,	PE4979	\$116.88	\$108.70	\$100.52	\$93.50	1
		RG58, RG55, RG141, RG142, RG400, RG223	PE4978	\$99.76	\$92.78	\$85.79	\$79.81	2
Female Straight, Bulkhead Mount, Terminal								
	Solder	Wire Terminal, Hermetically Sealed, .250" Max Panel, B11 Mounting Hole	PE4980	\$28.93	\$26.90	\$24.88	\$23.14	3
Female Straight, Panel Mount, Terminal								
	Solder	4 Hole Flange, Solder Cup Contact, A13 Mounting Hole	PE4322	\$87.30	\$81.19	\$75.08	\$69.84	4

LC Connectors

Product Image	Attachment Cable/Contact	Coax Type / Termination Type	Model No.	Price				Row
				1-24	25-49	50-99	100 +	
Male Straight, Cable Connectors								
	Clamp/Solder	RG14, RG217	PE4563	\$129.60	\$120.53	\$111.46	\$103.68	5
		RG213, RG214, RG8, RG9, RG225, RG393	PE4564	\$114.65	\$106.62	\$98.60	\$91.72	6
		RG218, RG219	PE4323	\$153.01	\$142.30	\$131.59	\$122.41	7
		RG58, RG55, RG142, RG223, RG400	PE4565	\$137.25	\$127.64	\$118.04	\$109.80	8
Male Right Angle, Cable Connectors								
	Clamp/Solder	RG14, RG217	PE44448	\$180.82	\$168.16	\$155.51	\$144.66	9
		RG213, RG214, RG8, RG9, RG225, RG393	PE44447	\$174.64	\$162.42	\$150.19	\$139.71	10
		RG218	PE44449	\$189.18	\$175.94	\$162.69	\$151.34	11
Female Straight, Cable Connectors								
	Clamp/Solder	RG213, RG214, RG8, RG9, RG225, RG393	PE44450	\$156.30	\$145.36	\$134.42	\$125.04	12
		RG218	PE44451	\$178.54	\$166.04	\$153.54	\$142.83	13
Female Straight, Panel Mount, Terminal								
	Solder	4 Hole Flange, Pin, A12 Mounting Hole	PE4192	\$80.96	\$75.29	\$69.63	\$64.77	14

HN Connectors

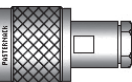
Product Image	Attachment Cable/Contact	Coax Type / Termination Type	Model No.	Price				Row
				1-24	25-49	50-99	100 +	
Male Straight, Cable Connectors								
	Crimp/Solder	RG213, RG8	PE4473	\$31.20	\$29.02	\$26.83	\$24.96	15
		RG214, RG9, RG225, RG393	PE4474	\$32.02	\$29.78	\$27.54	\$25.62	16
		RG58, RG141	PE4478	\$25.20	\$23.44	\$21.67	\$20.16	17
		RG55, RG142, RG223, RG400	PE4477	\$26.95	\$25.06	\$23.18	\$21.56	18
	Clamp/Solder	RG14, RG217	PE4475	\$32.58	\$30.30	\$28.02	\$26.06	19
		RG17, RG218	PE4476	\$94.64	\$88.02	\$81.39	\$75.71	20
		RG213, RG214, RG8, RG9, RG225, RG393	PE4182	\$18.67	\$17.36	\$16.06	\$14.94	21
		RG58, RG55, RG141, RG142, RG400, RG223	PE4198	\$25.84	\$24.03	\$22.22	\$20.67	22
		RG59, RG62	PE4479	\$36.51	\$33.95	\$31.40	\$29.21	23

Connectors



See Our Website For Real-Time Stock Availability!





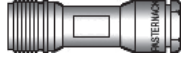
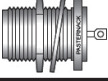

HN Connectors

Connectors

See Our Website For Real-Time Stock Availability!

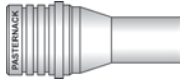
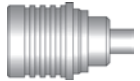
Product Image	Attachment Cable/Contact	Coax Type / Termination Type	Model No.	Price				Row
				1-24	25-49	50-99	100 +	
Male Right Angle, Cable Connectors								
	Clamp/Solder	RG14, RG217	PE44592	\$42.96	\$39.95	\$36.95	\$34.37	1
		RG213, RG214, RG8, RG9, RG225, RG393	PE4230	\$47.52	\$44.19	\$40.87	\$38.02	2
		RG58, RG55, RG141, RG142, RG400, RG223	PE4480	\$50.56	\$47.02	\$43.48	\$40.45	3
Female Straight, Cable Connectors								
	Clamp/Solder	RG213, RG214, RG8, RG9, RG225, RG393	PE4229	\$40.23	\$37.41	\$34.60	\$32.18	4
Female Straight, Bulkhead Mount, Terminal								
	Solder	Wire Terminal, Hermetically Sealed, Rear Mount, .300" Max Panel, G03 Mounting Hole	PE4481	\$44.58	\$41.46	\$38.34	\$35.66	5
Female Straight, Panel Mount, Terminal								
	Solder	4 Hole Flange, Solder Cup Contact, A08 Mounting Hole	PE4183	\$20.98	\$19.51	\$18.04	\$16.78	6

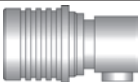
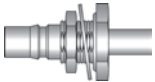
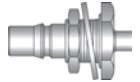
QMA Connectors

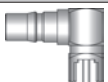
Product Image	Attachment Cable/Contact	Coax Type / Termination Type	Model No.	Price				Row
				1-24	25-49	50-99	100 +	
Male Straight, Cable Connectors								
	Crimp/Solder	RG316-DS, RG188-DS, 18 GHz	PE44502	\$15.00	\$13.95	\$12.90	\$12.00	7
		RG174, RG316, RG188, 18 GHz	PE44501	\$15.00	\$13.95	\$12.90	\$12.00	8
		RG58, RG141, 18 GHz	PE44503	\$14.08	\$13.09	\$12.11	\$11.26	9
	Solder/Solder	PE-SR402AL, PE-SR402FL, RG402, 18 GHz, .141" Semi-Rigid	PE44496	\$15.00	\$13.95	\$12.90	\$12.00	10
		PE-SR405AL, PE-SR405FL, RG405, 18 GHz, .085" Semi-Rigid	PE44495	\$15.00	\$13.95	\$12.90	\$12.00	11
Male Right Angle, Cable Connectors								
	Crimp/Solder	RG316-DS, RG188-DS, 18 GHz	PE44505	\$17.48	\$16.26	\$15.03	\$13.98	12
		RG174, RG316, RG188, 18 GHz	PE44504	\$17.48	\$16.26	\$15.03	\$13.98	13
		RG58, RG141, 18 GHz	PE44506	\$18.59	\$17.29	\$15.99	\$14.87	14
		RG55, RG142, RG223, RG400, 18 GHz	PE44515	\$21.75	\$20.23	\$18.71	\$17.40	15
	Solder/Solder	PE-SR402AL, PE-SR402FL, RG402, 18 GHz, .141" Semi-Rigid	PE44498	\$18.59	\$17.29	\$15.99	\$14.87	16
		PE-SR405AL, PE-SR405FL, RG405, 18 GHz, .085" Semi-Rigid	PE44497	\$18.59	\$17.29	\$15.99	\$14.87	17
Female Straight, Bulkhead Mount, Cable Connectors								
	Crimp/Solder	RG316-DS, RG188-DS, B17 Mounting Hole, 18 GHz	PE44508	\$15.00	\$13.95	\$12.90	\$12.00	18
		RG174, RG316, RG188, B17 Mounting Hole, 18 GHz	PE44507	\$15.00	\$13.95	\$12.90	\$12.00	19
		RG58, RG141, B17 Mounting Hole, 18 GHz	PE44509	\$15.00	\$13.95	\$12.90	\$12.00	20
	Solder/Solder	PE-SR402AL, PE-SR402FL, RG402, B17 Mounting Hole, 18 GHz, .141" Semi-Rigid	PE44500	\$17.48	\$16.26	\$15.03	\$13.98	21
		PE-SR405AL, PE-SR405FL, RG405, B17 Mounting Hole, 18 GHz, .085" Semi-Rigid	PE44499	\$17.48	\$16.26	\$15.03	\$13.98	22
Female Straight, PCB Mount								
	Solder	Surface Mount, 18 GHz	PE44510	\$41.14	\$38.26	\$35.38	\$32.91	23
		Thru Hole, 18 GHz	PE44512	\$9.88	\$9.19	\$8.50	\$7.90	24
Female Right Angle, PCB Mount								
	Solder	Surface Mount, 18 GHz	PE44511	\$24.88	\$23.14	\$21.40	\$19.90	25
		Thru Hole, 18 GHz	PE44513	\$18.59	\$17.29	\$15.99	\$14.87	26

QN Connectors

Product Image	Attachment Cable/Contact	Coax Type / Termination Type	Model No.	Price				Row
				1-24	25-49	50-99	100 +	
Male Straight, Cable Connectors								
	Crimp/Solder	RG213, RG215, RG8, 11 GHz	PE44597	\$34.05	\$31.67	\$29.28	\$27.24	1
		RG214, RG225, RG9, RG393, 11 GHz	PE44598	\$33.39	\$31.05	\$28.72	\$26.71	2
		RG58, RG141, RG303, 11 GHz	PE44596	\$23.81	\$22.14	\$20.48	\$19.05	3
		RG55, RG142, RG223, RG400, 11 GHz	PE44595	\$26.19	\$24.36	\$22.52	\$20.95	4
	Solder/Solder	PE-SR402AL, PE-SR402FL, RG402, 11 GHz, .141" Semi-Rigid	PE44599	\$29.79	\$27.70	\$25.62	\$23.83	5
Male Right Angle, Cable Connectors								
	Crimp/Solder	RG213, RG215, RG8, 11 GHz	PE44602	\$39.32	\$36.57	\$33.82	\$31.46	6
		RG214, RG225, RG9, RG393, 11 GHz	PE44603	\$39.32	\$36.57	\$33.82	\$31.46	7
		RG58, RG141, RG303, 11 GHz	PE44601	\$29.79	\$27.70	\$25.62	\$23.83	8
		RG55, RG142, RG223, RG400, 11 GHz	PE44600	\$29.79	\$27.70	\$25.62	\$23.83	9
	Solder/Solder	PE-SR402AL, PE-SR402FL, RG402, 11 GHz, .141" Semi-Rigid	PE44604	\$39.32	\$36.57	\$33.82	\$31.46	10
Female Straight, Bulkhead Mount, Cable Connectors								
	Crimp/Solder	RG213, RG215, RG8, F02 Mounting Hole, 11 GHz	PE44607	\$36.93	\$34.34	\$31.76	\$29.54	11
		RG214, RG225, RG9, RG393, F02 Mounting Hole, 11 GHz	PE44608	\$36.93	\$34.34	\$31.76	\$29.54	12
		RG58, RG141, RG303, F02 Mounting Hole, 11 GHz	PE44606	\$27.92	\$25.97	\$24.01	\$22.34	13
		RG55, RG142, RG223, RG400, F02 Mounting Hole, 11 GHz	PE44605	\$27.36	\$25.44	\$23.53	\$21.89	14
	Solder/Solder	PE-SR402AL, PE-SR402FL, RG402, F02 Mounting Hole, 11 GHz, .141" Semi-Rigid	PE44609	\$36.93	\$34.34	\$31.76	\$29.54	15
Female Straight, Panel Mount, Terminal								
	Solder	4 Hole Flange, Solder Cup Contact, 11 GHz, D16 Mounting Hole	PE44610	\$54.87	\$51.03	\$47.19	\$43.90	16

SMP Connectors

Product Image	Attachment Cable/Contact	Coax Type / Termination Type	Model No.	Price				Row
				1-24	25-49	50-99	100 +	
Male Straight, Bulkhead Mount, Cable Connectors								
	Solder/Solder	PE-SR405AL, PE-SR405FL, RG405, Rear Mount, F11 Mounting Hole, .085" Semi-Rigid	PE44483	\$29.89	\$27.80	\$25.71	\$23.91	17
Female Straight, Cable Connectors								
	Solder/Solder	PE-047SR, PE-SR047AL, PE-SR047FL, .047" Semi-Rigid	PE44273	\$22.44	\$20.87	\$19.30	\$17.95	18
		PE-SR405AL, PE-SR405FL, RG405, .085" Semi-Rigid	PE44272	\$27.71	\$25.77	\$23.83	\$22.17	19
		RG178, RG196	PE44655	\$37.54	\$34.91	\$32.28	\$30.03	20
Female Right Angle, Cable Connectors								
	Solder/Solder	PE-047SR, PE-SR047AL, PE-SR047FL, .047" Semi-Rigid	PE44274	\$29.79	\$27.70	\$25.62	\$23.83	21
		PE-SR405AL, PE-SR405FL, RG405, .085" Semi-Rigid	PE44275	\$23.15	\$21.53	\$19.91	\$18.52	22
Male Straight, PCB Mount								
	Solder	Surface Mount, End Launch	PE44482	\$18.75	\$17.44	\$16.13	\$15.00	23
		Surface Mount	PE44481	\$25.89	\$24.08	\$22.27	\$20.71	24
		Thru Hole	PE44480	\$24.67	\$22.94	\$21.22	\$19.74	25
		Thru Hole, D03 Mounting Hole	PE44348	\$23.51	\$21.86	\$20.22	\$18.81	26

Connectors

See Our Website For Real-Time Stock Availability!

MINI SMP Connectors

Product Image	Attachment Cable/Contact	Coax Type / Termination Type	Model No.	Price				Row
				1-24	25-49	50-99	100 +	
Female Straight, Cable Connectors								
	Solder	PE-047SR, PE-SR047AL, PE-SR047FL, 65 GHz, .047" Semi-Rigid	PE44491	\$27.36	\$25.44	\$23.53	\$21.89	1
		PE-SR405AL, PE-SR405FL, RG405, 65 GHz, .085" Semi-Rigid	PE44492	\$27.00	\$25.11	\$23.22	\$21.60	2
Female Right Angle, Cable Connectors								
	Solder	PE-047SR, PE-SR047AL, PE-SR047FL, 65 GHz, .047" Semi-Rigid	PE44493	\$31.11	\$28.93	\$26.75	\$24.89	3
		PE-SR405AL, PE-SR405FL, RG405, 65 GHz, .085" Semi-Rigid	PE44494	\$31.67	\$29.45	\$27.24	\$25.34	4
Male Straight, PCB Mount								
	Solder	Surface Mount, End Launch, 65 GHz	PE44490	\$18.75	\$17.44	\$16.13	\$15.00	5
		Surface Mount, 65 GHz	PE44489	\$25.89	\$24.08	\$22.27	\$20.71	6

UMCX Connectors

Product Image	Attachment Cable/Contact	Coax Type / Termination Type	Model No.	Price				Row
				1-24	25-49	50-99	100 +	
Jack Straight, PCB Mount								
	Solder	Surface Mount, 6 GHz	PE44594	\$1.11	\$1.03	\$0.95	\$0.89	7



MMCX Connectors

Product Image	Attachment Cable/Contact	Coax Type / Termination Type	Model No.	Price				Row
				1-24	25-49	50-99	100 +	
Plug Straight, Cable Connectors								
	Crimp/Solder	RG174, RG316, RG188	PE4896	\$12.16	\$11.31	\$10.46	\$9.73	8
		RG178, RG196	PE4897	\$11.86	\$11.03	\$10.20	\$9.49	9
		RG178, RG196, Easy Grip	PE44645	\$11.65	\$10.83	\$10.02	\$9.32	10
	Solder	PE-047SR, PE-SR047AL, PE-SR047FL, .047" Semi-Rigid	PE44456	\$16.16	\$15.03	\$13.90	\$12.93	11
		PE-SR405AL, PE-SR405FL, RG405, .085" Semi-Rigid	PE44453	\$12.97	\$12.06	\$11.15	\$10.38	12
Plug Right Angle, Cable Connectors								
	Crimp/Solder	RG174, RG316, RG188	PE4898	\$15.20	\$14.14	\$13.07	\$12.16	13
		RG178, RG196	PE4899	\$13.22	\$12.29	\$11.37	\$10.58	14
	Solder	PE-047SR, PE-SR047AL, PE-SR047FL, .047" Semi-Rigid	PE44457	\$17.18	\$15.98	\$14.77	\$13.74	15
		PE-SR405AL, PE-SR405FL, RG405, .085" Semi-Rigid	PE4900	\$13.22	\$12.29	\$11.37	\$10.58	16
Jack Straight, Cable Connectors								
	Crimp/Solder	RG174, RG316, RG188	PE4901	\$12.21	\$11.36	\$10.50	\$9.77	17
		RG178, RG196	PE4902	\$12.21	\$11.36	\$10.50	\$9.77	18
	Solder	PE-047SR, PE-SR047AL, PE-SR047FL, .047" Semi-Rigid	PE44459	\$22.34	\$20.78	\$19.21	\$17.87	19
		PE-SR405AL, PE-SR405FL, RG405, .085" Semi-Rigid	PE44458	\$16.16	\$15.03	\$13.90	\$12.93	20
Plug Straight, PCB Mount								
	Solder	Surface Mount, End Launch, Switching Connector	PE44663	\$15.05	\$14.00	\$12.94	\$12.04	21
		Surface Mount, Switching Connector	PE44662	\$15.05	\$14.00	\$12.94	\$12.04	22
		.028" Dia. Contact, .115" Leg Length, Thru Hole, D03 Mounting Hole	PE4905	\$21.13	\$19.65	\$18.17	\$16.90	23







Connectors

See Our Website For Real-Time Stock Availability!

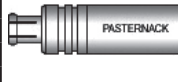
MMCX Connectors

Product Image	Attachment Cable/Contact	Coax Type / Termination Type	Model No.	Price				Row
				1-24	25-49	50-99	100 +	
Jack Straight, PCB Mount								
	Solder	.028" Dia. Contact, .115" Leg Length, Thru Hole, D03 Mounting Hole	PE4904	\$9.73	\$9.05	\$8.37	\$7.78	1
Jack Right Angle, PCB Mount								
	Solder	.028" Dia. Contact, .115" Leg Length, Thru Hole, D03 Mounting Hole	PE4903	\$18.44	\$17.15	\$15.86	\$14.75	2

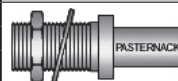
MCX Connectors

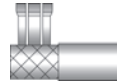
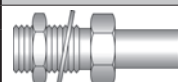
Product Image	Attachment Cable/Contact	Coax Type / Termination Type	Model No.	Price				Row
				1-24	25-49	50-99	100 +	
Plug Straight, Cable Connectors								
	Crimp/Solder	RG188-DS, RG316-DS	PE4878	\$9.60	\$8.93	\$8.26	\$7.68	3
		RG178, RG196	PE4552	\$12.72	\$11.83	\$10.94	\$10.18	4
		RG316, RG174, RG188	PE4551	\$9.73	\$9.05	\$8.37	\$7.78	5
		RG58	PE4880	\$14.75	\$13.72	\$12.69	\$11.80	6
		RG55, RG142, RG223, RG400	PE4881	\$20.27	\$18.85	\$17.43	\$16.22	7
	Solder	PE-SR405AL, PE-SR405FL, RG405, .085" Semi-Rigid	PE4876	\$17.28	\$16.07	\$14.86	\$13.82	8
Plug Right Angle, Cable Connectors								
	Crimp/Solder	RG188-DS, RG316-DS	PE4879	\$11.90	\$11.07	\$10.23	\$9.52	9
		RG174, RG316, RG188	PE4553	\$12.16	\$11.31	\$10.46	\$9.73	10
		RG178, RG196	PE4554	\$12.21	\$11.36	\$10.50	\$9.77	11
		RG58	PE4882	\$14.24	\$13.24	\$12.25	\$11.39	12
		RG55, RG142, RG223, RG400	PE4883	\$13.15	\$12.23	\$11.31	\$10.52	13
	Solder	PE-SR405AL, PE-SR405FL, RG405, .085" Semi-Rigid	PE4877	\$18.59	\$17.29	\$15.99	\$14.87	14
Jack Straight, Cable Connectors								
	Crimp/Solder	RG188-DS, RG316-DS	PE4885	\$12.50	\$11.63	\$10.75	\$10.00	15
		RG174, RG316, RG188	PE4562	\$16.00	\$14.88	\$13.76	\$12.80	16
		RG178, RG196	PE4884	\$14.29	\$13.29	\$12.29	\$11.43	17
Jack Straight, Bulkhead Mount, Cable Connectors								
	Crimp/Solder	RG188-DS, RG316-DS, B01 Mounting Hole	PE4888	\$13.15	\$12.23	\$11.31	\$10.52	18
		RG174, RG316, RG188, B01 Mounting Hole	PE4887	\$14.74	\$13.71	\$12.68	\$11.79	19
		RG178, RG196, B01 Mounting Hole	PE4886	\$24.49	\$22.78	\$21.06	\$19.59	20
Reverse Polarity Plug Straight, Cable Connectors								
	Crimp/Solder	RG174, RG316, RG188	PE44369	\$18.59	\$17.29	\$15.99	\$14.87	21
		RG178, RG196	PE44370	\$18.59	\$17.29	\$15.99	\$14.87	22
Reverse Polarity Plug Right Angle, Cable Connectors								
	Crimp/Solder	RG174, RG316, RG188	PE44371	\$21.13	\$19.65	\$18.17	\$16.90	23
		RG178, RG196	PE44372	\$21.13	\$19.65	\$18.17	\$16.90	24
Reverse Polarity Jack Straight, Bulkhead Mount, Cable Connectors								
	Crimp/Solder	RG174, RG316, RG188, B01 Mounting Hole	PE44373	\$23.66	\$22.00	\$20.35	\$18.93	25
		RG178, RG196, B01 Mounting Hole	PE44374	\$23.66	\$22.00	\$20.35	\$18.93	26

Connectors









See Our Website For Real-Time Stock Availability!

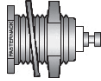
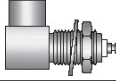

MCX Connectors

Connectors







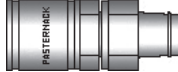

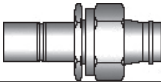

See Our Website For Real-Time Stock Availability!

Product Image	Attachment Cable/Contact	Coax Type / Termination Type	Model No.	Price				Row
				1-24	25-49	50-99	100 +	
Jack Straight, Bulkhead Mount, Terminal								
	Solder	Turret, .118" Max Panel, B01 Mounting Hole	PE4561	\$12.21	\$11.36	\$10.50	\$9.77	1
Jack Right Angle, Bulkhead Mount, Terminal								
	Solder	Turret, .118" Max Panel, B01 Mounting Hole	PE4560	\$29.94	\$27.84	\$25.75	\$23.95	2
Jack Straight, Panel Mount, Terminal								
	Solder	2 Hole Flange, .038" Dia. Contact, .200" Extended Dielectric, C03 Mounting Hole	PE4894	\$13.68	\$12.72	\$11.76	\$10.94	3
		2 Hole Flange, Solder Cup Contact, C03 Mounting Hole	PE4891	\$15.05	\$14.00	\$12.94	\$12.04	4
		4 Hole Flange, Solder Cup Contact, A17 Mounting Hole	PE4895	\$24.88	\$23.14	\$21.40	\$19.90	5
Plug Straight, PCB Mount								
	Solder	Surface Mount, End Launch, Switching Connector	PE44661	\$15.05	\$14.00	\$12.94	\$12.04	6
		Surface Mount, Switching Connector	PE44660	\$15.05	\$14.00	\$12.94	\$12.04	7
		Surface Mount	PE44613	\$10.74	\$9.99	\$9.24	\$8.59	8
		.036" Dia. Contact, .155" Leg Length, Thru Hole, D04 Mounting Hole	PE4559	\$14.03	\$13.05	\$12.07	\$11.22	9
Jack Straight, PCB Mount								
	Solder	.042 End Launch, .019" Round Contact, .125" Leg Length	PE4893	\$13.68	\$12.72	\$11.76	\$10.94	10
		.062" End Launch, .019" Round Contact, .125" Leg Length	PE4892	\$17.58	\$16.35	\$15.12	\$14.06	11
		Surface Mount	PE4889	\$10.34	\$9.62	\$8.89	\$8.27	12
		.038" Dia. Contact, .155" Leg Length, Thru Hole, D04 Mounting Hole	PE4555	\$8.51	\$7.91	\$7.32	\$6.81	13
Jack Right Angle, PCB Mount								
	Solder	Surface Mount	PE4890	\$17.28	\$16.07	\$14.86	\$13.82	14
		.036" Dia. Contact, .155" Leg Length, Thru Hole, D04 Mounting Hole	PE4556	\$11.10	\$10.32	\$9.55	\$8.88	15
Reverse Polarity Jack Straight, PCB Mount								
	Solder	.038" Dia. Contact, .155" Leg Length, Thru Hole, D02 Mounting Hole	PE44375	\$11.20	\$10.42	\$9.63	\$8.96	16
Reverse Polarity Jack Straight, Bulkhead Mount, PCB Mount								
	Solder	Surface Mount, End Launch, .019" Dia. Contact, .125" Leg Length, B01 Mounting Hole	PE44377	\$18.59	\$17.29	\$15.99	\$14.87	17
Reverse Polarity Jack Right Angle, Bulkhead Mount, PCB Mount								
	Solder	.038" Dia. Contact, .155" Leg Length, Thru Hole, D02 & B01 Mounting Hole	PE44376	\$24.88	\$23.14	\$21.40	\$19.90	18

SMB Connectors (These Connectors will not mate to Standard 75 Ohm SMB Connectors)

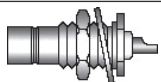
Product Image	Attachment Cable/Contact	Coax Type / Termination Type	Model No.	Price				Row
				1-24	25-49	50-99	100 +	
Plug Straight, Cable Connectors								
	Crimp/Solder	RG174, RG316, RG188	PE4046	\$9.12	\$8.48	\$7.84	\$7.30	19
		RG178, RG196	PE4080	\$12.59	\$11.71	\$10.83	\$10.07	20
		RG58	PE4523	\$13.58	\$12.63	\$11.68	\$10.86	21
		RG55, RG142, RG223, RG400	PE4593	\$13.15	\$12.23	\$11.31	\$10.52	22
	Clamp/Solder	PE-SR405AL, PE-SR405FL, RG405, .085" Semi-Rigid	PE4356	\$10.80	\$10.04	\$9.29	\$8.64	23
		RG174, RG316, RG188	PE4200	\$11.91	\$11.08	\$10.24	\$9.53	24
		RG178, RG196	PE4250	\$15.30	\$14.23	\$13.16	\$12.24	25

SMB Connectors (These Connectors will not mate to Standard 75 Ohm SMB Connectors)

Product Image	Attachment Cable/Contact	Coax Type / Termination Type	Model No.	Price				Row
				1-24	25-49	50-99	100 +	
Plug Right Angle, Cable Connectors								
	Crimp/Solder	RG174, RG316, RG188	PE4052	\$12.26	\$11.40	\$10.54	\$9.81	1
		RG178, RG196	PE4159	\$12.21	\$11.36	\$10.50	\$9.77	2
		RG58	PE4522	\$15.96	\$14.84	\$13.73	\$12.77	3
		RG55, RG142, RG223, RG400	PE4595	\$15.60	\$14.51	\$13.42	\$12.48	4
	Clamp/Solder	PE-SR405AL, PE-SR405FL, RG405, .085" Semi-Rigid	PE4358	\$12.85	\$11.95	\$11.05	\$10.28	5
		RG174, RG316, RG188	PE4260	\$32.37	\$30.10	\$27.84	\$25.90	6
		RG178, RG196	PE4261	\$32.37	\$30.10	\$27.84	\$25.90	7
Jack Straight, Cable Connectors								
	Crimp/Solder	RG174, RG316, RG188	PE4096	\$10.28	\$9.56	\$8.84	\$8.22	8
		RG178, RG196	PE4926	\$18.75	\$17.44	\$16.13	\$15.00	9
	Clamp/Solder	PE-SR405AL, PE-SR405FL, RG405, .085" Semi-Rigid	PE4360	\$13.40	\$12.46	\$11.52	\$10.72	10
		RG174, RG316, RG188	PE4268	\$11.86	\$11.03	\$10.20	\$9.49	11
		RG178, RG196	PE4269	\$17.63	\$16.40	\$15.16	\$14.10	12
Jack Straight, Bulkhead Mount, Cable Connectors								
	Crimp/Solder	RG174, RG316, RG188, B01 Mounting Hole	PE4097	\$11.70	\$10.88	\$10.06	\$9.36	13
		RG178, RG196, B01 Mounting Hole	PE4364	\$11.30	\$10.51	\$9.72	\$9.04	14
		RG58, B01 Mounting Hole	PE44094	\$21.25	\$19.76	\$18.28	\$17.00	15
		RG55, RG142, RG223, RG400, B01 Mounting Hole	PE44048	\$23.51	\$21.86	\$20.22	\$18.81	16
	Clamp/Solder	PE-SR405AL, PE-SR405FL, RG405, B01 Mounting Hole, .085" Semi-Rigid	PE4362	\$13.43	\$12.49	\$11.55	\$10.74	17
		RG174, RG316, RG188, B01 Mounting Hole	PE4276	\$12.41	\$11.54	\$10.67	\$9.93	18
		RG178, RG196, B01 Mounting Hole	PE4277	\$12.41	\$11.54	\$10.67	\$9.93	19
Plug Straight, Bulkhead Mount, Terminal								
	Solder	Solder Cup Contact, Front Mount, .180" Max Panel, B01 Mounting Hole	PE4288	\$11.96	\$11.12	\$10.29	\$9.57	20
Jack Straight, Bulkhead Mount, Terminal								
	Solder	Solder Cup Contact, Front Mount, B01 Mounting Hole	PE4170	\$10.59	\$9.85	\$9.11	\$8.47	21
		Solder Cup Contact, Rear Mount, B01 Mounting Hole	PE4167	\$5.19	\$4.83	\$4.46	\$4.15	22
Jack Right Angle, Bulkhead Mount, Terminal								
	Solder	Solder Cup Contact, Front Mount, .093" Max Panel, B01 Mounting Hole	PE4284	\$24.02	\$22.34	\$20.66	\$19.22	23
Jack Straight, Panel Mount, Terminal								
	Solder	2 Hole Flange, Solder Cup Contact, C07 Mounting Hole	PE44139	\$18.59	\$17.29	\$15.99	\$14.87	24
		4 Hole Flange, Solder Cup Contact, A22 Mounting Hole	PE44142	\$18.59	\$17.29	\$15.99	\$14.87	25
Plug Straight, PCB Mount								
	Solder	.038" Dia. Contact, .155" Leg Length, Thru Hole, D02 Mounting Hole	PE4366	\$14.39	\$13.38	\$12.38	\$11.51	26
Plug Right Angle, PCB Mount								
	Solder	.037" Dia. Contact, .155" Leg Length, Thru Hole, D02 Mounting Hole	PE4245	\$14.34	\$13.34	\$12.33	\$11.47	27

Connectors

See Our Website For Real-Time Stock Availability!



SMB Connectors (These Connectors will not mate to Standard 75 Ohm SMB Connectors)

Connectors



Product Image	Attachment Cable/Contact	Coax Type / Termination Type	Model No.	Price				Row
				1-24	25-49	50-99	100 +	
Jack Straight, PCB Mount								
	Solder	.042" End Launch, .030" Round Contact, .187" Leg Length	PE44132	\$17.63	\$16.40	\$15.16	\$14.10	1
		.042" End Launch, .020" x .010" Tab Contact, .187" Leg Length	PE44137	\$16.72	\$15.55	\$14.38	\$13.38	2
		.062" End Launch, .020" x .010" Tab Contact, .187" Leg Length	PE44135	\$17.47	\$16.25	\$15.02	\$13.98	3
		.062" End Launch, .030" Dia Contact, .187" Leg Length	PE44129	\$15.05	\$14.00	\$12.94	\$12.04	4
		Surface Mount	PE44119	\$6.43	\$5.98	\$5.53	\$5.14	5
Jack Right Angle, PCB Mount								
	Solder	Surface Mount	PE44121	\$15.45	\$14.37	\$13.29	\$12.36	6
Jack Straight, PCB Mount								
	Solder	.037" Dia. Contact, .155" Leg Length, Thru Hole, D02 Mounting Hole	PE4174	\$5.14	\$4.78	\$4.42	\$4.11	7
Jack Right Angle, PCB Mount								
	Solder	.038" Dia. Contact, .155" Leg Length, Thru Hole, D02 Mounting Hole	PE4177	\$8.61	\$8.01	\$7.40	\$6.89	8
Jack Straight, Bulkhead Mount, PCB Mount								
	Solder	.038" Dia. Contact, .155" Leg Length, Thru Hole, .093" Max Panel, B01 & D02 Mounting Hole	PE44123	\$13.83	\$12.86	\$11.89	\$11.06	9
Jack Right Angle, Bulkhead Mount, PCB Mount								
	Solder	.038" Dia. Contact, .155" Leg Length, .093" Max Panel, Thru Hole, B01 & D02 Mounting Hole	PE44126	\$15.81	\$14.70	\$13.60	\$12.65	10

SSMB Connectors



Product Image	Attachment Cable/Contact	Coax Type / Termination Type	Model No.	Price				Row
				1-24	25-49	50-99	100 +	
Plug Straight, Cable Connectors								
	Crimp/Solder	RG174, RG179, RG316, RG188	PE4017	\$22.09	\$20.54	\$19.00	\$17.67	11
		RG178, RG196	PE4019	\$20.27	\$18.85	\$17.43	\$16.22	12
Plug Right Angle, Cable Connectors								
	Crimp/Solder	RG174, RG316, RG188	PE4334	\$19.96	\$18.56	\$17.17	\$15.97	13
		RG178, RG196	PE4335	\$14.24	\$13.24	\$12.25	\$11.39	14
Jack Straight, Bulkhead Mount, Cable Connectors								
	Crimp/Solder	RG174, RG316, RG188, B10 Mounting Hole	PE4336	\$24.88	\$23.14	\$21.40	\$19.90	15
		RG178, RG196, B10 Mounting Hole	PE4337	\$24.88	\$23.14	\$21.40	\$19.90	16
Jack Straight, Bulkhead Mount, Terminal								
	Solder	Turret, Rear Mount, B10 Mounting Hole	PE4338	\$18.59	\$17.29	\$15.99	\$14.87	17
		Turret, Front Mount, B10 Mounting Hole	PE4339	\$19.30	\$17.95	\$16.60	\$15.44	18
Jack Straight, Panel Mount, Terminal								
	Solder	4 Hole Flange, Tab, .005" X .028" Tab Contact, D15 Mounting Hole	PE44455	\$18.75	\$17.44	\$16.13	\$15.00	19

See Our Website For Real-Time Stock Availability!

SSMB Connectors

Product Image	Attachment Cable/Contact	Coax Type / Termination Type	Model No.	Price				Row
				1-24	25-49	50-99	100 +	
Jack Straight, PCB Mount								
	Solder	.025" Dia. Contact, .155" Leg Length, Thru Hole, D03 Mounting Hole	PE4340	\$9.73	\$9.05	\$8.37	\$7.78	1
Jack Right Angle, PCB Mount								
	Solder	.025" Dia. Contact, .155" Leg Length, Thru Hole, D03 Mounting Hole	PE4341	\$15.30	\$14.23	\$13.16	\$12.24	2

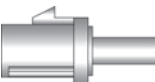
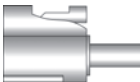
FAKRA Connectors

Product Image	Attachment Cable/Contact	Coax Type / Termination Type	Model No.	Price				Row
				1-24	25-49	50-99	100 +	
Plug Straight, Cable Connectors								
	Crimp/Solder	PE-C100, RG174, RG316, Black Color, Radio with Phantom Supply	PE44647A	\$4.26	\$3.96	\$3.66	\$3.41	3
		PE-C100, RG174, RG316, White Color, Radio without Phantom Supply	PE44647B	\$4.26	\$3.96	\$3.66	\$3.41	4
		PE-C100, RG174, RG316, Blue Color, GPS: Telematics or Navigation	PE44647C	\$4.26	\$3.96	\$3.66	\$3.41	5
		PE-C100, RG174, RG316, Bordeaux Color, GSM: Cellular Phone	PE44647D	\$4.26	\$3.96	\$3.66	\$3.41	6
		PE-C100, RG174, RG316, Violet Color, GPS: Telematics and Navigation	PE44647H	\$4.26	\$3.96	\$3.66	\$3.41	7
		PE-C100, RG174, RG316, Beige Color, Bluetooth	PE44647I	\$4.26	\$3.96	\$3.66	\$3.41	8
		PE-C100, RG174, RG316, Curry Color, Radio with I.F. Output (Antenna Diversity)	PE44647K	\$4.26	\$3.96	\$3.66	\$3.41	9
PE-C100, RG174, RG316, Water Blue Color, Neutral Coding	PE44647Z	\$4.26	\$3.96	\$3.66	\$3.41	10		
Jack Straight, Cable Connectors								
	Crimp/Solder	PE-C100, RG174, RG316, Black Color, Radio with Phantom Supply	PE44646A	\$4.26	\$3.96	\$3.66	\$3.41	11
		PE-C100, RG174, RG316, White Color, Radio without Phantom Supply	PE44646B	\$4.26	\$3.96	\$3.66	\$3.41	12
		PE-C100, RG174, RG316, Blue Color, GPS: Telematics or Navigation	PE44646C	\$4.26	\$3.96	\$3.66	\$3.41	13
		PE-C100, RG174, RG316, Bordeaux Color, GSM: Cellular Phone	PE44646D	\$4.26	\$3.96	\$3.66	\$3.41	14
		PE-C100, RG174, RG316, Violet Color, GPS: Telematics and Navigation	PE44646H	\$4.26	\$3.96	\$3.66	\$3.41	15
		PE-C100, RG174, RG316, Beige Color, Bluetooth	PE44646I	\$4.26	\$3.96	\$3.66	\$3.41	16
		PE-C100, RG174, RG316, Curry Color, Radio with I.F. Output (Antenna Diversity)	PE44646K	\$4.26	\$3.96	\$3.66	\$3.41	17
PE-C100, RG174, RG316, Water Blue Color, Neutral Coding	PE44646Z	\$4.26	\$3.96	\$3.66	\$3.41	18		
Jack Right Angle, Cable Connectors								
	Crimp/Solder	PE-C100, RG174, RG316, Black Color, Radio with Phantom Supply	PE44648A	\$5.32	\$4.95	\$4.58	\$4.26	19
		PE-C100, RG174, RG316, White Color, Radio without Phantom Supply	PE44648B	\$5.32	\$4.95	\$4.58	\$4.26	20
		PE-C100, RG174, RG316, Blue Color, GPS: Telematics or Navigation	PE44648C	\$5.32	\$4.95	\$4.58	\$4.26	21
		PE-C100, RG174, RG316, Bordeaux Color, GSM: Cellular Phone	PE44648D	\$5.32	\$4.95	\$4.58	\$4.26	22
		PE-C100, RG174, RG316, Violet Color, GPS: Telematics and Navigation	PE44648H	\$5.32	\$4.95	\$4.58	\$4.26	23
		PE-C100, RG174, RG316, Beige Color, Bluetooth	PE44648I	\$5.32	\$4.95	\$4.58	\$4.26	24
		PE-C100, RG174, RG316, Curry Color, Radio with I.F. Output (Antenna Diversity)	PE44648K	\$5.32	\$4.95	\$4.58	\$4.26	25
PE-C100, RG174, RG316, Water Blue Color, Neutral Coding	PE44648Z	\$5.32	\$4.95	\$4.58	\$4.26	26		
Plug Straight, PCB Mount								
	Solder	.039" Dia. Contact, .155" Leg Length, Thru Hole, Black Color, Radio with Phantom Supply, D02 Mounting Hole	PE44649A	\$4.26	\$3.96	\$3.66	\$3.41	27
		.039" Dia. Contact, .155" Leg Length, Thru Hole, White Color, Radio without Phantom Supply, D02 Mounting Hole	PE44649B	\$4.26	\$3.96	\$3.66	\$3.41	28
		.039" Dia. Contact, .155" Leg Length, Thru Hole, Blue Color, GPS: Telematics or Navigation, D02 Mounting Hole	PE44649C	\$4.26	\$3.96	\$3.66	\$3.41	29
		.039" Dia. Contact, .155" Leg Length, Thru Hole, Bordeaux Color, GSM: Cellular Phone, D02 Mounting Hole	PE44649D	\$4.26	\$3.96	\$3.66	\$3.41	30
		.039" Dia. Contact, .155" Leg Length, Thru Hole, D02 Mounting Hole, Violet Color, GPS: Telematics and Navigation	PE44649H	\$4.26	\$3.96	\$3.66	\$3.41	31
		.039" Dia. Contact, .155" Leg Length, Thru Hole, Beige Color, Bluetooth, D02 Mounting Hole	PE44649I	\$4.26	\$3.96	\$3.66	\$3.41	32
		.039" Dia. Contact, .155" Leg Length, Thru Hole, Curry Color, Radio with I.F. Output (Antenna Diversity), D02 Mounting Hole	PE44649K	\$4.26	\$3.96	\$3.66	\$3.41	33
		.039" Dia. Contact, .155" Leg Length, Thru Hole, D02 Mounting Hole, Water Blue Color, Neutral Coding	PE44649Z	\$4.26	\$3.96	\$3.66	\$3.41	34

Connectors

See Our Website For Real-Time Stock Availability!



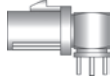

FAKRA Connectors

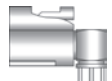
Connectors

Product Image	Attachment Cable/Contact	Coax Type / Termination Type	Model No.	Price				Row
				1-24	25-49	50-99	100 +	
Plug Right Angle, PCB Mount								
	Solder	.036" Dia. Contact, .138" Leg Length, Thru Hole, Black Color, Radio with Phantom Supply, D07 Mounting Hole	PE44651A	\$5.32	\$4.95	\$4.58	\$4.26	1
		.036" Dia. Contact, .138" Leg Length, Thru Hole, White Color, Radio without Phantom Supply, D07 Mounting Hole	PE44651B	\$5.32	\$4.95	\$4.58	\$4.26	2
		.036" Dia. Contact, .138" Leg Length, Thru Hole, Blue Color, GPS: Telematics or Navigation, D07 Mounting Hole	PE44651C	\$5.32	\$4.95	\$4.58	\$4.26	3
		.036" Dia. Contact, .138" Leg Length, Thru Hole, Bordeaux Color, GSM: Cellular Phone, D07 Mounting Hole	PE44651D	\$5.32	\$4.95	\$4.58	\$4.26	4
		.036" Dia. Contact, .138" Leg Length, Thru Hole, D07 Mounting Hole, Violet Color, GPS: Telematics and Navigation	PE44651H	\$5.32	\$4.95	\$4.58	\$4.26	5
		.036" Dia. Contact, .138" Leg Length, Thru Hole, Beige Color, Bluetooth, D07 Mounting Hole	PE44651I	\$5.32	\$4.95	\$4.58	\$4.26	6
		.036" Dia. Contact, .138" Leg Length, Thru Hole, Curry Color, Radio with I.F. Output (Antenna Diversity), D07 Mounting Hole	PE44651K	\$5.32	\$4.95	\$4.58	\$4.26	7
		.036" Dia. Contact, .138" Leg Length, Thru Hole, Water Blue Color, Neutral Coding, D07 Mounting Hole	PE44651Z	\$5.32	\$4.95	\$4.58	\$4.26	8

Jack Right Angle, PCB Mount								
	Solder	.036" Dia. Contact, .138" Leg Length, Thru Hole, Black Color, Radio with Phantom Supply, D07 Mounting Hole	PE44650A	\$5.88	\$5.47	\$5.06	\$4.70	9
		.036" Dia. Contact, .138" Leg Length, Thru Hole, White Color, Radio without Phantom Supply, D07 Mounting Hole	PE44650B	\$5.88	\$5.47	\$5.06	\$4.70	10
		.036" Dia. Contact, .138" Leg Length, Thru Hole, Blue Color, GPS: Telematics or Navigation, D07 Mounting Hole	PE44650C	\$5.88	\$5.47	\$5.06	\$4.70	11
		.036" Dia. Contact, .138" Leg Length, Thru Hole, Bordeaux Color, GSM: Cellular Phone, D07 Mounting Hole	PE44650D	\$5.88	\$5.47	\$5.06	\$4.70	12
		.036" Dia. Contact, .138" Leg Length, Thru Hole, D07 Mounting Hole, Violet Color, GPS: Telematics and Navigation	PE44650H	\$5.88	\$5.47	\$5.06	\$4.70	13
		.036" Dia. Contact, .138" Leg Length, Thru Hole, Beige Color, Bluetooth, D07 Mounting Hole	PE44650I	\$5.88	\$5.47	\$5.06	\$4.70	14
		.036" Dia. Contact, .138" Leg Length, Thru Hole, Curry Color, Radio with I.F. Output (Antenna Diversity), D07 Mounting Hole	PE44650K	\$5.88	\$5.47	\$5.06	\$4.70	15
		.036" Dia. Contact, .138" Leg Length, Thru Hole, Water Blue Color, Neutral Coding, D07 Mounting Hole	PE44650Z	\$5.88	\$5.47	\$5.06	\$4.70	16

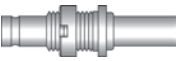
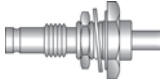
1.0/2.3 Connectors



Product Image	Attachment Cable/Contact	Coax Type / Termination Type	Model No.	Price				Row
				1-24	25-49	50-99	100 +	
Plug Straight, Cable Connectors								
	Crimp/Solder	RG174, RG316, RG188, Snap On	PE44244	\$9.70	\$9.02	\$8.34	\$7.76	17
		RG58, Snap On	PE44243	\$9.63	\$8.96	\$8.28	\$7.70	18
		RG55, RG142, RG223, RG400, Snap On	PE44242	\$9.05	\$8.42	\$7.78	\$7.24	19
Plug Right Angle, Cable Connectors								
	Crimp/Solder	RG174, RG316, RG188, Snap On	PE44249	\$11.70	\$10.88	\$10.06	\$9.36	20
		RG58, Snap On	PE44248	\$12.41	\$11.54	\$10.67	\$9.93	21
		RG55, RG142, RG223, RG400, Snap On	PE44247	\$11.25	\$10.46	\$9.68	\$9.00	22
Jack Straight, Bulkhead Mount, Cable Connectors								
	Crimp/Solder	RG174, RG316, RG188, Snap On, G06 Mounting Hole	PE44254	\$11.20	\$10.42	\$9.63	\$8.96	23
	Solder/Solder	PE-SR402AL, PE-SR402FL, RG402, Snap On, B02 Mounting Hole, .141" Semi-Rigid	PE44255	\$12.41	\$11.54	\$10.67	\$9.93	24
		PE-SR405AL, PE-SR405FL, RG405, Snap On, B02 Mounting Hole, .085" Semi-Rigid	PE44256	\$12.41	\$11.54	\$10.67	\$9.93	25
Jack Right Angle, Bulkhead Mount, Cable Connectors								
	Crimp/Solder	RG174, RG316, RG188, G05 Mounting Hole, Snap On	PE44261	\$12.97	\$12.06	\$11.15	\$10.38	26
		RG58, G05 Mounting Hole, Snap On	PE44260	\$12.97	\$12.06	\$11.15	\$10.38	27

See Our Website For Real-Time Stock Availability!

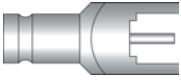
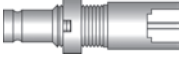
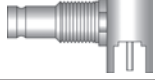

1.0/2.3 Connectors

Product Image	Attachment Cable/Contact	Coax Type / Termination Type	Model No.	Price				Row
				1-24	25-49	50-99	100 +	
Jack Straight, PCB Mount								
	Solder	.033" Dia. Contact, .138" Leg Length, Thru Hole, D07 Mounting Hole, Snap On	PE44257	\$6.43	\$5.98	\$5.53	\$5.14	1
Jack Straight, Bulkhead Mount, PCB Mount								
	Solder	.039" Dia. Contact, .138" Leg Length, Thru Hole, D07 & F09 Mounting Hole, Snap On	PE44259	\$9.07	\$8.44	\$7.80	\$7.26	2
Jack Right Angle, PCB Mount								
	Solder	.037" Dia. Contact, .142" Leg Length, Thru Hole, D07 Mounting Hole, Snap On	PE44258	\$8.56	\$7.96	\$7.36	\$6.85	3

MC-CARD Connectors

Product Image	Attachment Cable/Contact	Coax Type / Termination Type	Model No.	Price				Row
				1-24	25-49	50-99	100 +	
Plug Straight, Cable Connectors								
	Crimp/Solder	RG174, RG316, RG188	PE44309	\$9.07	\$8.44	\$7.80	\$7.26	4
		RG178, RG196	PE44310	\$9.07	\$8.44	\$7.80	\$7.26	5
Plug Right Angle, Cable Connectors								
	Crimp/Solder	RG174, RG316, RG188	PE44308	\$9.73	\$9.05	\$8.37	\$7.78	6
		RG178, RG196	PE44311	\$10.34	\$9.62	\$8.89	\$8.27	7

D-Sub Contacts

Product Image	Attachment Cable/Contact	Coax Type / Termination Type	Model No.	Price				Row
				1-24	25-49	50-99	100 +	
Plug Straight, Cable Connectors								
	Crimp/Solder	RG174, RG316, RG187, RG188	PE4809	\$11.43	\$10.63	\$9.83	\$9.14	8
		RG178, RG196	PE4810	\$11.60	\$10.79	\$9.98	\$9.28	9
		RG180, RG195	PE4811	\$11.60	\$10.79	\$9.98	\$9.28	10
		RG58, RG141, RG303	PE4808	\$11.60	\$10.79	\$9.98	\$9.28	11
		RG55, RG142, RG223, RG400	PE4842	\$11.70	\$10.88	\$10.06	\$9.36	12
	Solder/Solder	PE-047SR, PE-SR047AL, PE-SR047FL, .047" Semi-Rigid	PE4846	\$15.60	\$14.51	\$13.42	\$12.48	13
		PE-SR402AL, PE-SR402FL, RG402, .141" Semi-Rigid	PE4844	\$16.16	\$15.03	\$13.90	\$12.93	14
		PE-SR405AL, PE-SR405FL, RG405, .085" Semi-Rigid	PE4845	\$14.24	\$13.24	\$12.25	\$11.39	15
		RG174, RG316, RG187, RG188	PE4813	\$11.30	\$10.51	\$9.72	\$9.04	16
		RG178, RG196	PE4814	\$10.60	\$9.86	\$9.12	\$8.48	17
		RG180, RG195	PE4815	\$11.60	\$10.79	\$9.98	\$9.28	18
		RG58, RG141, RG303	PE4812	\$10.60	\$9.86	\$9.12	\$8.48	19
		RG55, RG142, RG223, RG400	PE4843	\$11.70	\$10.88	\$10.06	\$9.36	20
Plug Right Angle, Cable Connectors								
	Crimp/Solder	RG174, RG316, RG187, RG188	PE4825	\$11.60	\$10.79	\$9.98	\$9.28	21
		RG178, RG196	PE4826	\$11.60	\$10.79	\$9.98	\$9.28	22
		RG180, RG195	PE4827	\$11.60	\$10.79	\$9.98	\$9.28	23
		RG58, RG141, RG303	PE4824	\$11.60	\$10.79	\$9.98	\$9.28	24
		RG55, RG142, RG223, RG400	PE44035	\$11.90	\$11.07	\$10.23	\$9.52	25







Connectors

See Our Website For Real-Time Stock Availability!

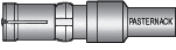
D-Sub Contacts

Connectors

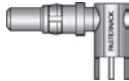

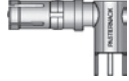
See Our Website For Real-Time Stock Availability!

Product Image	Attachment Cable/Contact	Coax Type / Termination Type	Model No.	Price				Row
				1-24	25-49	50-99	100 +	
	Solder/Solder	PE-047SR, PE-SR047AL, PE-SR047FL, .047" Semi-Rigid	PE44039	\$22.09	\$20.54	\$19.00	\$17.67	1
		PE-SR402AL, PE-SR402FL, RG402, .141" Semi-Rigid	PE44037	\$20.77	\$19.32	\$17.86	\$16.62	2
		PE-SR405AL, PE-SR405FL, RG405, .085" Semi-Rigid	PE44038	\$20.77	\$19.32	\$17.86	\$16.62	3
		RG174, RG316, RG187, RG188	PE4829	\$11.60	\$10.79	\$9.98	\$9.28	4
		RG178, RG196	PE4830	\$11.60	\$10.79	\$9.98	\$9.28	5
		RG180, RG195	PE4831	\$11.60	\$10.79	\$9.98	\$9.28	6
		RG58, RG141, RG303	PE4828	\$11.60	\$10.79	\$9.98	\$9.28	7
		RG55, RG142, RG223, RG400	PE44036	\$11.70	\$10.88	\$10.06	\$9.36	8
Receptacle Straight, Cable Connectors								
	Crimp/Solder	RG174, RG316, RG187, RG188	PE4801	\$11.59	\$10.78	\$9.97	\$9.27	9
		RG178, RG196	PE4802	\$9.07	\$8.44	\$7.80	\$7.26	10
		RG180, RG195	PE4803	\$9.07	\$8.44	\$7.80	\$7.26	11
		RG58, RG141, RG303	PE4800	\$11.59	\$10.78	\$9.97	\$9.27	12
		RG55, RG142, RG223, RG400	PE4837	\$9.60	\$8.93	\$8.26	\$7.68	13
	Solder/Solder	PE-047SR, PE-SR047AL, PE-SR047FL, .047" Semi-Rigid	PE4841	\$12.97	\$12.06	\$11.15	\$10.38	14
		PE-SR402AL, PE-SR402FL, RG402, .141" Semi-Rigid	PE4839	\$16.16	\$15.03	\$13.90	\$12.93	15
		PE-SR405AL, PE-SR405FL, RG405, .085" Semi-Rigid	PE4840	\$11.60	\$10.79	\$9.98	\$9.28	16
		RG174, RG316, RG187, RG188	PE4805	\$9.07	\$8.44	\$7.80	\$7.26	17
		RG178, RG196	PE4806	\$9.07	\$8.44	\$7.80	\$7.26	18
		RG180, RG195	PE4807	\$9.07	\$8.44	\$7.80	\$7.26	19
		RG58, RG141, RG303	PE4804	\$9.07	\$8.44	\$7.80	\$7.26	20
		RG55, RG142, RG223, RG400	PE4838	\$9.45	\$8.79	\$8.13	\$7.56	21
Receptacle Right Angle, Cable Connectors								
	Crimp/Solder	RG174, RG316, RG187, RG188	PE4817	\$23.15	\$21.53	\$19.91	\$18.52	22
		RG178, RG196	PE4818	\$11.60	\$10.79	\$9.98	\$9.28	23
		RG180, RG195	PE4819	\$10.60	\$9.86	\$9.12	\$8.48	24
		RG58, RG141, RG303	PE4816	\$11.60	\$10.79	\$9.98	\$9.28	25
		RG55, RG142, RG223, RG400	PE4847	\$11.70	\$10.88	\$10.06	\$9.36	26
	Solder/Solder	PE-047SR, PE-SR047AL, PE-SR047FL, .047" Semi-Rigid	PE44034	\$18.24	\$16.96	\$15.69	\$14.59	27
		PE-SR402AL, PE-SR402FL, RG402, .141" Semi-Rigid	PE4849	\$16.87	\$15.69	\$14.51	\$13.50	28
		PE-SR405AL, PE-SR405FL, RG405, .085" Semi-Rigid	PE44033	\$16.87	\$15.69	\$14.51	\$13.50	29
		RG174, RG316, RG187, RG188	PE4821	\$11.60	\$10.79	\$9.98	\$9.28	30
		RG178, RG196	PE4822	\$11.60	\$10.79	\$9.98	\$9.28	31
		RG180, RG195	PE4823	\$11.60	\$10.79	\$9.98	\$9.28	32
		RG58, RG141, RG303	PE4820	\$10.60	\$9.86	\$9.12	\$8.48	33
		RG55, RG142, RG223, RG400	PE4848	\$11.70	\$10.88	\$10.06	\$9.36	34
Plug Straight, PCB Mount								
	Solder	.031" Dia. Contact, .170" Leg Length, Thru Hole, J01 Mounting Hole	PE4833	\$12.16	\$11.31	\$10.46	\$9.73	35
Plug Right Angle, PCB Mount								
	Solder	.031" Dia. Contact, .157" Leg Length, Thru Hole, J01 Mounting Hole	PE4835	\$16.16	\$15.03	\$13.90	\$12.93	36
Receptacle Straight, PCB Mount								
	Solder	.031" Dia. Contact, .170" Leg Length, Thru Hole, J01 Mounting Hole	PE4832	\$11.60	\$10.79	\$9.98	\$9.28	37
Receptacle Right Angle, PCB Mount								
	Solder	.031" Dia. Contact, .157" Leg Length, Thru Hole, J01 Mounting Hole	PE4834	\$16.16	\$15.03	\$13.90	\$12.93	38

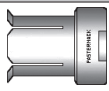
GR874 Connectors

Product Image	Attachment Cable/Contact	Coax Type / Termination Type	Model No.	Price				Row
				1-24	25-49	50-99	100 +	
Sexless Straight, Cable Connectors								
	Crimp/Solder	RG214, RG9, RG225, RG393	PE4352	\$69.06	\$64.23	\$59.39	\$55.25	1
		RG55, RG58, RG141, RG142, RG223, RG400	PE4233	\$69.06	\$64.23	\$59.39	\$55.25	2
Sexless Straight								
	Accessories	GR874 Rebuild Kit which includes Body, Contact, Insulator & Retaining Nut	PE4348	\$35.11	\$32.65	\$30.19	\$28.09	3

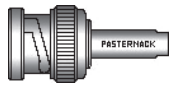
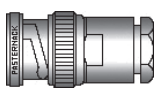
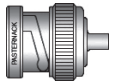
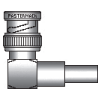
BNC Connectors

Product Image	Attachment Cable/Contact	Coax Type / Termination Type	Model No.	Price				Row		
				1-24	25-49	50-99	100 +			
Male Straight, Cable Connectors										
	Crimp/Solder	RG8X, PE-C240, B7808A	PE44640	\$10.74	\$9.99	\$9.24	\$8.59	4		
		RG188-DS, RG316-DS	PE4385	\$10.60	\$9.86	\$9.12	\$8.48	5		
		PE-B400, PE-C400	PE44294	\$22.34	\$20.78	\$19.21	\$17.87	6		
		PE-C200	PE44041	\$11.90	\$11.07	\$10.23	\$9.52	7		
		PE-B150, RG180, RG195	PE4247	\$9.58	\$8.91	\$8.24	\$7.66	8		
		PE-B305	PE4210	\$10.34	\$9.62	\$8.89	\$8.27	9		
		735A	PE44686	\$21.79	\$20.26	\$18.74	\$17.43	10		
		RG174, RG316, RG188	PE4043	\$7.60	\$7.07	\$6.54	\$6.08	11		
		RG178, RG196	PE4643	\$17.18	\$15.98	\$14.77	\$13.74	12		
		RG213, RG8	PE4378	\$18.20	\$16.93	\$15.65	\$14.56	13		
		RG214, RG9, RG225, RG393	PE4351	\$16.21	\$15.08	\$13.94	\$12.97	14		
		RG58	PE4016	\$5.35	\$4.98	\$4.60	\$4.28	15		
		RG59, RG62	PE4018	\$5.19	\$4.83	\$4.46	\$4.15	16		
		RG58 Plenum	PE4381	\$11.91	\$11.08	\$10.24	\$9.53	17		
		RG59 Plenum	PE4382	\$12.41	\$11.54	\$10.67	\$9.93	18		
		RG55, RG141, RG142, RG223, RG400	PE4044	\$4.97	\$4.62	\$4.27	\$3.98	19		
			Clamp/Solder	RG8X, PE-C240	PE4379	\$12.97	\$12.06	\$11.15	\$10.38	20
				PE-B400, PE-B405, PE-C400	PE4386	\$19.96	\$18.56	\$17.17	\$15.97	21
				PE-C200	PE44040	\$11.90	\$11.07	\$10.23	\$9.52	22
PE-C300	PE44042			\$11.90	\$11.07	\$10.23	\$9.52	23		
PE-B150, RG180, RG195	PE4383			\$26.19	\$24.36	\$22.52	\$20.95	24		
PE-SR401AL, PE-SR401FL, RG401, .250" Semi-Rigid	PE4380			\$18.80	\$17.48	\$16.17	\$15.04	25		
PE-SR402AL, PE-SR402FL, RG402, .141" Semi-Rigid	PE4206			\$15.35	\$14.28	\$13.20	\$12.28	26		
PE-SR405AL, PE-SR405FL, RG405, .085" Semi-Rigid	PE4207			\$17.65	\$16.41	\$15.18	\$14.12	27		
RG174, RG316, RG188	PE4084			\$9.28	\$8.63	\$7.98	\$7.42	28		
RG178, RG196	PE4384			\$12.95	\$12.04	\$11.14	\$10.36	29		
RG213, RG214, RG8, RG9, RG225, RG393, RG11	PE4109			\$11.70	\$10.88	\$10.06	\$9.36	30		
RG58, RG55, RG141, RG142, RG400, RG223	PE4023			\$5.25	\$4.88	\$4.52	\$4.20	31		
RG59, RG62	PE4024			\$6.50	\$6.05	\$5.59	\$5.20	32		
RG6	PE4377	\$11.60	\$10.79	\$9.98	\$9.28	33				
	Solder/Solder	PE-047SR, PE-SR047AL, PE-SR047FL, .047" Semi-Rigid	PE4974	\$23.66	\$22.00	\$20.35	\$18.93	34		
		PE-SR401AL, PE-SR401FL, RG401, .250" Semi-Rigid	PE4908	\$36.33	\$33.79	\$31.24	\$29.06	35		
		PE-SR402AL, PE-SR402FL, RG402, .141" Semi-Rigid	PE4650	\$18.39	\$17.10	\$15.82	\$14.71	36		
		PE-SR405AL, PE-SR405FL, RG405, .085" Semi-Rigid	PE4651	\$18.39	\$17.10	\$15.82	\$14.71	37		
Male Right Angle, Cable Connectors										
	Crimp/Solder	RG8X, PE-C240	PE44641	\$19.25	\$17.90	\$16.56	\$15.40	38		
		RG188-DS, RG316-DS	PE4396	\$21.60	\$20.09	\$18.58	\$17.28	39		
		RG174, RG316, RG188	PE4393	\$18.64	\$17.34	\$16.03	\$14.91	40		
		RG58	PE4298	\$16.42	\$15.27	\$14.12	\$13.14	41		
		RG59, RG62	PE4195	\$18.25	\$16.97	\$15.70	\$14.60	42		
	Clamp/Solder	RG55, RG141, RG142, RG223, RG400	PE4345	\$15.60	\$14.51	\$13.42	\$12.48	43		
		RG174, RG316, RG188	PE4307	\$20.47	\$19.04	\$17.60	\$16.38	44		
		RG178, RG196	PE4388	\$17.95	\$16.69	\$15.44	\$14.36	45		
		RG213, RG214, RG8, RG9, RG11, RG225, RG393	PE4387	\$25.84	\$24.03	\$22.22	\$20.67	46		
		RG59, RG62	PE4320	\$19.91	\$18.52	\$17.12	\$15.93	47		
		RG55, RG58, RG141, RG142, RG223, RG400,	PE4053	\$13.43	\$12.49	\$11.55	\$10.74	48		

Connectors

See Our Website For Real-Time Stock Availability!

Free Freight Available via UPS Ground to USA & Canada



Real-Time Stock Levels & Pricing On Our Website



Toil-Free Technical Support (866) 727-8376







Same-Day Shipping, Even Custom Cable Assemblies



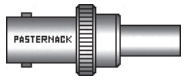

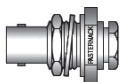

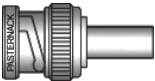
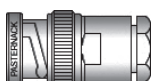

BNC Connectors

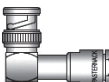
Connectors

See Our Website For Real-Time Stock Availability!

Product Image	Attachment Cable/Contact	Coax Type / Termination Type	Model No.	Price				Row		
				1-24	25-49	50-99	100 +			
	Solder/Solder	PE-SR402AL, PE-SR402FL, RG402, .141" Semi-Rigid	PE4092	\$25.84	\$24.03	\$22.22	\$20.67	1		
		PE-SR405AL, PE-SR405FL, RG405, .085" Semi-Rigid	PE4102	\$31.11	\$28.93	\$26.75	\$24.89	2		
Female Straight, Cable Connectors										
	Crimp/Solder	RG8X, PE-C240	PE44676	\$7.60	\$7.07	\$6.54	\$6.08	3		
		RG188-DS, RG316-DS	PE4390	\$11.90	\$11.07	\$10.23	\$9.52	4		
		735A	PE44688	\$21.79	\$20.26	\$18.74	\$17.43	5		
		RG174, RG316, RG188	PE4079	\$11.10	\$10.32	\$9.55	\$8.88	6		
		RG58	PE4070	\$6.66	\$6.19	\$5.73	\$5.33	7		
		RG59, RG62	PE4308	\$9.58	\$8.91	\$8.24	\$7.66	8		
		RG55, RG141, RG142, RG223, RG400	PE4397	\$7.90	\$7.35	\$6.79	\$6.32	9		
		PE-SR401AL, PE-SR401FL, RG401, .250" Semi-Rigid	PE44674	\$26.75	\$24.88	\$23.01	\$21.40	10		
		PE-SR402AL, PE-SR402FL, RG402, .141" Semi-Rigid	PE4204	\$21.60	\$20.09	\$18.58	\$17.28	11		
	Clamp/Solder	PE-SR405AL, PE-SR405FL, RG405, .085" Semi-Rigid	PE4205	\$21.60	\$20.09	\$18.58	\$17.28	12		
		RG174, RG316, RG188	PE4321	\$10.60	\$9.86	\$9.12	\$8.48	13		
		RG178, RG196	PE4389	\$14.35	\$13.35	\$12.34	\$11.48	14		
		RG213, RG214, RG8, RG9, RG11, RG225, RG393	PE4212	\$31.92	\$29.69	\$27.45	\$25.54	15		
		RG58, RG55, RG141, RG142, RG400, RG223	PE4058	\$6.98	\$6.49	\$6.00	\$5.58	16		
		RG59, RG62	PE4057	\$6.29	\$5.85	\$5.41	\$5.03	17		
		Female Straight, Bulkhead Mount, Cable Connectors								
			Crimp/Solder	RG188-DS, RG316-DS, B06 Mounting Hole	PE4392	\$14.35	\$13.35	\$12.34	\$11.48	18
				735A, B06 Mounting Hole	PE44687	\$21.79	\$20.26	\$18.74	\$17.43	19
RG174, RG316, RG188, B06 Mounting Hole	PE4106			\$11.96	\$11.12	\$10.29	\$9.57	20		
RG178, RG196, w/o-ring, B06 Mounting Hole	PE44658			\$12.87	\$11.97	\$11.07	\$10.30	21		
RG58, B06 Mounting Hole	PE4208			\$10.20	\$9.49	\$8.77	\$8.16	22		
RG59, RG62, B06 Mounting Hole	PE4309			\$13.22	\$12.29	\$11.37	\$10.58	23		
RG55, RG141, RG142, RG223, RG400, B06 Mounting Hole	PE4209			\$14.14	\$13.15	\$12.16	\$11.31	24		
PE-SR402AL, PE-SR402FL, RG402, B06 Mounting Hole, .141" Semi-Rigid	PE4915			\$25.20	\$23.44	\$21.67	\$20.16	25		
PE-SR405AL, PE-SR405FL, RG405, B06 Mounting Hole, .085" Semi-Rigid	PE4916			\$25.20	\$23.44	\$21.67	\$20.16	26		
	Clamp/Solder	RG174, RG316, RG188, B06 Mounting Hole	PE4319	\$12.95	\$12.04	\$11.14	\$10.36	27		
		RG178, RG196, B06 Mounting Hole	PE4391	\$15.60	\$14.51	\$13.42	\$12.48	28		
		RG213, RG214, RG8, RG9, RG11, RG225, RG393, B06 Mounting Hole	PE4632	\$35.11	\$32.65	\$30.19	\$28.09	29		
		RG58, RG55, RG141, RG142, RG400, RG223, B06 Mounting Hole	PE4078	\$12.48	\$11.61	\$10.73	\$9.98	30		
		RG59, RG62, B06 Mounting Hole	PE4310	\$23.66	\$22.00	\$20.35	\$18.93	31		
		Female Straight, Panel Mount, Cable Connectors								
			Clamp/Solder	4 Hole Flange, RG58, RG55, RG141, RG142, RG223, RG400, A03 Mounting Hole	PE4056	\$12.21	\$11.36	\$10.50	\$9.77	32
		Reverse Polarity Male Straight, Cable Connectors								
			Crimp/Solder	RG174, RG316, RG188	PE4720	\$18.59	\$17.29	\$15.99	\$14.87	33
RG213, RG8	PE4712			\$22.75	\$21.16	\$19.57	\$18.20	34		
RG214, RG9, RG393	PE4713			\$24.88	\$23.14	\$21.40	\$19.90	35		
RG58	PE4716			\$12.12	\$11.27	\$10.42	\$9.70	36		
RG59, RG62	PE4718			\$12.41	\$11.54	\$10.67	\$9.93	37		
RG55, RG141, RG142, RG223, RG400	PE4715			\$11.35	\$10.56	\$9.76	\$9.08	38		
PE-B400, PE-B405	PE4726			\$24.88	\$23.14	\$21.40	\$19.90	39		
PE-SR402AL, PE-SR402FL, RG402, .141" Semi-Rigid	PE4722			\$18.95	\$17.62	\$16.30	\$15.16	40		
PE-SR405AL, PE-SR405FL, RG405, .085" Semi-Rigid	PE4724			\$18.95	\$17.62	\$16.30	\$15.16	41		
	Clamp/Solder	RG174, RG316, RG188	PE4719	\$24.88	\$23.14	\$21.40	\$19.90	42		
		RG178, RG196	PE4721	\$22.30	\$20.74	\$19.18	\$17.84	43		
		RG213, RG214, RG8, RG9, RG225, RG393	PE4711	\$24.88	\$23.14	\$21.40	\$19.90	44		
		RG58, RG55, RG141, RG142, RG400, RG223	PE4714	\$24.88	\$23.14	\$21.40	\$19.90	45		
		RG59, RG62	PE4717	\$24.88	\$23.14	\$21.40	\$19.90	46		
		PE-SR402AL, PE-SR402FL, RG402, .141" Semi-Rigid	PE4723	\$24.88	\$23.14	\$21.40	\$19.90	47		
		PE-SR405AL, PE-SR405FL, RG405, .085" Semi-Rigid	PE4725	\$22.30	\$20.74	\$19.18	\$17.84	48		

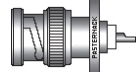
BNC Connectors

Product Image	Attachment Cable/Contact	Coax Type / Termination Type	Model No.	Price				Row
				1-24	25-49	50-99	100 +	
Reverse Polarity Male Right Angle, Cable Connectors								
	Crimp/Solder	RG174, RG316, RG188	PE4733	\$18.59	\$17.29	\$15.99	\$14.87	1
		RG58	PE4730	\$21.13	\$19.65	\$18.17	\$16.90	2
		RG55, RG141, RG142, RG223, RG400	PE4729	\$18.95	\$17.62	\$16.30	\$15.16	3
	Clamp/Solder	RG174, RG316, RG188	PE4732	\$22.30	\$20.74	\$19.18	\$17.84	4
		RG178, RG196	PE4734	\$22.30	\$20.74	\$19.18	\$17.84	5
		RG213, RG214, RG8, RG9, RG225, RG393	PE4727	\$31.11	\$28.93	\$26.75	\$24.89	6
		RG59, RG62	PE4731	\$24.88	\$23.14	\$21.40	\$19.90	7
		RG55, RG58, RG141, RG142, RG400, RG223	PE4728	\$24.88	\$23.14	\$21.40	\$19.90	8
Reverse Polarity Female Straight, Cable Connectors								
	Crimp/Solder	RG174, RG316, RG188	PE4742	\$18.59	\$17.29	\$15.99	\$14.87	9
		RG58	PE4738	\$18.59	\$17.29	\$15.99	\$14.87	10
		RG59, RG62	PE4739	\$18.59	\$17.29	\$15.99	\$14.87	11
		RG55, RG141, RG142, RG223, RG400	PE4737	\$17.00	\$15.81	\$14.62	\$13.60	12
	Clamp/Solder	PE-SR402AL, PE-SR402FL, RG402, .141" Semi-Rigid	PE4744	\$19.30	\$17.95	\$16.60	\$15.44	13
		PE-SR405AL, PE-SR405FL, RG405, .085" Semi-Rigid	PE4745	\$18.95	\$17.62	\$16.30	\$15.16	14
		RG174, RG316, RG188	PE4741	\$22.30	\$20.74	\$19.18	\$17.84	15
		RG178, RG196	PE4743	\$22.30	\$20.74	\$19.18	\$17.84	16
		RG213, RG214, RG8, RG9, RG393, RG225	PE4735	\$29.94	\$27.84	\$25.75	\$23.95	17
		RG59, RG62	PE4740	\$24.88	\$23.14	\$21.40	\$19.90	18
		RG55, RG58, RG141, RG142, RG400, RG223	PE4736	\$24.88	\$23.14	\$21.40	\$19.90	19
Reverse Polarity Female Straight, Bulkhead Mount, Cable Connectors								
	Crimp/Solder	RG174, RG316, RG188, B06 Mounting Hole	PE4752	\$21.13	\$19.65	\$18.17	\$16.90	20
		RG58, B06 Mounting Hole	PE4748	\$21.13	\$19.65	\$18.17	\$16.90	21
		RG59, RG62, B06 Mounting Hole	PE4750	\$21.13	\$19.65	\$18.17	\$16.90	22
		RG55, RG141, RG142, RG223, RG400, B06 Mounting Hole	PE4747	\$19.30	\$17.95	\$16.60	\$15.44	23
	Clamp/Solder	PE-SR402AL, PE-SR402FL, RG402, B06 Mounting Hole, .141" Semi-Rigid	PE4754	\$22.30	\$20.74	\$19.18	\$17.84	24
		PE-SR405AL, PE-SR405FL, RG405, B06 Mounting Hole, .085" Semi-Rigid	PE4755	\$22.30	\$20.74	\$19.18	\$17.84	25
		RG174, RG316, RG188, B06 Mounting Hole	PE4751	\$18.60	\$17.30	\$16.00	\$14.88	26
		RG178, RG196, B06 Mounting Hole	PE4753	\$18.60	\$17.30	\$16.00	\$14.88	27
		RG59, RG62, B06 Mounting Hole	PE4749	\$21.13	\$19.65	\$18.17	\$16.90	28
RG55, RG58, RG141, RG142, RG400, RG223, B06 Mounting Hole	PE4746	\$18.24	\$16.96	\$15.69	\$14.59	29		
Reverse Polarity Female Straight, Panel Mount, Cable Connectors								
	Clamp/Solder	4 Hole Flange, RG55, RG58, RG141, RG142, RG223, RG400, A03 Mounting Hole	PE4765	\$24.88	\$23.14	\$21.40	\$19.90	30
Male Straight, Bulkhead Mount, Terminal								
	Solder	Solder Cup Contact, .220" Max Panel, B04 Mounting Hole	PE4211	\$11.10	\$10.32	\$9.55	\$8.88	31
Male Straight, Panel Mount, Terminal								
	Solder	4 Hole Flange, Solder Cup Contact, A07 Mounting Hole	PE4082	\$12.06	\$11.22	\$10.37	\$9.65	32
Female Straight, Bulkhead Mount, Terminal								
	Solder	Solder Cup Contact, .250" Max Panel, B04 Mounting Hole	PE4015	\$5.02	\$4.67	\$4.32	\$4.02	33
		Solder Cup Contact, .125" Max Panel, B05 Mounting Hole	PE4014	\$4.91	\$4.57	\$4.22	\$3.93	34
		Wire Terminal, Hermetically Sealed, Front Mount, .250" Max Panel, B04 Mounting Hole	PE4077	\$12.90	\$12.00	\$11.09	\$10.32	35
		Wire Terminal, Hermetically Sealed, Rear Mount, .250" Max Panel, B06 Mounting Hole	PE4049	\$12.64	\$11.76	\$10.87	\$10.11	36
		Solder Cup Contact, Isolated Ground, .125" Max Panel, B04 Mounting Hole	PE4091	\$7.09	\$6.59	\$6.10	\$5.67	37
		Solder Cup Contact, Isolated Ground, .187" Max Panel, B06 Mounting Hole	PE4318	\$12.31	\$11.45	\$10.59	\$9.85	38

Connectors

See Our Website For Real-Time Stock Availability!

 Free Freight Available via UPS Ground to USA & Canada

 Real-Time Stock Levels & Pricing On Our WebSite







 Toll-Free Technical Support (866) 727-8376

 Same-Day Shipping, Even Custom Cable Assemblies

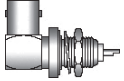

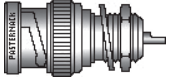

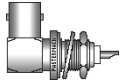
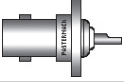

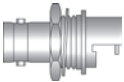
BNC Connectors

Connectors

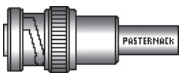
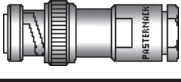
See Our Website For Real-Time Stock Availability!

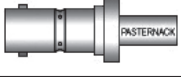
Product Image	Attachment Cable/Contact	Coax Type / Termination Type	Model No.	Price				Row
				1-24	25-49	50-99	100 +	
Female Right Angle, Bulkhead Mount, Terminal								
	Solder	Solder Cup Contact, .300" Max Panel, B13 Mounting Hole	PE4055	\$19.04	\$17.71	\$16.37	\$15.23	1
Female Straight, Panel Mount, Terminal								
	Solder	4 Hole Flange, Solder Cup Contact, A03 Mounting Hole	PE4010	\$6.29	\$5.85	\$5.41	\$5.03	2
		4 Hole Flange, Solder Cup Contact, 1.00" Flange Size, A05 Mounting Hole	PE4395	\$16.16	\$15.03	\$13.90	\$12.93	3
		4 Hole Flange, Solder Cup Contact, .687" Flange Size, A04 Mounting Hole	PE4394	\$9.02	\$8.39	\$7.76	\$7.22	4
		4 Hole Flange, Turret, A16 Mounting Hole	PE4011	\$14.24	\$13.24	\$12.25	\$11.39	5
Female Right Angle, Panel Mount, Terminal								
	Solder	4 Hole Flange, Solder Cup Contact, A16 Mounting Hole	PE4317	\$18.39	\$17.10	\$15.82	\$14.71	6
Reverse Polarity Male Straight, Bulkhead Mount, Terminal								
	Solder	Solder Cup Contact, .225" Max Panel, B04 Mounting Hole	PE4761	\$18.59	\$17.29	\$15.99	\$14.87	7
Reverse Polarity Male Straight, Panel Mount, Terminal								
	Solder	4 Hole Flange, Solder Cup Contact, A07 Mounting Hole	PE4762	\$18.59	\$17.29	\$15.99	\$14.87	8
Reverse Polarity Female Straight, Bulkhead Mount, Terminal								
	Solder	Solder Cup Contact, .250" Max Panel, B04 Mounting Hole	PE4758	\$11.60	\$10.79	\$9.98	\$9.28	9
		Solder Cup Contact, .125" Max Panel, B05 Mounting Hole	PE4757	\$11.60	\$10.79	\$9.98	\$9.28	10
		Solder Cup Contact, Isolated Ground, .180" Max Panel, B06 Mounting Hole	PE4764	\$15.60	\$14.51	\$13.42	\$12.48	11
Reverse Polarity Female Right Angle, Bulkhead Mount, Terminal								
	Solder	Solder Cup Contact, .300" Max Panel, B13 Mounting Hole	PE4759	\$37.34	\$34.73	\$32.11	\$29.87	12
Reverse Polarity Female Straight, Panel Mount, Terminal								
	Solder	4 Hole Flange, Solder Cup Contact, A04 Mounting Hole	PE4763	\$18.59	\$17.29	\$15.99	\$14.87	13
		4 Hole Flange, Solder Cup Contact, A03 Mounting Hole	PE4756	\$18.59	\$17.29	\$15.99	\$14.87	14
Reverse Polarity Female Right Angle, Panel Mount, Terminal								
	Solder	4 Hole Flange, Solder Cup Contact, A16 Mounting Hole	PE4760	\$37.34	\$34.73	\$32.11	\$29.87	15
Female Straight, PCB Mount								
	Solder	Surface Mount, Edge Launch Grip	PE44616	\$9.63	\$8.96	\$8.28	\$7.70	16
Female Straight, Bulkhead Mount, PCB Mount								
	Solder	Surface Mount, Edge Launch, .110" Max Panel, F02 Mounting Hole	PE44618	\$13.07	\$12.16	\$11.24	\$10.46	17

MHV Connectors

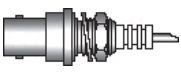
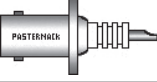
Product Image	Attachment Cable/Contact	Coax Type / Termination Type	Model No.	Price				Row		
				1-24	25-49	50-99	100 +			
Male Straight, Cable Connectors										
	Crimp/Solder	RG174, RG316, RG188	PE4933	\$29.39	\$27.33	\$25.28	\$23.51	1		
		RG213, RG8	PE4493	\$24.00	\$22.32	\$20.64	\$19.20	2		
		RG214, RG9, RG393	PE4350	\$24.57	\$22.85	\$21.13	\$19.66	3		
		RG58	PE4093	\$20.04	\$18.64	\$17.23	\$16.03	4		
		RG59, RG62	PE4075	\$11.55	\$10.74	\$9.93	\$9.24	5		
		RG55, RG141, RG142, RG223, RG400	PE4657	\$14.75	\$13.72	\$12.69	\$11.80	6		
	Clamp/Solder	RG174, RG316, RG188	PE4494	\$12.95	\$12.04	\$11.14	\$10.36	7		
		RG213, RG214, RG8, RG9, RG11, RG225, RG393	PE4299	\$23.51	\$21.86	\$20.22	\$18.81	8		
		RG58, RG55, RG141, RG142, RG400, RG223	PE4076	\$10.99	\$10.22	\$9.45	\$8.79	9		
		RG59, RG62	PE4098	\$11.30	\$10.51	\$9.72	\$9.04	10		
		Male Right Angle, Cable Connectors								
			Clamp/Solder	RG174, RG316, RG188	PE4710	\$25.20	\$23.44	\$21.67	\$20.16	11
RG213, RG214, RG8, RG9, RG11, RG225, RG393	PE4709			\$45.40	\$42.22	\$39.04	\$36.32	12		
RG58, RG55, RG141, RG142, RG400, RG223	PE4226			\$25.13	\$23.37	\$21.61	\$20.10	13		
RG59, RG62	PE4227			\$24.57	\$22.85	\$21.13	\$19.66	14		
Female Straight, Cable Connectors										
	Crimp/Solder	RG58	PE44102	\$21.13	\$19.65	\$18.17	\$16.90	15		
		RG59, RG62	PE44103	\$24.88	\$23.14	\$21.40	\$19.90	16		
		RG55, RG141, RG142, RG223, RG400	PE44100	\$22.75	\$21.16	\$19.57	\$18.20	17		
	Clamp/Solder	RG174, RG316, RG188	PE44104	\$21.60	\$20.09	\$18.58	\$17.28	18		
		RG213, RG214, RG8, RG9, RG11, RG225, RG393	PE4373	\$33.64	\$31.29	\$28.93	\$26.91	19		
		RG59, RG62	PE4181	\$17.18	\$15.98	\$14.77	\$13.74	20		
		RG55, RG58, RG141, RG142, RG223, RG400,	PE4225	\$18.24	\$16.96	\$15.69	\$14.59	21		
Female Straight, Bulkhead Mount, Cable Connectors										
	Crimp/Solder	RG58, B06 Mounting Hole	PE44108	\$27.31	\$25.40	\$23.49	\$21.85	22		
		RG59, RG62, B06 Mounting Hole	PE44110	\$32.37	\$30.10	\$27.84	\$25.90	23		
		RG55, RG141, RG142, RG223, RG400, B06 Mounting Hole	PE44107	\$25.70	\$23.90	\$22.10	\$20.56	24		
	Clamp/Solder	RG174, RG316, RG188, B06 Mounting Hole	PE44111	\$34.15	\$31.76	\$29.37	\$27.32	25		
		RG213, RG214, RG8, RG9, RG11, RG225, RG393, B06 Mounting Hole	PE44105	\$45.45	\$42.27	\$39.09	\$36.36	26		
		RG59, RG62, B06 Mounting Hole	PE44109	\$31.11	\$28.93	\$26.75	\$24.89	27		
		RG55, RG58, RG141, RG142, RG223, RG400, B06 Mounting Hole	PE44106	\$31.11	\$28.93	\$26.75	\$24.89	28		
Female Straight, Panel Mount, Cable Connectors										
	Clamp/Solder	4 Hole Flange, RG174, RG316, RG188, A03 Mounting Hole	PE44113	\$31.30	\$29.11	\$26.92	\$25.04	29		
		4 Hole Flange, RG213, RG214, RG8, RG9, RG11, RG225, RG393, A05 Mounting Hole	PE44112	\$37.34	\$34.73	\$32.11	\$29.87	30		
		4 Hole Flange, RG59, RG62, A03 Mounting Hole	PE4314	\$34.86	\$32.42	\$29.98	\$27.89	31		
		4 Hole Flange, RG55, RG58, RG141, RG142, RG223, RG400, A03 Mounting Hole	PE4313	\$34.86	\$32.42	\$29.98	\$27.89	32		
Female Straight, Bulkhead Mount, Terminal										
	Solder	Solder Cup Contact, Front Mount, w/o-ring, .218" Max Panel, G02 Mounting Hole	PE4193	\$15.30	\$14.23	\$13.16	\$12.24	33		
		Turret, Rear Mount, .125" Max Panel, B08 Mounting Hole	PE4312	\$27.36	\$25.44	\$23.53	\$21.89	34		
		Solder Cup Contact, Hermetically Sealed, Front Mount, .250" Max Panel, G02 Mounting Hole	PE4311	\$35.36	\$32.88	\$30.41	\$28.29	35		
		Solder Cup Contact, Hermetically Sealed, Rear Mount, .250" Max Panel, B06 Mounting Hole	PE4495	\$34.00	\$31.62	\$29.24	\$27.20	36		
Female Straight, Panel Mount, Terminal										
	Solder	4 Hole Flange, Solder Cup Contact, A03 Mounting Hole	PE4228	\$21.68	\$20.16	\$18.64	\$17.34	37		

Connectors

See Our Website For Real-Time Stock Availability!

The N connector was one of the first connectors capable of carrying microwave-frequency signals.



SHV Connectors

Connectors







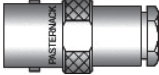

Product Image	Attachment Cable/Contact	Coax Type / Termination Type	Model No.	Price				Row
				1-24	25-49	50-99	100 +	
Plug Straight, Cable Connectors								
	Crimp/Solder	RG213, RG8	PE4496	\$26.45	\$24.60	\$22.75	\$21.16	1
		RG214, RG9, RG225, RG393	PE4349	\$27.11	\$25.21	\$23.31	\$21.69	2
		RG58	PE4194	\$28.53	\$26.53	\$24.54	\$22.82	3
		RG59, RG62	PE4343	\$28.53	\$26.53	\$24.54	\$22.82	4
		RG55, RG141, RG142, RG223, RG400	PE4497	\$26.45	\$24.60	\$22.75	\$21.16	5
	Clamp/Solder	RG174, RG316, RG188	PE4498	\$26.80	\$24.92	\$23.05	\$21.44	6
		RG213, RG214, RG8, RG9, RG225, RG393	PE4333	\$27.06	\$25.17	\$23.27	\$21.65	7
		RG58, RG55, RG141, RG142, RG400, RG223	PE4316	\$18.39	\$17.10	\$15.82	\$14.71	8
		RG59, RG62	PE4100	\$18.44	\$17.15	\$15.86	\$14.75	9
		Jack Straight, Bulkhead Mount, Cable Connectors						
	Clamp/Solder	RG174, RG316, RG188, B06 Mounting Hole	PE44093	\$34.80	\$32.36	\$29.93	\$27.84	10
		RG213, RG214, RG8, RG9, RG225, RG393, B06 Mounting Hole	PE44049	\$44.59	\$41.47	\$38.35	\$35.67	11
		RG58, RG55, RG141, RG142, RG400, RG223, B06 Mounting Hole	PE44080	\$34.35	\$31.95	\$29.54	\$27.48	12
		RG59, RG62, B06 Mounting Hole	PE4315	\$34.35	\$31.95	\$29.54	\$27.48	13
Plug Straight, Bulkhead Mount, Terminal								
	Solder	Solder Cup Contact, Front Mount, .218" Max Panel, B04 Mounting Hole	PE44118	\$35.26	\$32.79	\$30.32	\$28.21	14
Jack Straight, Bulkhead Mount, Terminal								
	Solder	Solder Cup Contact, Front Mount, .225" Max Panel, B04 Mounting Hole	PE4239	\$15.94	\$14.82	\$13.71	\$12.75	15
		Solder Cup Contact, Rear Mount, .250" Max Panel, B06 Mounting Hole	PE4499	\$19.98	\$18.58	\$17.18	\$15.98	16
		Solder Cup Contact, Hermetically Sealed, Front Mount, .250" Max Panel, B04 Mounting Hole	PE4500	\$47.12	\$43.82	\$40.52	\$37.70	17
Jack Straight, Panel Mount, Terminal								
	Solder	4 Hole Flange, Solder Cup Contact, A15 Mounting Hole	PE4501	\$22.87	\$21.27	\$19.67	\$18.30	18

C Connectors

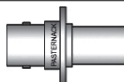
See Our Website For Real-Time Stock Availability!

Product Image	Attachment Cable/Contact	Coax Type / Termination Type	Model No.	Price				Row
				1-24	25-49	50-99	100 +	
Male Straight, Cable Connectors								
	Crimp/Solder	RG213, RG8	PE4518	\$26.20	\$24.37	\$22.53	\$20.96	19
		RG214, RG9, RG225, RG393	PE4375	\$21.13	\$19.65	\$18.17	\$16.90	20
		RG58	PE4517	\$26.15	\$24.32	\$22.49	\$20.92	21
		RG55, RG141, RG142, RG223, RG400	PE4445	\$20.42	\$18.99	\$17.56	\$16.34	22
		RG14, RG217	PE4951	\$43.52	\$40.47	\$37.43	\$34.82	23
	Clamp/Solder	RG174, RG316, RG188	PE4953	\$24.50	\$22.79	\$21.07	\$19.60	24
		RG213, RG214, RG8, RG9, RG11, RG225, RG393, High Voltage	PE4950	\$42.06	\$39.12	\$36.17	\$33.65	25
		RG213, RG214, RG8, RG9, RG11, RG225, RG393	PE4243	\$30.42	\$28.29	\$26.16	\$24.34	26
		RG218	PE4954	\$74.83	\$69.59	\$64.35	\$59.86	27
		RG58, RG55, RG141, RG142, RG400, RG223	PE4242	\$34.60	\$32.18	\$29.76	\$27.68	28
		RG59, RG62	PE4952	\$31.11	\$28.93	\$26.75	\$24.89	29
		Male Right Angle, Cable Connectors						
	Crimp/Solder	RG213, RG8	PE4955	\$51.20	\$47.62	\$44.03	\$40.96	30
		RG214, RG9, RG225, RG393	PE4949	\$58.92	\$54.80	\$50.67	\$47.14	31
		RG58	PE4959	\$61.10	\$56.82	\$52.55	\$48.88	32
		RG55, RG141, RG142, RG223, RG400	PE4958	\$51.20	\$47.62	\$44.03	\$40.96	33
	Clamp/Solder	RG213, RG214, RG8, RG9, RG11, RG225, RG393	PE4244	\$52.74	\$49.05	\$45.36	\$42.19	34
		RG58, RG55, RG141, RG142, RG400, RG223	PE4957	\$61.10	\$56.82	\$52.55	\$48.88	35

C Connectors

Product Image	Attachment Cable/Contact	Coax Type / Termination Type	Model No.	Price				Row
				1-24	25-49	50-99	100 +	
Female Straight, Cable Connectors								
	Clamp/Solder	RG14, RG217	PE4963	\$56.04	\$52.12	\$48.19	\$44.83	1
		RG213, RG214, RG8, RG9, RG11, RG225, RG393	PE4960	\$43.52	\$40.47	\$37.43	\$34.82	2
		RG58, RG55, RG141, RG142, RG400, RG223	PE4961	\$56.04	\$52.12	\$48.19	\$44.83	3
		RG59, RG62	PE4962	\$39.06	\$36.33	\$33.59	\$31.25	4
Female Straight, Bulkhead Mount, Cable Connectors								
	Clamp/Solder	RG213, RG214, RG8, RG9, RG11, RG225, RG393, Rear Mount, B07 Mounting Hole	PE4964	\$47.37	\$44.05	\$40.74	\$37.90	5
		RG58, RG55, RG141, RG142, RG400, RG223, Front Mount, B15 Mounting Hole	PE44099	\$49.91	\$46.42	\$42.92	\$39.93	6
		RG58, RG55, RG141, RG142, RG400, RG223, Rear Mount, B07 Mounting Hole	PE4965	\$56.04	\$52.12	\$48.19	\$44.83	7
		RG59, RG62, Front Mount, B15 Mounting Hole	PE44098	\$49.91	\$46.42	\$42.92	\$39.93	8
		RG59, RG62, Rear Mount, B07 Mounting Hole	PE4966	\$56.04	\$52.12	\$48.19	\$44.83	9
Female Straight, Panel Mount, Cable Connectors								
	Crimp/Solder	4 Hole Flange, RG213, RG8, A05 Mounting Hole	PE4968	\$39.10	\$36.36	\$33.63	\$31.28	10
		4 Hole Flange, RG214, RG9, RG225, RG393, A05 Mounting Hole	PE4374	\$49.91	\$46.42	\$42.92	\$39.93	11
	Clamp/Solder	4 Hole Flange, RG213, RG214, RG8, RG9, RG11, RG225, RG393, A19 Mounting Hole	PE4967	\$56.04	\$52.12	\$48.19	\$44.83	12
		4 Hole Flange, RG58, RG55, RG141, RG142, RG400, RG223, A19 Mounting Hole	PE4969	\$41.14	\$38.26	\$35.38	\$32.91	13
		4 Hole Flange, RG59, RG62, A19 Mounting Hole	PE4970	\$56.04	\$52.12	\$48.19	\$44.83	14
Male Straight, Bulkhead Mount, Terminal								
	Solder	Solder Cup Contact, Front Mount, .125" Max Panel, B04 Mounting Hole	PE44097	\$56.04	\$52.12	\$48.19	\$44.83	15
Male Straight, Panel Mount, Terminal								
	Solder	4 Hole Flange, Solder Cup Contact, A14 Mounting Hole	PE44096	\$44.48	\$41.37	\$38.25	\$35.58	16
Female Straight, Bulkhead Mount, Terminal								
	Solder	Solder Cup Contact, Rear Mount, .135" Max Panel, B07 Mounting Hole	PE4240	\$36.99	\$34.40	\$31.81	\$29.59	17
		Solder Cup Contact, Rear Mount, High Voltage, 3000 Volts, .135" Max Panel, B07 Mounting Hole	PE4972	\$56.04	\$52.12	\$48.19	\$44.83	18
		Turret, Front Mount, .115" Max Panel, B04 Mounting Hole	PE4973	\$56.04	\$52.12	\$48.19	\$44.83	19
		Solder Cup Contact, Hermetically Sealed, Rear Mount, .250" Max Panel, B07 Mounting Hole	PE4971	\$56.04	\$52.12	\$48.19	\$44.83	20
Female Straight, Panel Mount, Terminal								
	Solder	4 Hole Flange, Solder Cup Contact, A14 Mounting Hole	PE4241	\$16.52	\$15.36	\$14.21	\$13.22	21
		4 Hole Flange, Solder Cup Contact, High Voltage, 3000 Volts, A14 Mounting Hole	PE44117	\$25.84	\$24.03	\$22.22	\$20.67	22

Connectors

See Our Website For Real-Time Stock Availability!

75 Ohm N Connectors

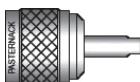
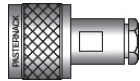
Product Image	Attachment Cable/Contact	Coax Type / Termination Type	Model No.	Price				Row
				1-24	25-49	50-99	100 +	
Male Straight, Cable Connectors								
	Crimp/Solder	RG179, RG187	PE4656	\$18.39	\$17.10	\$15.82	\$14.71	23
		RG59, RG62	PE4512	\$17.18	\$15.98	\$14.77	\$13.74	24
		RG11, RG144, RG216	PE4510	\$17.18	\$15.98	\$14.77	\$13.74	25
		RG6	PE4508	\$17.18	\$15.98	\$14.77	\$13.74	26
	Clamp/Solder	RG179, RG187	PE4513	\$15.35	\$14.28	\$13.20	\$12.28	27
		RG59, RG62	PE4511	\$15.96	\$14.84	\$13.73	\$12.77	28
		RG11, RG144, RG216	PE4509	\$21.13	\$19.65	\$18.17	\$16.90	29
		RG6	PE4507	\$15.96	\$14.84	\$13.73	\$12.77	30

Free Freight Available via UPS Ground to USA & Canada



Real-Time Stock Levels & Pricing On Our WebSite







Toll-Free Technical Support (866) 727-8376







Same-Day Shipping, Even Custom Cable Assemblies

75 Ohm N Connectors

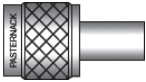
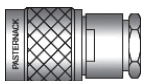
Product Image	Attachment Cable/Contact	Coax Type / Termination Type	Model No.	Price				Row
				1-24	25-49	50-99	100 +	
Male Right Angle, Cable Connectors								
	Clamp/Solder	RG11, RG144, RG216	PE4502	\$37.34	\$34.73	\$32.11	\$29.87	1
Female Straight, Cable Connectors								
	Clamp/Solder	RG59, RG62	PE4516	\$24.88	\$23.14	\$21.40	\$19.90	2
		RG11, RG144, RG216	PE4515	\$24.42	\$22.71	\$21.00	\$19.54	3
		RG6	PE4514	\$21.13	\$19.65	\$18.17	\$16.90	4
Male Straight, Panel Mount, Terminal								
	Solder	4 Hole Flange, Solder Cup Contact, A05 Mounting Hole	PE4504	\$17.18	\$15.98	\$14.77	\$13.74	5
Female Straight, Bulkhead Mount, Terminal								
	Solder	Solder Cup Contact, Front Mount, .260" Max Panel, G01 Mounting Hole	PE4505	\$19.15	\$17.81	\$16.47	\$15.32	6
		Solder Cup Contact, Front Mount, .125" Max Panel, F05 Mounting Hole	PE4506	\$12.21	\$11.36	\$10.50	\$9.77	7
Female Straight, Panel Mount, Terminal								
	Solder	4 Hole Flange, Solder Cup Contact, A05 Mounting Hole	PE4503	\$12.46	\$11.59	\$10.72	\$9.97	8

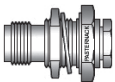

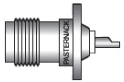



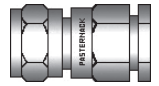

75 Ohm TNC Connectors

Product Image	Attachment Cable/Contact	Coax Type / Termination Type	Model No.	Price				Row
				1-24	25-49	50-99	100 +	
Male Straight, Cable Connectors								
	Crimp/Solder	RG179, RG187	PE44168	\$13.65	\$12.69	\$11.74	\$10.92	9
		RG59	PE44166	\$13.65	\$12.69	\$11.74	\$10.92	10
		RG11	PE44164	\$24.88	\$23.14	\$21.40	\$19.90	11
		RG6	PE44162	\$14.08	\$13.09	\$12.11	\$11.26	12
	Clamp/Solder	RG179, RG187	PE44167	\$13.40	\$12.46	\$11.52	\$10.72	13
		RG59	PE44165	\$13.40	\$12.46	\$11.52	\$10.72	14
		RG11, RG216	PE44163	\$38.20	\$35.53	\$32.85	\$30.56	15
		RG6	PE44161	\$17.85	\$16.60	\$15.35	\$14.28	16
Male Right Angle, Cable Connectors								
	Clamp/Solder	RG179, RG187	PE44172	\$37.34	\$34.73	\$32.11	\$29.87	17
		RG59	PE44171	\$37.34	\$34.73	\$32.11	\$29.87	18
		RG11, RG216	PE44170	\$37.34	\$34.73	\$32.11	\$29.87	19
		RG6	PE44169	\$37.34	\$34.73	\$32.11	\$29.87	20
Female Straight, Bulkhead Mount, Cable Connectors								
	Clamp/Solder	RG179, RG187, B06 Mounting Hole	PE44176	\$32.02	\$29.78	\$27.54	\$25.62	21
		RG59, B06 Mounting Hole	PE44175	\$35.26	\$32.79	\$30.32	\$28.21	22
		RG11, RG216, B06 Mounting Hole	PE44174	\$33.79	\$31.42	\$29.06	\$27.03	23
		RG6, B06 Mounting Hole	PE44173	\$31.11	\$28.93	\$26.75	\$24.89	24
Female Straight, Bulkhead Mount, Terminal								
	Solder	Solder Cup Contact, .200" Max Panel, B05 Mounting Hole	PE44177	\$12.97	\$12.06	\$11.15	\$10.38	25
		Solder Cup Contact, .125" Max Panel, B04 Mounting Hole	PE44180	\$16.16	\$15.03	\$13.90	\$12.93	26
		Solder Cup Contact, Isolated Ground, .180" Max Panel, B06 Mounting Hole	PE44181	\$18.59	\$17.29	\$15.99	\$14.87	27
Female Straight, Panel Mount, Terminal								
	Solder	4 Hole Flange, Solder Cup Contact, A03 Mounting Hole	PE44178	\$12.97	\$12.06	\$11.15	\$10.38	28

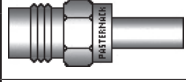
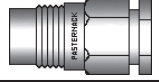
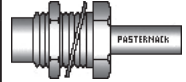
Connectors

See Our Website For Real-Time Stock Availability!



75 Ohm SMC Connectors (These Connectors will not mate with any 50 Ohm SMC Connectors)

Product Image	Attachment Cable/Contact	Coax Type / Termination Type	Model No.	Price				Row
				1-24	25-49	50-99	100 +	
Plug Straight, Cable Connectors								
	Crimp/Solder	RG179, RG187	PE4249	\$15.30	\$14.23	\$13.16	\$12.24	1
		RG180, RG195	PE4158	\$16.92	\$15.74	\$14.55	\$13.54	2
		RG59, RG62	PE4658	\$16.16	\$15.03	\$13.90	\$12.93	3
	Clamp/Solder	RG179, RG187	PE4259	\$32.37	\$30.10	\$27.84	\$25.90	4
		RG59, RG62	PE4258	\$32.37	\$30.10	\$27.84	\$25.90	5
Plug Right Angle, Cable Connectors								
	Crimp/Solder	RG179, RG187	PE4252	\$24.88	\$23.14	\$21.40	\$19.90	6
		RG180, RG195	PE4162	\$24.88	\$23.14	\$21.40	\$19.90	7
	Clamp/Solder	RG180, RG195	PE4267	\$24.88	\$23.14	\$21.40	\$19.90	8
		RG59, RG62	PE4266	\$24.88	\$23.14	\$21.40	\$19.90	9
Jack Straight, Cable Connectors								
	Crimp/Solder	RG179, RG187	PE4254	\$23.66	\$22.00	\$20.35	\$18.93	10
		RG180, RG195	PE4164	\$23.66	\$22.00	\$20.35	\$18.93	11
	Clamp/Solder	RG179, RG187	PE4929	\$23.66	\$22.00	\$20.35	\$18.93	12
		RG180, RG195	PE4275	\$23.66	\$22.00	\$20.35	\$18.93	13
		RG59, RG62	PE4274	\$23.66	\$22.00	\$20.35	\$18.93	14
Jack Straight, Bulkhead Mount, Cable Connectors								
	Crimp/Solder	RG179, RG187, B01 Mounting Hole	PE4256	\$23.66	\$22.00	\$20.35	\$18.93	15
		RG180, RG195, B01 Mounting Hole	PE4166	\$23.66	\$22.00	\$20.35	\$18.93	16
	Clamp/Solder	RG179, RG187, B01 Mounting Hole	PE4906	\$29.13	\$27.09	\$25.05	\$23.30	17
		RG180, RG195, B01 Mounting Hole	PE4283	\$23.66	\$22.00	\$20.35	\$18.93	18
		RG59, RG62, B01 Mounting Hole	PE4282	\$23.66	\$22.00	\$20.35	\$18.93	19
Plug Straight, Bulkhead Mount, Terminal								
	Solder	Solder Cup Contact, Front Mount, .125" Max Panel, B03 Mounting Hole	PE4291	\$32.37	\$30.10	\$27.84	\$25.90	20
Jack Straight, Bulkhead Mount, Terminal								
	Solder	Solder Cup Contact, Front Mount, .093" Max Panel, B03 Mounting Hole	PE4173	\$12.97	\$12.06	\$11.15	\$10.38	21
		Solder Cup Contact, Rear Mount, .093" Max Panel, B03 Mounting Hole	PE4169	\$28.73	\$26.72	\$24.71	\$22.98	22
Jack Right Angle, Bulkhead Mount, Terminal								
	Solder	Solder Cup Contact, Front Mount, .135" Max Panel, B03 Mounting Hole	PE4287	\$43.52	\$40.47	\$37.43	\$34.82	23
Plug Straight, PCB Mount								
	Solder	.036" Dia. Contact, .155" Leg Length, Thru Hole, D02 Mounting Hole	PE4369	\$27.36	\$25.44	\$23.53	\$21.89	24
Plug Right Angle, PCB Mount								
	Solder	.037" Dia. Contact, .155" Max Panel, Thru Hole, D02 Mounting Hole	PE4293	\$33.64	\$31.29	\$28.93	\$26.91	25







Connectors

See Our Website For Real-Time Stock Availability!

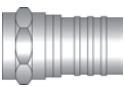
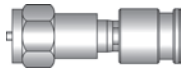
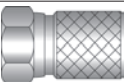
75 Ohm SMC Connectors (These Connectors will not mate with any 50 Ohm SMC Connectors)

Product Image	Attachment Cable/Contact	Coax Type / Termination Type	Model No.	Price				Row
				1-24	25-49	50-99	100 +	
Jack Straight, PCB Mount								
	Solder	.037" Dia. Contact, .155" Leg Length, Thru Hole, D02 Mounting Hole	PE4176	\$12.41	\$11.54	\$10.67	\$9.93	1
Jack Right Angle, PCB Mount								
	Solder	.037" Dia. Contact, .155" Max Panel, Thru Hole, D02 Mounting Hole	PE4180	\$19.91	\$18.52	\$17.12	\$15.93	2

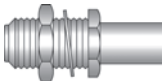

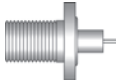
75 Ohm F Connectors

Product Image	Attachment Cable/Contact	Coax Type / Termination Type	Model No.	Price				Row
				1-24	25-49	50-99	100 +	
Male Straight, Cable Connectors								
	Crimp/Solder	PE-B159 Precision, High Definition, 1 Pieces Per Pack	PE44582	\$3.34	\$3.11	\$2.87	\$2.67	3
		RG6-Catv, 3 Piece Connector, 5 Pieces Per Pack	PE44313	\$3.09	\$2.87	\$2.66	\$2.47	4
		RG6-Catv, 10 Pieces Per Pack	PE44452	\$1.01	\$0.94	\$0.87	\$0.81	5
		RG179, RG187, 3 Piece Connector, 10 Pieces Per Pack	PE44319	\$2.03	\$1.89	\$1.75	\$1.62	6
		RG59, RG62, 10 Pieces Per Pack	PE44316	\$0.89	\$0.83	\$0.77	\$0.71	7
		RG59, RG62, 3 Piece Connector, 10 Pieces Per Pack	PE44317	\$2.31	\$2.15	\$1.99	\$1.85	8
		RG11, 3 Piece Connector, 5 Pieces Per Pack	PE44315	\$4.10	\$3.81	\$3.53	\$3.28	9
	Compression	RG6, 10 Pieces Per Pack	PE44312	\$1.10	\$1.02	\$0.95	\$0.88	10
		Mini 59, High Definition, 1 Piece Per Pack	PE44573	\$4.76	\$4.43	\$4.09	\$3.81	11
	Twist	PE-B159 Precision, High Definition, 1 Piece Per Pack	PE44572	\$4.41	\$4.10	\$3.79	\$3.53	12
		RG59, RG62, 10 Pieces Per Pack	PE44318	\$0.91	\$0.85	\$0.78	\$0.73	13
		RG6, 10 Pieces Per Pack	PE44314	\$0.91	\$0.85	\$0.78	\$0.73	14
Male Right Angle, Cable Connectors								
	Crimp/Solder	RG6-Catv, 5 Pieces Per Pack	PE44320	\$3.19	\$2.97	\$2.74	\$2.55	15
		RG59, RG62, 5 Pieces Per Pack	PE44322	\$4.15	\$3.86	\$3.57	\$3.32	16
	Compression	Mini 59, High Definition, 1 Piece Per Pack	PE44579	\$9.47	\$8.81	\$8.14	\$7.58	17
	Twist	RG6-Catv, 5 Pieces Per Pack	PE44321	\$3.39	\$3.15	\$2.92	\$2.71	18
		RG59, RG62, 5 Pieces Per Pack	PE44323	\$3.39	\$3.15	\$2.92	\$2.71	19
Female Straight, Bulkhead Mount, Cable Connectors								
	Crimp/Solder	RG6-Catv, B04 Mounting Hole, 5 Pieces Per Pack	PE44324	\$2.94	\$2.73	\$2.53	\$2.35	20
		RG179, RG187, G07 Mounting Hole, 5 Pieces Per Pack	PE44326	\$3.20	\$2.98	\$2.75	\$2.56	21
		RG59, RG62, B04 Mounting Hole, 5 Pieces Per Pack	PE44325	\$2.94	\$2.73	\$2.53	\$2.35	22
		PE-B159 Precision, High Definition, 1 Piece Per Pack, B06 Mounting Hole	PE44585	\$4.76	\$4.43	\$4.09	\$3.81	23
Female Straight, Bulkhead Mount, Terminal								
	Solder	.085" x .020" Tab Contact, Front Mount, .093" Max Panel, G07 Mounting Hole, 10 Pieces Per Pack	PE44327	\$1.22	\$1.13	\$1.05	\$0.98	24
		Pin Contact, Front Mount, .125" Max Panel, F05 Mounting Hole, 10 Pieces Per Pack	PE44330	\$1.52	\$1.41	\$1.31	\$1.22	25
Female Straight, Panel Mount, Terminal								
	Solder	4 Hole Flange, .030" Dia. Contact, A04 Mounting Hole, 5 Pieces Per Pack	PE44329	\$4.41	\$4.10	\$3.79	\$3.53	26



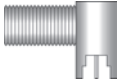

Connectors

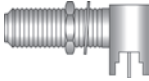
See Our Website For Real-Time Stock Availability!

75 Ohm F Connectors

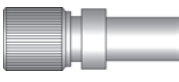
Product Image	Attachment Cable/Contact	Coax Type / Termination Type	Model No.	Price				Row
				1-24	25-49	50-99	100 +	
Female Straight, PCB Mount								
	Solder	.020" x .085" Tab Contact, .095" Leg Length, Thru Hole, D13 Mounting Hole, 10 Pieces Per Pack	PE44331	\$1.26	\$1.17	\$1.08	\$1.01	1
Female Right Angle, PCB Mount								
	Solder	.025" Dia. Contact, Thru Hole, D11 Mounting Hole, 5 Pieces Per Pack	PE44333	\$4.56	\$4.24	\$3.92	\$3.65	2
Female Straight, Bulkhead Mount, PCB Mount								
	Solder	.039" Dia. Contact, .300" Max Panel, Thru Hole, D14 Mounting Hole, 5 Pieces Per Pack	PE44332	\$4.41	\$4.10	\$3.79	\$3.53	3
Female Right Angle, Bulkhead Mount, PCB Mount								
	Solder	.025" Dia. Contact, .500" Max Panel, Thru Hole, D11 & B04 Mounting Hole, 5 Pieces Per Pack	PE44334	\$5.14	\$4.78	\$4.42	\$4.11	4

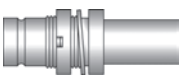

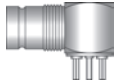

75 Ohm 1.6/5.6 Connectors

Product Image	Attachment Cable/Contact	Coax Type / Termination Type	Model No.	Price				Row
				1-24	25-49	50-99	100 +	
Plug Straight, Cable Connectors								
	Crimp/Solder	RG179, RG187	PE44262	\$11.60	\$10.79	\$9.98	\$9.28	5
		RG59	PE44263	\$10.99	\$10.22	\$9.45	\$8.79	6
Plug Right Angle, Cable Connectors								
	Clamp/Solder	RG179, RG187	PE44264	\$14.24	\$13.24	\$12.25	\$11.39	7
		RG59	PE44265	\$14.24	\$13.24	\$12.25	\$11.39	8
Jack Straight, Bulkhead Mount, Cable Connectors								
	Crimp/Solder	RG179, RG187, G04 Mounting Hole	PE44266	\$12.21	\$11.36	\$10.50	\$9.77	9
		RG59, G04 Mounting Hole	PE44267	\$12.97	\$12.06	\$11.15	\$10.38	10
Jack Right Angle, Bulkhead Mount, Cable Connectors								
	Crimp/Solder	RG179, RG187, G04 Mounting Hole	PE44268	\$14.24	\$13.24	\$12.25	\$11.39	11
		RG59, G04 Mounting Hole	PE44269	\$14.24	\$13.24	\$12.25	\$11.39	12
Jack Straight, Bulkhead Mount, PCB Mount								
	Solder	.039" Dia. Contact, .093" Max Panel, Thru Hole, D06 & F08 Mounting Hole	PE44270	\$12.97	\$12.06	\$11.15	\$10.38	13
Jack Right Angle, PCB Mount								
	Solder	.039" Dia. Contact, .130" Leg Length, Thru Hole, D06 Mounting Hole	PE44271	\$14.24	\$13.24	\$12.25	\$11.39	14

Connectors

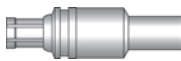
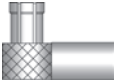
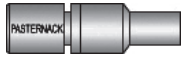
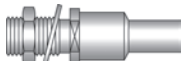
See Our Website For Real-Time Stock Availability!

75 Ohm MCX Connectors

Product Image	Attachment Cable/Contact	Coax Type / Termination Type	Model No.	Price				Row
				1-24	25-49	50-99	100 +	
Plug Straight, Cable Connectors								
	Crimp/Solder	RG179, RG187	PE44298	\$11.30	\$10.51	\$9.72	\$9.04	1
Plug Right Angle, Cable Connectors								
	Crimp/Solder	RG179, RG187	PE44299	\$14.24	\$13.24	\$12.25	\$11.39	2
Jack Straight, Cable Connectors								
	Crimp/Solder	RG179, RG187	PE44300	\$18.59	\$17.29	\$15.99	\$14.87	3
Jack Straight, Bulkhead Mount, Cable Connectors								
	Crimp/Solder	RG179, RG187, B01 Mounting Hole	PE44301	\$31.11	\$28.93	\$26.75	\$24.89	4
Jack Straight, Bulkhead Mount, Terminal								
	Solder	Solder Cup Contact, .125" Max Panel, B02 Mounting Hole	PE44306	\$18.59	\$17.29	\$15.99	\$14.87	5
Plug Straight, PCB Mount								
	Solder	.027" Dia. Contact, .155" Leg Length, Thru Hole, D10 Mounting Hole	PE44307	\$16.16	\$15.03	\$13.90	\$12.93	6
Jack Straight, PCB Mount								
	Solder	.068" End Launch, .028" Round Contact, .125" Leg Length	PE44305	\$11.60	\$10.79	\$9.98	\$9.28	7
		Surface Mount	PE44302	\$16.16	\$15.03	\$13.90	\$12.93	8
		.028" Dia. Contact, .155" Leg Length, Thru Hole, D08 Mounting Hole	PE44303	\$11.10	\$10.32	\$9.55	\$8.88	9
Jack Right Angle, PCB Mount								
	Solder	.020" Dia. Contact, .155" Leg Length, Thru Hole, D09 Mounting Hole	PE44304	\$16.72	\$15.55	\$14.38	\$13.38	10



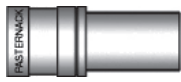
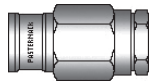









75 Ohm SMB Connectors (These Connectors will not mate with any 50 Ohm SMB Connectors)

Product Image	Attachment Cable/Contact	Coax Type / Termination Type	Model No.	Price				Row
				1-24	25-49	50-99	100 +	
Plug Straight, Cable Connectors								
	Crimp/Solder	RG179, RG187	PE4248	\$13.43	\$12.49	\$11.55	\$10.74	11
		RG179, RG187, Positive Snap, Will Mate to Standard 75 Ohm SMB Jack Connectors	PE44443	\$24.88	\$23.14	\$21.40	\$19.90	12
		RG180, RG195	PE4157	\$13.43	\$12.49	\$11.55	\$10.74	13
		RG180, RG195, Positive Snap, Will Mate to Standard 75 Ohm SMB Jack Connectors	PE44444	\$24.88	\$23.14	\$21.40	\$19.90	14
		RG59, RG62	PE4472	\$16.87	\$15.69	\$14.51	\$13.50	15
		RG59, RG62, Positive Snap, Will Mate to Standard 75 Ohm SMB Jack Connectors	PE44442	\$24.88	\$23.14	\$21.40	\$19.90	16
	Clamp/Solder	RG179, RG187	PE4257	\$17.63	\$16.40	\$15.16	\$14.10	17
		RG59, RG62	PE4203	\$15.60	\$14.51	\$13.42	\$12.48	18

Connectors

See Our Website For Real-Time Stock Availability!

75 Ohm SMB Connectors (These Connectors will not mate with any 50 Ohm SMB Connectors)

Product Image	Attachment Cable/Contact	Coax Type / Termination Type	Model No.	Price				Row
				1-24	25-49	50-99	100 +	
Plug Right Angle, Cable Connectors								
	Crimp/Solder	RG179, RG187	PE4251	\$19.25	\$17.90	\$16.56	\$15.40	1
		RG179, RG187, Positive Snap, Will Mate to Standard 75 Ohm SMB Jack Connectors	PE44445	\$27.36	\$25.44	\$23.53	\$21.89	2
		RG180, RG195	PE4161	\$24.88	\$23.14	\$21.40	\$19.90	3
		RG180, RG195, Positive Snap, Will Mate to Standard 75 Ohm SMB Jack Connectors	PE44446	\$27.36	\$25.44	\$23.53	\$21.89	4
	Clamp/Solder	RG180, RG195	PE4265	\$24.88	\$23.14	\$21.40	\$19.90	5
		RG59, RG62	PE4264	\$32.37	\$30.10	\$27.84	\$25.90	6
Jack Straight, Cable Connectors								
	Crimp/Solder	RG179, RG187	PE4253	\$32.37	\$30.10	\$27.84	\$25.90	7
		RG180, RG195	PE4163	\$16.87	\$15.69	\$14.51	\$13.50	8
	Clamp/Solder	RG179, RG187	PE4928	\$32.37	\$30.10	\$27.84	\$25.90	9
		RG180, RG195	PE4273	\$24.88	\$23.14	\$21.40	\$19.90	10
		RG59, RG62	PE4272	\$24.88	\$23.14	\$21.40	\$19.90	11
Jack Straight, Bulkhead Mount, Cable Connectors								
	Crimp/Solder	RG179, RG187, B01 Mounting Hole	PE4255	\$32.37	\$30.10	\$27.84	\$25.90	12
		RG180, RG195, B01 Mounting Hole	PE4165	\$29.79	\$27.70	\$25.62	\$23.83	13
	Clamp/Solder	RG179, RG187, B01 Mounting Hole	PE4925	\$22.09	\$20.54	\$19.00	\$17.67	14
		RG180, RG195, B01 Mounting Hole	PE4281	\$22.09	\$20.54	\$19.00	\$17.67	15
		RG59, RG62, B01 Mounting Hole	PE4280	\$35.77	\$33.27	\$30.76	\$28.62	16
Plug Straight, Bulkhead Mount, Terminal								
	Solder	Solder Cup Contact, Front Mount, .175" Max Panel, B03 Mounting Hole	PE4290	\$43.52	\$40.47	\$37.43	\$34.82	17
Jack Straight, Terminal								
	Solder	.038" Dia. Contact, .155" Leg Length, D02 Mounting Hole	PE4110	\$13.98	\$13.00	\$12.02	\$11.18	18
Jack Straight, Bulkhead Mount, Terminal								
	Solder	Solder Cup Contact, Front Mount, .093" Max Panel, B03 Mounting Hole	PE4172	\$12.97	\$12.06	\$11.15	\$10.38	19
		Solder Cup Contact, Rear Mount, .093" Max Panel, F10 Mounting Hole	PE4168	\$12.97	\$12.06	\$11.15	\$10.38	20
Jack Right Angle, Bulkhead Mount, Terminal								
	Solder	Solder Cup Contact, Front Mount, .093" Max Panel, B03 Mounting Hole	PE4286	\$49.91	\$46.42	\$42.92	\$39.93	21
Plug Straight, PCB Mount								
	Solder	.037" Dia. Contact, .155" Leg Length, Thru Hole, D02 Mounting Hole	PE4368	\$21.13	\$19.65	\$18.17	\$16.90	22
Plug Right Angle, PCB Mount								
	Solder	.037" Dia. Contact, .155" Leg Length, Thru Hole, D02 Mounting Hole	PE4292	\$42.76	\$39.77	\$36.77	\$34.21	23
Jack Right Angle, PCB Mount								
	Solder	.037" Dia. Contact, .155" Leg Length, Thru Hole, D02 Mounting Hole	PE4179	\$17.89	\$16.64	\$15.39	\$14.31	24

Connectors





See Our Website For Real-Time Stock Availability!

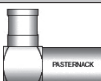

75 Ohm MINI SMB Connectors (These Connectors will not mate with any 50 Ohm SMB Connectors)

Connectors

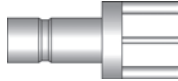
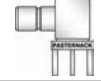

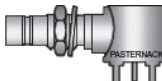

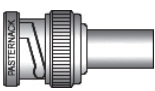
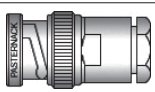

See Our Website For Real-Time Stock Availability!

Product Image	Attachment Cable/Contact	Coax Type / Termination Type	Model No.	Price				Row
				1-24	25-49	50-99	100 +	
Plug Straight, Cable Connectors								
	Crimp/Solder	RG179, RG187	PE4993	\$12.11	\$11.26	\$10.41	\$9.69	1
		RG59, RG62	PE4994	\$15.21	\$14.15	\$13.08	\$12.17	2
		PE-B159 Precision, High Definition	PE44588	\$21.48	\$19.98	\$18.47	\$17.18	3
Plug Right Angle, Cable Connectors								
	Crimp/Solder	RG179, RG187	PE4995	\$14.44	\$13.43	\$12.42	\$11.55	4
		RG59, RG62	PE4996	\$21.13	\$19.65	\$18.17	\$16.90	5
		PE-B159 Precision, High Definition	PE44589	\$26.19	\$24.36	\$22.52	\$20.95	6
Jack Straight, Cable Connectors								
	Crimp/Solder	PE-B159 Precision, High Definition	PE44590	\$20.27	\$18.85	\$17.43	\$16.22	7
Jack Straight, Panel Mount, Terminal								
	Solder	2 Hole Flange, Solder Cup Contact, C07 Mounting Hole	PE44141	\$17.63	\$16.40	\$15.16	\$14.10	8
Jack Straight, PCB Mount								
	Solder	.042" End Launch, .020" Round Contact, .187" Leg Length	PE44134	\$16.16	\$15.03	\$13.90	\$12.93	9
		.062" End Launch, .020" Round Contact, .187" Leg Length	PE44131	\$16.57	\$15.41	\$14.25	\$13.26	10
		.020" Dia. Contact, .155" Leg Length, Thru Hole, D09 Mounting Hole	PE4997	\$10.99	\$10.22	\$9.45	\$8.79	11
Jack Right Angle, PCB Mount								
	Solder	.020" Dia. Contact, Thru Hole, D09 Mounting Hole	PE4998	\$15.96	\$14.84	\$13.73	\$12.77	12
Jack Straight, Bulkhead Mount, PCB Mount								
	Solder	.020" Dia. Contact, .155" Leg Length, .093" Max Panel, Thru Hole, B01 & D09 Mounting Hole	PE44125	\$31.11	\$28.93	\$26.75	\$24.89	13
Jack Right Angle, Bulkhead Mount, PCB Mount								
	Solder	.020" Dia. Contact, .093" Max Panel, Thru Hole, B01 & D09 Mounting Hole	PE44128	\$19.96	\$18.56	\$17.17	\$15.97	14

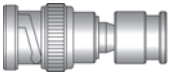
75 Ohm BNC Connectors

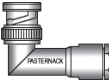
Product Image	Attachment Cable/Contact	Coax Type / Termination Type	Model No.	Price				Row		
				1-24	25-49	50-99	100 +			
Male Straight, Cable Connectors										
	Crimp/Solder	PE-B159 Precision, High Definition	PE44584	\$11.30	\$10.51	\$9.72	\$9.04	15		
		PE-B150	PE4633	\$10.74	\$9.99	\$9.24	\$8.59	16		
		PE-B305	PE4634	\$11.60	\$10.79	\$9.98	\$9.28	17		
		Mini 59, PE-B159, 3 Piece Connector	PE44625	\$7.09	\$6.59	\$6.10	\$5.67	18		
		Mini 59, PE-B159, High Definition	PE44630	\$11.30	\$10.51	\$9.72	\$9.04	19		
		RG179, RG187	PE4604	\$11.15	\$10.37	\$9.59	\$8.92	20		
		RG179-DS, 179DT, High Definition	PE44629	\$10.69	\$9.94	\$9.19	\$8.55	21		
		RG59	PE4602	\$10.99	\$10.22	\$9.45	\$8.79	22		
		PE-B1505, High Definition	PE44631	\$11.30	\$10.51	\$9.72	\$9.04	23		
		PE-B1694, High Definition	PE44632	\$11.30	\$10.51	\$9.72	\$9.04	24		
		RG11	PE4600	\$14.69	\$13.66	\$12.63	\$11.75	25		
		RG6	PE4598	\$15.81	\$14.70	\$13.60	\$12.65	26		
			Clamp/Solder	RG179, RG187	PE4603	\$10.99	\$10.22	\$9.45	\$8.79	27
				RG59	PE4601	\$11.70	\$10.88	\$10.06	\$9.36	28
RG11, RG216	PE4599			\$21.13	\$19.65	\$18.17	\$16.90	29		
RG6	PE4597			\$16.87	\$15.69	\$14.51	\$13.50	30		

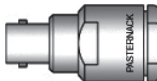
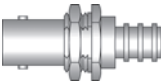
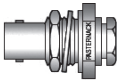
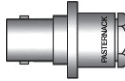
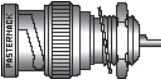
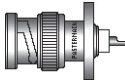
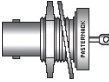



75 Ohm BNC Connectors

Product Image	Attachment Cable/Contact	Coax Type / Termination Type	Model No.	Price				Row
				1-24	25-49	50-99	100 +	
	Compression	Mini 59, High Definition	PE44578	\$11.86	\$11.03	\$10.20	\$9.49	1
		PE-B159 Precision, High Definition	PE44577	\$11.25	\$10.46	\$9.68	\$9.00	2
Male Right Angle, Cable Connectors								
	Crimp/Solder	RG179, RG187	PE4610	\$20.11	\$18.70	\$17.29	\$16.09	3
		RG59	PE4608	\$25.43	\$23.65	\$21.87	\$20.34	4
	Clamp/Solder	RG179, RG187	PE4609	\$24.88	\$23.14	\$21.40	\$19.90	5
		RG59	PE4607	\$22.34	\$20.78	\$19.21	\$17.87	6
		RG11, RG216	PE4606	\$27.36	\$25.44	\$23.53	\$21.89	7
		RG6	PE4605	\$22.34	\$20.78	\$19.21	\$17.87	8
	Compression	Mini 59, High Definition	PE44581	\$15.45	\$14.37	\$13.29	\$12.36	9
Female Straight, Cable Connectors								
	Crimp/Solder	RG179, RG187	PE4616	\$13.22	\$12.29	\$11.37	\$10.58	10
		RG59	PE4614	\$14.24	\$13.24	\$12.25	\$11.39	11
	Clamp/Solder	RG179, RG187	PE4615	\$18.59	\$17.29	\$15.99	\$14.87	12
		RG59	PE4613	\$14.08	\$13.09	\$12.11	\$11.26	13
		RG11, RG216	PE4612	\$20.77	\$19.32	\$17.86	\$16.62	14
		RG6	PE4611	\$32.37	\$30.10	\$27.84	\$25.90	15
Female Straight, Bulkhead Mount, Cable Connectors								
	Crimp/Solder	PE-B159, 1855A, B06 Mounting Hole	PE44587	\$15.45	\$14.37	\$13.29	\$12.36	16
		PE-B150, B06 Mounting Hole	PE4641	\$19.40	\$18.04	\$16.68	\$15.52	17
		PE-B305, B06 Mounting Hole	PE4642	\$19.40	\$18.04	\$16.68	\$15.52	18
		RG179, RG187, B06 Mounting Hole	PE4640	\$16.36	\$15.21	\$14.07	\$13.09	19
		RG59, B06 Mounting Hole	PE4638	\$20.82	\$19.36	\$17.91	\$16.66	20
	Clamp/Solder	RG179, RG187, B06 Mounting Hole	PE4639	\$22.30	\$20.74	\$19.18	\$17.84	21
		RG59, B06 Mounting Hole	PE4637	\$19.00	\$17.67	\$16.34	\$15.20	22
		RG11, RG216, B06 Mounting Hole	PE4636	\$37.34	\$34.73	\$32.11	\$29.87	23
		RG6, B06 Mounting Hole	PE4635	\$37.34	\$34.73	\$32.11	\$29.87	24
		Female Straight, Panel Mount, Cable Connectors						
	Clamp/Solder	4 Hole Flange, RG179, RG187, A03 Mounting Hole	PE44652	\$26.75	\$24.88	\$23.01	\$21.40	25
		4 Hole Flange, RG59, A03 Mounting Hole	PE4623	\$24.88	\$23.14	\$21.40	\$19.90	26
Male Straight, Bulkhead Mount, Terminal								
	Solder	Solder Cup Contact, .200" Max Panel, B04 Mounting Hole	PE4627	\$15.60	\$14.51	\$13.42	\$12.48	27
Male Straight, Panel Mount, Terminal								
	Solder	4 Hole Flange, Solder Cup Contact, A07 Mounting Hole	PE4625	\$15.96	\$14.84	\$13.73	\$12.77	28
Female Straight, Bulkhead Mount, Terminal								
	Solder	Solder Cup Contact, .250" Max Panel, B04 Mounting Hole	PE4620	\$9.68	\$9.00	\$8.32	\$7.74	29
		Solder Cup Contact, .125" Max Panel, B05 Mounting Hole	PE4619	\$6.66	\$6.19	\$5.73	\$5.33	30
		Wire Terminal, Rear Mount, Hermetically Sealed, .225" Max Panel, B06 Mounting Hole	PE4621	\$25.38	\$23.60	\$21.83	\$20.30	31
		Wire Terminal, Front Mount, Hermetically Sealed, .300" Max Panel, B04 Mounting Hole	PE4624	\$25.13	\$23.37	\$21.61	\$20.10	32
		Solder Cup Contact, Isolated Ground, .187" Max Panel, B06 Mounting Hole	PE4629	\$14.69	\$13.66	\$12.63	\$11.75	33
		Solder Cup Contact, Isolated Ground, .125" Max Panel, B04 Mounting Hole	PE4626	\$8.56	\$7.96	\$7.36	\$6.85	34
Female Right Angle, Bulkhead Mount, Terminal								
	Solder	Solder Cup Contact, .300" Max Panel, B13 Mounting Hole	PE4622	\$40.79	\$37.93	\$35.08	\$32.63	35

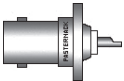

Connectors

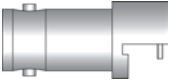
See Our Website For Real-Time Stock Availability!



75 Ohm BNC Connectors

Product Image	Attachment Cable/Contact	Coax Type / Termination Type	Model No.	Price				Row
				1-24	25-49	50-99	100 +	
Female Straight, Panel Mount, Terminal								
	Solder	4 Hole Flange, Solder Cup Contact, A03 Mounting Hole	PE4617	\$10.34	\$9.62	\$8.89	\$8.27	1
		4 Hole Flange, Solder Cup Contact, .687" Flange Size, A04 Mounting Hole	PE4630	\$12.97	\$12.06	\$11.15	\$10.38	2
		4 Hole Flange, Solder Cup Contact, 1.00" Flange Size, A05 Mounting Hole	PE4631	\$18.59	\$17.29	\$15.99	\$14.87	3
		4 Hole Flange, Turret, A07 Mounting Hole	PE4618	\$29.79	\$27.70	\$25.62	\$23.83	4
Female Right Angle, Panel Mount, Terminal								
	Solder	4 Hole Flange, Solder Cup Contact, A16 Mounting Hole	PE4628	\$37.34	\$34.73	\$32.11	\$29.87	5
Female Straight, PCB Mount								
	Solder	Surface Mount, Edge Launch Grip	PE44619	\$11.86	\$11.03	\$10.20	\$9.49	6
Female Straight, Bulkhead Mount, PCB Mount								
	Solder	Surface Mount, Edge Launch Grip, .110" Max Panel, F02 Mounting Hole	PE44620	\$12.87	\$11.97	\$11.07	\$10.30	7

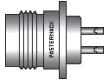
3/4"-20 Threaded Twinax Connectors

Product Image	Attachment Cable/Contact	Coax Type / Termination Type	Model No.	Price				Row
				1-24	25-49	50-99	100 +	
Male Straight, Cable Connectors								
	Clamp/Solder	PE-S330	PE4104	\$17.73	\$16.49	\$15.25	\$14.18	8
Female Straight, Cable Connectors								
	Clamp/Solder	PE-S330	PE4346	\$18.24	\$16.96	\$15.69	\$14.59	9
Female Straight, Bulkhead Mount, Terminal								
	Solder	Solder Cup Contact, B07 Mounting Hole	PE4105	\$18.24	\$16.96	\$15.69	\$14.59	10
Female Straight, Panel Mount, Terminal								
	Solder	4 Hole Flange, Solder Cup Contact, A05 Mounting Hole	PE4347	\$22.09	\$20.54	\$19.00	\$17.67	11

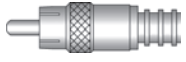
RCA Connectors

Product Image	Attachment Cable/Contact	Coax Type / Termination Type	Model No.	Price				Row
				1-24	25-49	50-99	100 +	
Plug Straight, Cable Connectors								
	Crimp/Solder	PE-B159 Precision, High Definition	PE44583	\$7.09	\$6.59	\$6.10	\$5.67	12
		Mini 59, PE-B159, High Definition (3 Pieces)	PE44622	\$10.74	\$9.99	\$9.24	\$8.59	13
	Compression	Mini 59, High Definition	PE44576	\$8.31	\$7.73	\$7.15	\$6.65	14
		PE-B159 Precision, High Definition	PE44574	\$8.31	\$7.73	\$7.15	\$6.65	15
		PE-B159 Precision, All Gold, High Definition	PE44575	\$11.86	\$11.03	\$10.20	\$9.49	16

Connectors

See Our Website For Real-Time Stock Availability!

RCA Connectors

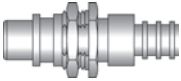
Product Image	Attachment Cable/Contact	Coax Type / Termination Type	Model No.	Price				Row
				1-24	25-49	50-99	100 +	
Plug Right Angle, Cable Connectors								
	Compression	Mini 59, High Definition	PE44580	\$14.24	\$13.24	\$12.25	\$11.39	1
Jack Straight, Bulkhead Mount, Cable Connectors								
	Crimp/Solder	PE-B159, High Definition, B06 Mounting Hole	PE44586	\$11.86	\$11.03	\$10.20	\$9.49	2

Banana Plug Connectors

Product Image	Attachment Cable/Contact	Coax Type / Termination Type	Model No.	Price				Row
				1-24	25-49	50-99	100 +	
Plug Straight, Cable Connectors								
	Crimp/Solder	RG174, RG316, RG188	PE44145	\$11.20	\$10.42	\$9.63	\$8.96	3
		RG58	PE4301	\$6.28	\$5.84	\$5.40	\$5.02	4
		RG55, RG142, RG223, RG400	PE4089	\$7.90	\$7.35	\$6.79	\$6.32	5

BNC Twinax Connectors

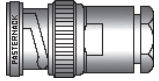
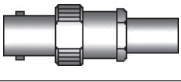
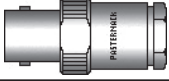
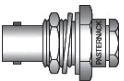
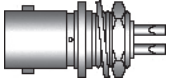
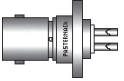
Product Image	Attachment Cable/Contact	Coax Type / Termination Type	Model No.	Price				Row
				1-24	25-49	50-99	100 +	
Plug Straight, Cable Connectors								
	Crimp/Solder	RG108, 78 Ohm Twinax	PE4234	\$15.47	\$14.39	\$13.30	\$12.38	6
	Clamp/Solder	RG108, 78 Ohm Twinax	PE4236	\$19.96	\$18.56	\$17.17	\$15.97	7
Jack Straight, Cable Connectors								
	Crimp/Solder	RG108, 78 Ohm Twinax	PE4235	\$24.88	\$23.14	\$21.40	\$19.90	8
	Clamp/Solder	RG108, 78 Ohm Twinax	PE4237	\$24.88	\$23.14	\$21.40	\$19.90	9
Jack Straight, Bulkhead Mount, Cable Connectors								
	Clamp/Solder	RG108, 78 Ohm Twinax, B06 Mounting Hole	PE44114	\$34.83	\$32.39	\$29.95	\$27.86	10
Jack Straight, Bulkhead Mount, Terminal								
	Solder	Solder Cup Contact, B04 Mounting Hole	PE4238	\$13.90	\$12.93	\$11.95	\$11.12	11
Jack Straight, Panel Mount, Terminal								
	Solder	4 Hole Flange, Solder Cup Contact, A03 Mounting Hole	PE4324	\$17.63	\$16.40	\$15.16	\$14.10	12

Connectors

See Our Website For Real-Time Stock Availability!

BNC Twinax Connectors

Connectors

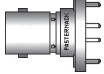
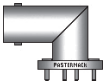
Product Image	Attachment Cable/Contact	Coax Type / Termination Type	Model No.	Price				Row
				1-24	25-49	50-99	100 +	
Jack Straight, PCB Mount								
	Solder	Thru Hole, H01 Mounting Hole	PE44115	\$20.06	\$18.66	\$17.25	\$16.05	1
Jack Right Angle, PCB Mount								
	Solder	Thru Hole, H01 Mounting Hole	PE44116	\$31.11	\$28.93	\$26.75	\$24.89	2

The FCC set standards that limit RF exposure to 601 microwatts per square centimeter.

Notes

See Our Website For Real-Time Stock Availability!

Adapter Selection Guide

3 Easy Ways to Find your Product.....

1. Search by PE Part Number

If you know the PE part number you are searching for, please reference our Part Number Index on Page 253.

2. Quick Reference Guide See pages 138-139 for our Adapter Matrix.

(Page number refers to first appearance of product in the Adapter Section)

Connector Series	Page	Connector Series	Page	Connector Series	Page	Connector Series	Page	Connector Series	Page
1.0/2.3	152	BNC-75 Ohm	176	MINI SMB-75 Ohm	176	Reverse Polarity MCX	152	SMC-75 Ohm	173
1.85mm	148	BNC Twinax	179	MINI SMP	155	Reverse Polarity N	159	SMP	151
10-32	167	C	162	MINI-UHF	160	Reverse Polarity SMA	147	SSMA	148
2.4mm	148	D-Sub Contacts	153	MMCX	151	Reverse Polarity TNC	150	SSMB	152
2.92mm	153	F	153	N-50 Ohm	148	Reverse Thread SMA	147	TNC-50 Ohm	149
3.5mm	147	FME	150	N-75 Ohm	162	SC	160	TNC-75 Ohm	175
3/4"-20 Twinax	178	GR874	153	PAL	175	SHV	174	UHF	150
7/16 DIN	150	HN	151	QMA	151	SMA	146	UMCX	151
7mm	154	LC	160	QN	161	SMB-50 Ohm	152		
Banana Plug	173	MCX	152	RCA	173	SMB-75 Ohm	173		
BNC-50 Ohm	152	MHV	169	Reverse Polarity BNC	172	SMC-50 Ohm	151		

Adapters

Adapter Locator Layout

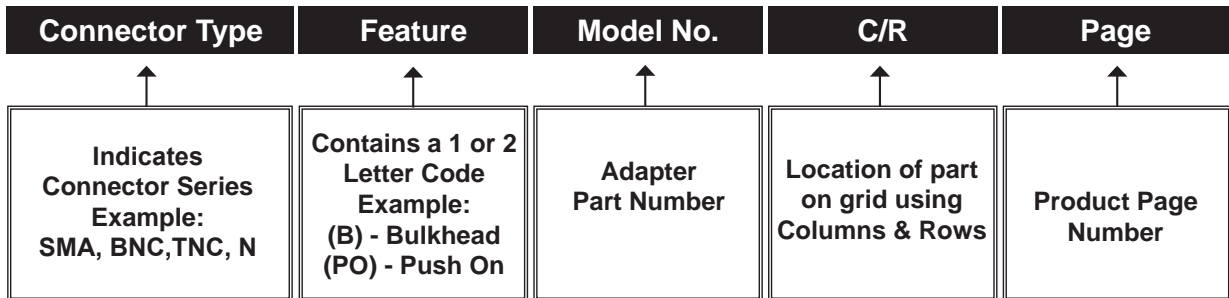

See Our Website For Real-Time Stock Availability!

3. Between-Series Adapter Locator

(Adapter Locator starts on Page 140)



SMA FEMALE TO TNC FEMALE
PE9079

SMA Female To:		EXAMPLE		
Connector Type	Feature	Model No.	C/R	Page
SSMA Male		PE9188	A4	163
SSMB Plug		PE9402	A3	167
TNC Female		PE9079	D6	164
TNC Female	(B)	PE9201	A1	165

TNC Female To:		EXAMPLE		
Connector Type	Feature	Model No.	C/R	Page
SMA Female	(P)	PE9442	C6	164
SMA Female		PE9079	D6	164
SMA Female	(B)	PE9201	A1	165
SMA Female	(PM)	PE9276	B1	165

The Adapter Locator example above includes Between-Series part numbers in two configurations:

Connector 1 to Connector 2 as well as Connector 2 to Connector 1 can be found in the same location.

Products can only be found under the first instance of the series combination. As an example, PE9079 above will be found in only one location in the Adapter Section.

Adapters Matrix

The number in the box represents the page number where the adapter is found.

Adapters

See Our Website For Real-Time Stock Availability!

Connectors	1.0 / 2.3	1.85mm	10-32	2.4mm	2.92mm	3.5mm	3/4"-20 Twinax	7/16	75 Ohm BNC	75 Ohm N	75 Ohm SMB	75 Ohm SMC	75 Ohm TNC	7mm	Binding Posts	BNC	C	Double Banana	D Subminiature	F	FME	GR874	HN
1.0 / 2.3																							
1.85mm		156		156	155	154																	
10-32			167													167							
2.4mm		156		155	155	154								156									
2.92mm		155		155	154	153								155									
3.5mm		154		154	153	153								154									
3/4"-20 Twinax							178																
7/16								164						165									165
75 Ohm BNC									178	176			176							177			
75 Ohm N									176	175	176	175	175							175			
75 Ohm SMB										176	177						173						
75 Ohm SMC										175		176				173							
75 Ohm TNC									176	175			176										
7mm				156	155	154		165								169							
Binding Posts																173							
BNC			167								173	173	169	173	173	172	172	173		173	166	173	169
C																172	174					174	169
Double Banana																173							
D Subminiature																			179				
F									177	175						173				177			
FME																166					166		
GR874																173	174					179	169
HN								165								169	169					169	168
LC																							168
MCX																170							
MHV																172							169
Mini 75 Ohm SMB									178		178												
Mini SMP					155																		
Mini UHF																166					166		
MMCX																170							
N		156		156	155	154		159		162				161			162			162	160	162	160
PAL																				177			
QMA																							
QN																							
RCA																173				177			
SC																168							
SHV																							
SMA	152	148		148		147		150						151		152			153	153	150	153	151
SMB																171							
SMC																167							
SMP																							
SSMA		156			155									157		157							
SSMB																171							
TNC								163						164		164	164				163		164
UHF																165				166	165		
UMCX																							

Adapters Matrix

The number in the box represents the page number where the adapter is found.

Connectors																								
	LC	MCX	MHV	Mini 75 Ohm SMB	Mini SMP	Mini UHF	MMCX	N	PAL	QMA	QN	RCA	SC	SHV	SMA	SMB	SMC	SMP	SSMA	SSMB	TNC	UHF	UMCX	
1.0 / 2.3															152									
1.85mm								156							148					156				
10-32																								
2.4mm								156							148									
2.92mm					155			155												155				
3.5mm								154							147									
3/4"-20 Twinax																								
7/16								159							150							163		
75 Ohm BNC				178																				
75 Ohm N								162																
75 Ohm SMB				178																				
75 Ohm SMC																								
75 Ohm TNC																								
7mm								161							151					157		164		
Binding Posts																								
BNC		170	172			166	170						173	168	152	171	167		157	171	164	165		
C								162														164		
Double Banana																								
D Subminiature															153									
F								162	177			177			153								166	
FME						166		160							150							163	165	
GR874								162							153									
HN	168		169					160							151							164		
LC	168							160																
MCX		170					170	161							152							164		
MHV			174											174										
Mini 75 Ohm SMB				178																				
Mini SMP					170																			
Mini UHF						166																	165	
MMCX		170					170								151									
N	160	161						157		161	161		160		148	161	160		157		159	160		
PAL									175															
QMA								161							151									
QN								161																
RCA																								
SC								160					168											
SHV			174											174										
SMA		152					151	148		151					146	152	151	151	148	152	149	150	151	
SMB								161							152	171	167							
SMC								160							151	167	167					164		
SMP															151			169						
SSMA								157							148				157					
SSMB															152									
TNC		164						159							149		164					162	163	
UHF						165		160							150							163	165	
UMCX															151									

Adapters

See Our Website For Real-Time Stock Availability!

Adapter Locator

Connector Type	Feature	Model No.	C/R	Page
75 Ohm TNC Male		PE9628	B4	175
F Female	(P)	PE9740	A1	176
F Male	(P)	PE9739	C6	175
F Male		PE9397	D6	175
Mini 75 Ohm SMB Jack		PE9615	A3	176
Mini 75 Ohm SMB Plug		PE9613	D2	176
N Male		PE9349	B4	162
75 Ohm N In-Series:				
Female To Female		PE9306	D2	175
Female To Female	(B) (H)	PE9416	A3	175
Female To Female	(B) (I)	PE9417	B3	175
Male To Female		PE9391	B2	175
Male To Female	90°	PE9307	C2	175
Male To Male		PE9308	A2	175
75 Ohm N Male To:				
75 Ohm BNC Female		PE9369	C3	176
75 Ohm BNC Male		PE9370	B3	176
75 Ohm SMB Jack		PE9582	C1	176
75 Ohm SMB Plug		PE9584	A1	176
75 Ohm SMC Jack		PE9586	B5	175
75 Ohm SMC Plug		PE9588	D4	175
75 Ohm TNC Female		PE9627	A4	175
75 Ohm TNC Male		PE9626	D3	175
F Female	(P)	PE9737	A6	175
F Female		PE9396	B6	175
F Male	(P)	PE9738	D5	175
Mini 75 Ohm SMB Jack		PE9614	C2	176
Mini 75 Ohm SMB Plug		PE9612	B2	176
N Female		PE9350	C4	162
75 Ohm SMB In-Series:				
Jack To Jack		PE9248	A1	178
Plug To Plug		PE9271	D6	177
T, Jack-Plug-Jack		PE9245	B1	178
75 Ohm SMB Jack To:				
75 Ohm N Female		PE9583	A2	176
75 Ohm N Male		PE9582	C1	176
BNC Female		PE9231	A4	173
BNC Male		PE9229	C3	173
Mini 75 Ohm SMB Plug		PE9735	A2	178
75 Ohm SMB Plug To:				
75 Ohm N Female		PE9585	D1	176
75 Ohm N Male		PE9584	B1	176
BNC Female		PE9232	D3	173
BNC Male		PE9230	B3	173
Mini 75 Ohm SMB Jack		PE9736	D1	178
75 Ohm SMC In-Series:				
Jack To Jack		PE9227	D6	176
Jack To Jack	(B)	PE9228	A1	177
Plug To Plug		PE9272	C6	176
T, Jack-Plug-Jack		PE9244	B1	177
75 Ohm SMC Jack To:				
75 Ohm N Female		PE9587	C5	175
75 Ohm N Male		PE9586	A5	175
BNC Female		PE9235	A2	173
BNC Male		PE9233	C1	173
75 Ohm SMC Plug To:				
75 Ohm N Female		PE9589	B5	175
75 Ohm N Male		PE9588	D4	175
BNC Female		PE9236	D1	173
BNC Male		PE9234	B1	173
75 Ohm TNC Female To:				
75 Ohm BNC Male		PE9630	A6	176
75 Ohm N Female		PE9629	C4	175
75 Ohm N Male		PE9627	A4	175
75 Ohm TNC In-Series:				
Female To Female		PE9622	D4	176
Female To Female	(B) (H)	PE9624	A5	176
Female To Female	(B) (I)	PE9625	B5	176
Male To Female	90°	PE9623	C4	176
75 Ohm TNC Male To:				
75 Ohm BNC Female		PE9631	D5	176
75 Ohm N Female		PE9628	B4	175
75 Ohm N Male		PE9626	D3	175
Banana Plug To:				
BNC Female (Double)		PE9008	C5	173
BNC Female (Single)		PE9175	D5	173
BNC Male (Double)		PE9009	D4	173

Connector Type	Feature	Model No.	C/R	Page
Binding Post To:				
BNC Female (Double)		PE9013	A6	173
BNC Male (Double)		PE9011	A5	173
BNC Male (Single)		PE9169	B5	173
BNC Female (Double) To:				
Banana Plug		PE9008	C5	173
Binding Post		PE9013	A6	173
BNC Female (Single) To:				
Banana Plug		PE9175	D5	173
BNC Female To:				
10-32 Female		PE9752	C1	168
10-32 Female	(B)	PE9754	D1	168
10-32 Male		PE9753	D6	167
10-32 Male	(B)	PE9755	A1	168
75 Ohm SMB Jack		PE9231	A4	173
75 Ohm SMB Plug		PE9232	D3	173
75 Ohm SMC Jack		PE9235	A2	173
75 Ohm SMC Plug		PE9236	D1	173
7mm	(P)	PE9220	A6	169
C Female		PE9537	D6	172
C Female	(B)	PE9204	A1	173
C Male		PE9087	C6	172
F Female		PE9153	A3	173
F Male		PE9151	D2	173
FME Jack		PE9712	C6	166
GR874		PE9222	C6	173
HN Male		PE9126	C3	169
MCX Jack		PE9466	C1	171
MCX Jack	(B)	PE9520	D1	171
MCX Plug		PE9467	A1	171
MHV Male		PE9297	D5	172
Mini UHF Male		PE9342	C4	166
MMCX Jack		PE9516	B5	170
MMCX Plug		PE9519	D4	170
N Female	(P)	PE9492	D1	162
N Female		PE9206	A2	162
N Female	(B)	PE9261	B2	162
N Female	(B)	PE9540	C2	162
N Female	(PM)	PE9238	D2	162
N Male	(P)	PE9491	D5	161
N Male		PE9002	A6	161
N Male	(PM)	PE9388	B6	161
N Male	90°	PE9278	C6	161
RCA Plug		PE9158	C4	173
Reverse Polarity BNC Male		PE9529	A5	172
SC Female		PE9571	C4	168
SC Male		PE9200	B4	168
SMA Female	(P)	PE9496	D6	152
SMA Female		PE9075	A1	153
SMA Female	(B)	PE9185	B1	153
SMA Female	(B)	PE9407	C1	153
SMA Male	(P)	PE9495	D5	152
SMA Male		PE9074	A6	152
SMB Jack		PE9136	C5	171
SMB Jack	(B)	PE9240	D5	171
SMB Plug		PE9137	D4	171
SMB Plug	(B)	PE9241	A5	171
SMC Jack		PE9140	A5	167
SMC Jack	(B)	PE9108	B5	167
SMC Plug		PE9141	C4	167
SSMA Male		PE9250	B5	157
SSMB Jack		PE9394	A1	172
SSMB Plug		PE9395	C6	171
TNC Female		PE9097	A5	164
TNC Female	(B) (H)	PE9483	B5	164
TNC Male		PE9088	B4	164
TNC Male	90°	PE9783	C4	164
UHF Female		PE9421	B1	166
UHF Male		PE9004	D6	165
BNC In-Series:				
Female To Female		PE9084	C2	172
Female To Female	(B) (H)	PE9093	D2	172
Female To Female	(B) (H)	PE9420	A3	172
Female To Female	(B) (I)	PE9172	B3	172
Female To Female	(PM)	PE9106	C3	172
Male To Female		PE9269	A2	172
Male To Female	90°	PE9085	B2	172
Male To Male		PE9000	C1	172
Male To Male	90°	PE9758	D1	172

Connector Type	Feature	Model No.	C/R	Page
T, Female-Female-Female		PE9003	C4	172
T, Female-Male-Female		PE9001	D3	172
T, Male-Female-Female		PE9174	A4	172
Y, Female-Male-Female		PE9484	B4	172
BNC Male (Double) To:				
Banana Plug		PE9009	D4	173
Binding Post		PE9011	A5	173
BNC Male (Single) To:				
Binding Post		PE9169	B5	173
BNC Male To:				
10-32 Female		PE9750	B1	168
10-32 Male		PE9751	C6	167
75 Ohm SMB Jack		PE9229	C3	173
75 Ohm SMB Plug		PE9230	B3	173
75 Ohm SMC Jack		PE9233	C1	173
75 Ohm SMC Plug		PE9234	B1	173
7mm	(P)	PE9221	D5	169
C Female		PE9109	B6	172
C Male		PE9536	A6	172
F Female		PE9150	C2	173
F Male		PE9152	B2	173
FME Jack		PE9711	B6	166
FME Plug		PE9697	D5	166
FME Plug	90°	PE9698	A6	166
GR874		PE9223	B6	173
HN Female		PE9129	D3	169
HN Male		PE9567	B3	169
MCX Jack		PE9468	B1	171
MCX Plug		PE9469	D6	170
MHV Female		PE9406	C5	172
Mini UHF Female		PE9341	D4	166
MMCX Jack		PE9518	A5	170
MMCX Plug		PE9517	C4	170
N Female	(P)	PE9490	D6	161
N Female		PE9005	A1	162
N Female	(PM)	PE9123	B1	162
N Female	90°	PE9566	C1	162
N Male	(P)	PE9489	A5	161
N Male		PE9127	B5	161
N Male	90°	PE9565	C5	161
RCA Jack		PE9171	B4	173
Reverse Polarity BNC Female		PE9530	D4	172
SC Male		PE9568	A4	168
SMA Female	(P)	PE9494	B6	152
SMA Female		PE9073	C6	152
SMA Male	(P)	PE9493	B5	152
SMA Male		PE9072	C5	152
SMB Jack		PE9132	B5	171
SMB Plug		PE9135	C4	171
SMC Jack		PE9138	D4	167
SMC Plug		PE9139	B4	167
SSMA Female		PE9191	C5	157
SSMA Male		PE9213	A5	157
SSMB Jack		PE9392	D6	171
SSMB Plug		PE9393	B6	171
TNC Female		PE9098	D4	164
TNC Male		PE9110	A4	164
UHF Female		PE9107	A1	166
UHF Male		PE9201	C6	165
BNC Twinax In-Series:				
Jack To Jack		PE9378	B4	179
Jack To Jack	(B)	PE9280	C4	179
Plug To Jack	90°	PE9377	A4	179
Plug To Plug		PE9376	D3	179
T, Jack-Jack-Jack		PE9279	A5	179
T, Jack-Plug-Jack		PE9375	D4	179
C Female To:				
BNC Female		PE9537	D6	172
BNC Female	(B)	PE9204	A1	173
BNC Male		PE9109	B6	172
GR874		PE9301	D6	174
HN Male		PE9296	C4	169
N Female		PE9539	A4	162
N Male		PE9124	B3	162
N Male	90°	PE9239	C3	162
TNC Male		PE9562	C5	164
C In-Series:				

Adapters

See Our Website For Real-Time Stock Availability!

Feature: (B) Bulkhead Mount / (H) Hermetically Sealed / (I) Isolated Sealed / (P) Precision / (PM) Panel Mount / (PO) Push On / (R) Radius Right Angle / (OD) Quick Disconnect (LP) Low PIM

 Free Freight Available via UPS Ground to USA & Canada	 Real-Time Stock Levels & Pricing On Our WebSite	 Toll-Free Technical Support (866) 727-8376	 Same-Day Shipping, Even Custom Cable Assemblies	141
---	---	--	---	-----

Adapter Locator

Connector Type	Feature	Model No.	C/R	Page
Female To Female	(B) 90°	PE9208	C5	174
Female To Female		PE9186	D5	174
Male To Female		PE9293	B5	174
Male To Male		PE9300	A5	174
T, Female-Female-Female		PE9294	B6	174
T, Female-Male-Female		PE9207	A6	174
C Male To:				
BNC Female		PE9087	C6	172
BNC Male		PE9536	A6	172
HN Female		PE9212	D4	169
HN Male		PE9579	B4	169
N Female		PE9295	D3	162
N Male		PE9538	A3	162
TNC Female		PE9564	D5	164
D Sub Contact In-Series:				
Plug To Plug		PE9688	A2	179
Plug To Receptacle		PE9687	B2	179
Receptacle To Receptacle		PE9689	C2	179
D Sub Contact Plug To:				
SMA Female		PE9422	B3	153
SMA Male		PE9425	C2	153
D Sub Contact Receptacle To:				
SMA Female		PE9423	C3	153
SMA Male		PE9424	D2	153
F Female To:				
75 Ohm BNC Female	(P)	PE9744	D5	177
75 Ohm BNC Male	(P)	PE9741	C5	177
75 Ohm N Female	(P)	PE9740	A1	176
75 Ohm N Male	(P)	PE9737	A6	175
75 Ohm N Male		PE9396	B6	175
BNC Female		PE9153	A3	173
BNC Male		PE9150	C2	173
N Male		PE9155	D4	162
PAL Jack		PE9634	D4	177
PAL Plug		PE9635	C4	177
RCA Jack		PE9168	B6	177
RCA Plug		PE9163	A6	177
SMA Female		PE91002	B2	153
SMA Male		PE91003	D1	153
UHF Female		PE9167	D1	166
UHF Male		PE9165	C1	166
F In-Series:				
Female To Female	(P)	PE9761	A3	177
Female To Female		PE9164	B3	177
Female To Female	(B)	PE9734	C3	177
Male To Female	(P)	PE9759	B2	177
Male To Female	(PO)	PE9160	C2	177
Male To Female	90°	PE9166	D2	177
Male To Male	(P)	PE9760	D1	177
Male To Male		PE9159	A2	177
F Male To:				
75 Ohm BNC Female	(P)	PE9743	B5	177
75 Ohm BNC Male	(P)	PE9742	A5	177
75 Ohm N Female	(P)	PE9739	C6	175
75 Ohm N Female		PE9397	D6	175
75 Ohm N Male	(P)	PE9738	D5	175
BNC Female		PE9151	D2	173
BNC Male		PE9152	B2	173
N Female		PE9389	A5	162
N Male		PE9632	B4	177
PAL Jack		PE9633	A4	177
PAL Plug		PE9633	A4	177
SMA Female		PE91001	A2	153
FME In-Series:				
Plug To Plug		PE9696	B5	166
FME Jack To:				
BNC Female		PE9712	C6	166
BNC Male		PE9711	B6	166
Mini UHF Female		PE9710	B4	166
Mini UHF Male		PE9709	A4	166
SMA Female		PE9708	B1	151
SMA Male		PE9707	D6	150
TNC Female		PE9714	C1	164
TNC Male		PE9713	B1	164
FME Plug To:				
BNC Male	90°	PE9697	D5	166
BNC Male		PE9698	A6	166
Mini UHF Male		PE9705	C3	166
Mini UHF Male	90°	PE9706	D3	166

Connector Type	Feature	Model No.	C/R	Page
N Male		PE9704	C3	160
SMA Female		PE9703	A1	151
SMA Male		PE9702	C6	150
TNC Male		PE9699	D6	163
TNC Male	90°	PE9700	A1	164
UHF Male		PE9701	B6	165
GR874 In-Series:				
GR874 To GR874	90°	PE9286	A3	179
T, GR874-GR874-GR874		PE9285	B3	179
GR874 To:				
BNC Female		PE9222	C6	173
BNC Male		PE9223	B6	173
C Female		PE9301	D6	174
HN Female		PE9387	B5	169
HN Male		PE9386	A5	169
N Female		PE9258	C5	162
N Male		PE9257	B5	162
SMA Female		PE9260	A4	153
SMA Male		PE9259	D3	153
HN Female To:				
7/16 DIN Male		PE9558	A3	165
BNC Male		PE9129	D3	169
C Male		PE9212	D4	169
GR874		PE9387	B5	169
LC Male		PE9181	A6	168
N Female		PE9360	B1	161
N Female	(PM)	PE9553	C1	161
N Male		PE9125	D6	160
SMA Female		PE9255	B3	151
SMA Male		PE9256	D2	151
HN In-Series:				
Female To Female		PE9580	D1	169
Female To Female	(B)	PE9193	A2	169
Male To Female		PE9576	B1	169
Male To Female	90°	PE9205	C1	169
Male To Male		PE9210	D6	168
Male To Male	90°	PE9577	A1	169
T, Female-Female-Female		PE9574	B3	169
T, Female-Male-Female		PE9575	D2	169
T, Male-Female-Male		PE9578	C2	169
HN Male To:				
7/16 DIN Female		PE9559	B3	165
BNC Female		PE9126	C3	169
BNC Male		PE9567	B3	169
C Female		PE9296	C4	169
C Male		PE9579	B4	169
GR874		PE9386	A5	169
LC Female		PE9413	B6	168
MHV Female		PE9264	A4	169
N Female		PE9194	A1	161
N Male		PE9554	C6	160
SMA Female		PE9253	A3	151
SMA Male		PE9254	C2	151
TNC Male		PE9563	A2	164
LC Female To:				
HN Male		PE9413	B6	168
N Female		PE9298	B6	160
N Male		PE9299	D5	160
LC In-Series:				
Female To Female		PE9419	C5	168
Male To Female	90°	PE9398	B5	168
Male To Male		PE9569	A5	168
LC Male To:				
HN Female		PE9181	A6	168
N Female		PE9237	A6	160
MCX In-Series:				
Jack To Jack		PE9524	A6	170
Jack To Jack	(B)	PE9474	B6	170
Plug To Jack		PE9479	D5	170
MCX Jack To:				
BNC Female	(B)	PE9466	C1	171
BNC Female		PE9520	D1	171
BNC Male		PE9468	B1	171
MMCX Jack		PE9526	B4	170
MMCX Plug		PE9525	D3	170
N Female		PE9462	D3	161
N Male		PE9464	B3	161
SMA Female		PE9470	B2	152

Connector Type	Feature	Model No.	C/R	Page
SMA Male		PE9472	D1	152
TNC Female	(B)	PE9544	C3	164
TNC Female		PE9521	D3	164
TNC Male		PE9542	A3	164
MCX Plug To:				
BNC Female		PE9467	A1	171
BNC Male		PE9469	D6	170
MMCX Jack		PE9528	A4	170
MMCX Plug		PE9527	C3	170
N Female		PE9463	C3	161
N Male		PE9465	A3	161
SMA Female		PE9471	A2	152
SMA Male		PE9473	C1	152
TNC Female		PE9545	B3	164
TNC Male		PE9543	D2	164
MHV Female To:				
BNC Male		PE9406	C5	172
HN Male		PE9264	A4	169
SHV Jack		PE9339	A3	174
SHV Plug		PE9265	D2	174
MHV In-Series:				
Female To Female	(B) (H) 90°	PE9267	B1	174
Female To Female		PE9268	C1	174
Male To Female		PE9266	A1	174
T, Female-Male-Female		PE9211	D1	174
MHV Male To:				
BNC Female		PE9297	D5	172
SHV Jack		PE9335	C2	174
SHV Plug		PE9340	B2	174
Mini 75 Ohm SMB In-Series:				
Jack To Jack	(B)	PE9608	A3	178
Jack To Jack		PE9611	B3	178
Plug To Jack		PE9610	D2	178
Plug To Plug		PE9609	C2	178
Mini 75 Ohm SMB Jack To:				
75 Ohm BNC Female		PE9619	B4	178
75 Ohm BNC Male		PE9618	A4	178
75 Ohm N Female		PE9615	A3	176
75 Ohm N Male		PE9614	C2	176
75 Ohm SMB Plug		PE9736	D1	178
Mini 75 Ohm SMB Plug To:				
75 Ohm BNC Female		PE9617	D3	178
75 Ohm BNC Male		PE9616	C3	178
75 Ohm N Female		PE9613	D2	176
75 Ohm N Male		PE9612	B2	176
75 Ohm SMB Jack		PE9735	A2	178
Mini SMP Female To:				
2.92mm Female	(P)	PE9782	A6	155
Mini SMP In-Series:				
Female To Female		PE9780	A2	170
Mini SMP Male To:				
2.92mm Female	(P)	PE9781	D5	155
Mini UHF Female To:				
BNC Male		PE9341	D4	166
FME Jack		PE9710	B4	166
N Male		PE9064	A3	160
TNC Male		PE9345	B6	163
UHF Male		PE9348	D5	165
Mini UHF In-Series:				
Female To Female	90°	PE9343	C2	166
Male To Female		PE9347	B2	166
T, Female-Female-Female		PE9066	A3	166
T, Female-Male-Female		PE9065	D2	166
Mini UHF Male To:				
BNC Female	90°	PE9342	C4	166
FME Jack		PE9709	A4	166
FME Plug		PE9705	C3	166
FME Plug		PE9706	D3	166
N Female		PE9183	B3	160
TNC Female		PE9346	C6	163
UHF Female	PE9344	A6	165	
MMCX In-Series:				
Jack To Jack	(B)	PE9523	D2	170
Jack To Jack		PE9522	A3	170
Plug To Jack		PE9480	C2	170
MMCX Jack To:				
BNC Female		PE9516	B5	170

Feature: (B) Bulkhead Mount / (H) Hermetically Sealed / (I) Isolated Sealed / (P) Precision / (PM) Panel Mount / (PO) Push On / (R) Radius Right Angle / (QD) Quick Disconnect (LP) Low PIM

Adapter Locator

Connector Type	Feature	Model No.	C/R	Page	Connector Type	Feature	Model No.	C/R	Page	Connector Type	Feature	Model No.	C/R	Page
BNC Male		PE9518	A5	170	TNC Male	(P)	PE9447	C3	159	SC Male		PE9570	D4	160
MCX Jack		PE9526	B4	170	TNC Male		PE9089	D3	159	SMA Female	(P)	PE9430	D6	148
MCX Plug		PE9528	A4	170	TNC Male	90°	PE9263	A4	159	SMA Female	(P) (PM)	PE9498	A1	149
SMA Female		PE9477	B1	152	UHF Female		PE9385	D2	160	SMA Female		PE9081	B1	149
SMA Male		PE9478	D6	151	UHF Male		PE9112	C2	160	SMA Female	(QD)	PE9684	C1	149
MMCX Plug To:					N In-Series:									
BNC Female		PE9519	D4	170	Cross, Female-		PE9548	D6	158	SMA Female	(B)	PE9551	D1	149
BNC Male		PE9517	C4	170	Female-					SMA Female	(PM)	PE9275	A2	149
MCX Jack		PE9525	D3	170	Female-Female					SMA Male	(P)	PE9431	C4	148
MCX Plug		PE9527	C3	170	Cross, Female-					SMA Male	(PM) (P)	PE9499	D4	148
SMA Female		PE9475	A1	152	Female-		PE9549	C6	158	SMA Male		PE9080	A5	148
SMA Male		PE9476	C6	151	Female-Male					SMB Jack		PE9313	B4	161
N Female To:														
1.85mm Female	(P)	PE9721	B1	157	Female To Female	(P)	PE9428	D2	158	SMB Plug		PE9314	A4	161
1.85mm Male	(P)	PE9719	D6	156	Female To Female	(LP)	PE91035	A3	158	SMC Jack		PE9317	A4	160
2.4mm Female	(P)	PE9502	C3	156	Female To Female	(B) (P)	PE9500	B3	158	SMC Plug		PE9318	D3	160
2.4mm Male	(P)	PE9501	A3	156	Female To Female	(PM) (P)	PE9429	C3	158	SSMA Female		PE9352	A4	157
2.92mm Female	(P)	PE9664	A5	155	Female To Female	(B) (H)	PE9006	D3	158	SSMA Male		PE9351	C3	157
2.92mm Male	(P)	PE9662	C4	155	Female To Female	(B) (H)	PE9128	A4	158	TNC Female	(P)	PE9448	D2	159
3.5mm Female	(P)	PE9323	A4	154	Female To Female	(B) (H)	PE9383	B4	158	TNC Female	90°	PE9090	A3	159
3.5mm Male	(P)	PE9324	C3	154	Female To Female	(B) (I)	PE9382	C4	158	TNC Female	(P)	PE9550	B3	159
7/16 DIN Female	(LP)	PE91033	C1	160	Female To Female	(PM)	PE9173	D4	158	TNC Male		PE9446	B2	159
7/16 DIN Female		PE9180	D1	160	Female To Female	90°	PE9359	A5	158	TNC Male		PE9130	C2	159
7/16 DIN Male	(LP)	PE91031	A1	160	Female To Female	(B) 90°	PE9541	B5	158	UHF Female		PE9111	B2	160
7/16 DIN Male		PE9179	B1	160	Male To Female	(P)	PE9426	A1	158	UHF Male		PE9113	A2	160
75 Ohm N Male		PE9350	C4	162	Male To Female	(LP)	PE91040	B1	158	PAL In-Series:				
7mm		PE9216	A2	161	Male To Female	(QD)	PE9311	C1	158	Jack To Jack		PE9681	C1	175
BNC Female	(P)	PE9492	D1	162	Male To Female	(B)	PE9547	D1	158	Plug To Plug		PE9680	B1	175
BNC Female		PE9206	A2	162	Male To Female	(R) (P)	PE9595	A2	158	PAL Jack To:				
BNC Female	(B)	PE9261	B2	162	Male To Female	90°	PE9515	B2	158	F Female		PE9634	D4	177
BNC Female	(B)	PE9540	C2	162	Male To Female	(P)	PE9086	C2	158	F Male		PE9632	B4	177
BNC Female	(PM)	PE9238	D2	162	Male To Male	(LP)	PE91034	B6	157	PAL Plug To:				
BNC Male	(P)	PE9490	D6	161	Male To Male	90°	PE9007	C6	157	F Female		PE9635	C4	177
BNC Male		PE9005	A1	162	Male To Male		PE9198	D6	157	F Male		PE9633	A4	177
BNC Male	(PM)	PE9123	B1	162	T, Female-Female-		PE9101	B6	158	QMA Female To:				
BNC Male	90°	PE9566	C1	162	Female		PE9102	D5	158	N Male		PE9787	B2	161
C Female		PE9539	A4	162	T, Female-Male-					QMA Male To:				
C Male		PE9295	D3	162	Female		PE9481	A6	158	SMA Female		PE9786	B4	151
F Male		PE9389	A5	162	Female		PE9390	C5	158	QN Female To:				
GR874		PE9258	C5	162	T, Male-Female-					N Male		PE9789	C2	161
HN Female		PE9360	B1	161	Female					QN Male To:				
HN Female	(PM)	PE9553	C1	161	Female					N Female		PE9788	D2	161
HN Male		PE9194	A1	161	Female					RCA Jack To:				
LC Female		PE9298	B6	160	Female					BNC Male		PE9171	B4	173
LC Male		PE9237	A6	160	Female					F Female		PE9168	B6	177
MCX Jack		PE9462	D3	161	Female					RCA Plug To:				
MCX Plug		PE9463	C3	161	Female					BNC Female		PE9158	C4	173
Mini UHF Male		PE9183	B3	160	Female					F Female		PE9163	A6	177
QN Male		PE9788	D2	161	Female					Reverse Polarity BNC Female To:				
Reverse Polarity N Male		PE9770	D1	159	Female					BNC Male		PE9530	D4	172
Reverse Polarity SMA Male		PE9732	B4	149	Female					Reverse Polarity BNC Male To:				
Reverse Polarity TNC Male		PE9731	D5	159	Female					BNC Female		PE9529	A5	172
SC Female		PE9292	C5	160	Female					Reverse Polarity MCX Plug To:				
SC Male		PE9277	B5	160	Female					SMA Male		PE9581	C2	152
SMA Female	(P)	PE9432	B2	149	Female					Reverse Polarity N Female To:				
SMA Female	(B) (P)	PE9486	C2	149	Female					N Male		PE9771	C1	159
SMA Female	(PM) (P)	PE9434	D2	149	Female					Reverse Polarity N In-Series:				
SMA Female		PE9083	A3	149	Female					Female To Female		PE9773	B1	159
SMA Female	(B)	PE9408	C3	149	Female					Male To Male		PE9772	A1	159
SMA Female	(B) (P)	PE9435	D3	149	Female					Reverse Polarity N Male To:				
SMA Female	(B)	PE9252	B3	149	Female					N Female		PE9770	D1	159
SMA Female	(PM)	PE9104	A4	149	Female					Reverse Polarity SMA Female To:				
SMA Male	(P)	PE9433	B5	148	Female					N Male		PE9733	C4	149
SMA Male	(B) (P)	PE9487	C5	148	Female					Reverse Polarity TNC Female		PE9606	B4	150
SMA Male	(B) (P)	PE9488	D5	148	Female					Reverse Polarity TNC Male		PE9607	A4	150
SMA Male	(PM) (P)	PE9497	A6	148	Female					SMA Male		PE9534	B5	147
SMA Male		PE9082	B6	148	Female					TNC Female		PE9599	B3	150
SMA Male	(PM)	PE9105	C6	148	Female					TNC Male		PE9598	A3	150
SMB Jack		PE9315	D4	161	Female					Reverse Polarity SMA In-Series:				
SMB Plug		PE9316	C4	161	Female					Female To Female		PE9592	D4	147
SMC Jack		PE9319	C4	160	Female					Female To Female	(B)	PE9593	A5	147
SMC Plug		PE9320	B4	160	Female					Male To Female		PE9591	B4	147
SSMA Female		PE9354	B4	157	Female					Male To Female	90°	PE9594	C4	147
SSMA Male		PE9353	D3	157	Female					Male To Male		PE9590	A4	147
TNC Female	(P)	PE9449	B4	159	Female					Reverse Polarity SMA Male To:				
TNC Female	(PM) (P)	PE9450	C4	159	Female					N Female		PE9732	B4	149
TNC Female		PE9131	D4	159	Female					Reverse Polarity TNC Female		PE9604	D3	150
TNC Female	(B)	PE9482	A5	159	Female									
TNC Female	(PM)	PE9552	B5	159	Female									
					SC Female		PE9196	A5	160					

Adapters

See Our Website For Real-Time Stock Availability!

Feature: (B) Bulkhead Mount / (H) Hermetically Sealed / (I) Isolated Sealed / (P) Precision / (PM) Panel Mount / (PO) Push On / (R) Radius Right Angle / (QD) Quick Disconnect (LP) Low PIM

 Free Freight Available via UPS Ground to USA & Canada	 Real-Time Stock Levels & Pricing On Our Website	 Toll-Free Technical Support (866) 727-8376	 Same-Day Shipping, Even Custom Cable Assemblies	143
--	--	---	--	-----

Adapter Locator

Adapters

See Our Website For Real-Time Stock Availability!

Connector Type	Feature	Model No.	C/R	Page
Reverse Polarity TNC Male		PE9605	C3	150
SMA Female		PE9533	C5	147
TNC Female		PE9596	D2	150
TNC Male		PE9597	C2	150
Reverse Polarity TNC Female To:				
N Male		PE9730	C5	159
Reverse Polarity SMA Female		PE9606	B4	150
Reverse Polarity SMA Male		PE9604	D3	150
SMA Female		PE9603	B2	150
SMA Male		PE9600	D1	150
TNC Male		PE9532	A4	163
Reverse Polarity TNC In-Series:				
Male To Female	90° (P)	PE9918	D3	163
Reverse Polarity TNC Male To:				
N Female		PE9731	D5	159
Reverse Polarity SMA Female		PE9607	A4	150
Reverse Polarity SMA Male		PE9605	C3	150
SMA Female		PE9602	A2	150
SMA Male		PE9601	C1	150
TNC Female		PE9531	B4	163
Reverse Thread SMA Female To:				
SMA Male		PE9682	D5	147
Reverse Thread SMA Male To:				
SMA Female		PE9683	A6	147
SC Female To:				
BNC Female		PE9571	C4	168
N Female		PE9292	C5	160
N Male		PE9196	A5	160
SC In-Series:				
Female To Female		PE9404	A3	168
Female To Female	(B)	PE9573	B3	168
Male To Female		PE9572	C2	168
Male To Female	90°	PE9405	D2	168
Male To Male		PE9403	B2	168
T, Female-Male-Female		PE9225	C3	168
SC Male To:				
BNC Female		PE9200	B4	168
BNC Male		PE9568	A4	168
N Female		PE9277	B5	160
N Male		PE9570	D4	160
SHV In-Series:				
Jack To Jack		PE9337	A4	174
Jack To Jack	(B) (H)	PE9336	B4	174
Plug To Jack		PE9749	C3	174
Plug To Jack	90°	PE9338	D3	174
T, Jack-Plug-Jack		PE9249	C4	174
SHV Jack To:				
MHV Female		PE9339	A3	174
MHV Male		PE9335	C2	174
SHV Plug To:				
MHV Female		PE9265	D2	174
MHV Male		PE9340	B2	174
SMA Female To:				
1.0/2.3 Slide On Jack		PE9693	A5	152
1.0/2.3 Slide On Plug		PE9691	D4	152
1.85mm Female	(P)	PE9729	B3	148
1.85mm Male	(P)	PE9726	A3	148
2.4mm Female	(P)	PE9656	B2	148
2.4mm Male	(P)	PE9655	A2	148
3.5mm Female	(P)	PE9725	B1	148
3.5mm Male	(P)	PE9724	A1	148
7/16 DIN Female	(LP)	PE91042	D5	150
7/16 DIN Male	(LP)	PE91036	B5	150
7/16 DIN Male		PE9412	C5	150
7mm	(P)	PE9214	D3	151
7mm	(PM) (P)	PE9327	A4	151
BNC Female	(P)	PE9496	D6	152
BNC Female		PE9075	A1	153
BNC Female	(B)	PE9185	B1	153
BNC Female	(B)	PE9407	C1	153
BNC Male	(P)	PE9494	B6	152
BNC Male		PE9073	C6	152
D Sub Contact Plug		PE9422	B3	153
D Sub Contact Receptacle		PE9423	C3	153
F Female		PE91002	B2	153

Connector Type	Feature	Model No.	C/R	Page
F Male		PE91001	A2	153
FME Jack		PE9708	B1	151
FME Plug		PE9703	A1	151
GR874		PE9260	A4	153
HN Female		PE9255	B3	151
HN Male		PE9253	A3	151
MCX Jack		PE9470	B2	152
MCX Plug		PE9471	A2	152
MMCX Jack		PE9477	B1	152
MMCX Plug		PE9475	A1	152
N Female	(B)	PE9252	B3	149
N Female	(PM)	PE9104	A4	149
N Female	(P)	PE9432	B2	149
N Female	(B) (P)	PE9486	C2	149
N Female	(PM) (P)	PE9434	D2	149
N Female		PE9083	A3	149
N Female	(B)	PE9408	C3	149
N Female	(B) (P)	PE9435	D3	149
N Male	(P)	PE9430	D6	148
N Male	(P) (PM)	PE9498	A1	149
N Male		PE9081	B1	149
N Male	(QD)	PE9684	C1	149
N Male	(B)	PE9551	D1	149
N Male	(PM)	PE9275	A2	149
QMA Male		PE9786	B4	151
Reverse Polarity SMA Male		PE9533	C5	147
Reverse Polarity TNC Female		PE9603	B2	150
Reverse Polarity TNC Male		PE9602	A2	150
Reverse Thread SMA Male		PE9683	A6	147
SMB Jack		PE9143	C3	152
SMB Plug		PE9142	B3	152
SMC Jack		PE9147	B2	151
SMC Plug		PE9146	A2	151
SMP Female	(P)	PE9779	C5	151
SMP Male	(P)	PE9512	A5	151
SMP Male	(P)	PE9778	B5	151
SSMA Female		PE9399	B4	148
SSMA Male		PE9188	A4	148
SSMB Plug		PE9402	A4	152
TNC Female	(P)	PE9442	C6	149
TNC Female		PE9079	D6	149
TNC Female	(B)	PE9251	A1	150
TNC Female	(PM)	PE9276	B1	150
TNC Male	(P)	PE9440	A6	149
TNC Male	(P)	PE9077	B6	149
UHF Male		PE9415	B6	150
UMCX Jack		PE91006	B6	151
UMCX Plug		PE91005	A6	151
SMA In-Series:				
Female To Female	(P)	PE9507	C5	146
Female To Female	(P)	PE9695	D5	146
Female To Female	(B) (P)	PE9508	A6	146
Female To Female	(P) (PM)	PE9670	B6	146
Female To Female		PE9070	C6	146
Female To Female		PE9380	D6	146
Female To Female	(B)	PE9071	A1	147
Female To Female	(B)	PE9620	B1	147
Female To Female	(B) (H)	PE9184	C1	147
Female To Female	(B) (I)	PE9067	D1	147
Female To Female	(PM)	PE9312	A2	147
Female To Female	(R)	PE9274	B2	147
Female To Female	90°	PE9485	D2	147
Female To Female	90° (P)	PE9643	C2	147
Female-Female-Female		PE9246	D3	147
Female-Male-Female		PE9182	C3	147
Male To Female	(P)	PE9506	D2	146
Male To Female	(P)	PE9694	A3	146
Male To Female	(P) (QD)	PE9774	B3	146
Male To Female	(PM) (P)	PE9671	C3	146
Male To Female		PE9103	D3	146
Male To Female	(QD)	PE9546	A4	146
Male To Female	(B)	PE9621	B4	146
Male To Female	(R)	PE9262	C4	146
Male To Female	90° (P)	PE9641	D4	146
Male To Female	45°	PE9381	B5	146
Male To Female	90°	PE9068	A5	146
Male To Male	(P)	PE9505	B1	146
Male To Male	(P) (PM)	PE9669	C1	146

Connector Type	Feature	Model No.	C/R	Page
Male To Male		PE9069	D1	146
Male To Male	(R)	PE9273	A2	146
Male To Male	90° (P)	PE9642	B2	146
Male To Male		PE9418	C2	146
Male-Female-Male		PE9247	B3	147
Male-Male-Male		PE9379	A3	147
SMA Male To:				
1.0/2.3 Slide On Jack		PE9690	C4	152
1.0/2.3 Slide On Plug		PE9692	B4	152
1.85mm Female	(P)	PE9728	D2	148
1.85mm Male	(P)	PE9727	C2	148
2.4mm Female	(P)	PE9654	D1	148
2.4mm Male	(P)	PE9653	C1	148
3.5mm Female	(P)	PE9723	D6	147
3.5mm Male	(P)	PE9722	C6	147
7/16 DIN Female	(LP)	PE91041	D4	150
7/16 DIN Female		PE9411	A5	150
7/16 DIN Male	(LP)	PE91043	C4	150
7mm	(P)	PE9215	C3	151
BNC Female	(P)	PE9495	D5	152
BNC Female		PE9074	A6	152
BNC Male	(P)	PE9493	B5	152
BNC Male		PE9072	C5	152
D Sub Contact Plug		PE9425	C2	153
D Sub Contact Receptacle		PE9424	D2	153
F Female		PE91003	D1	153
FME Jack		PE9707	D6	150
FME Plug		PE9702	C6	150
GR874		PE9259	D3	153
HN Female		PE9256	D2	151
HN Male		PE9254	C2	151
MCX Jack		PE9472	D1	152
MCX Plug		PE9473	C1	152
MMCX Jack		PE9478	D6	151
MMCX Plug		PE9476	C6	151
N Female	(PM)	PE9105	C6	148
N Female	(P)	PE9433	B5	148
N Female	(B) (P)	PE9487	C5	148
N Female	(B) (P)	PE9488	D5	148
N Female	(PM) (P)	PE9497	A6	148
N Female		PE9082	B6	148
N Male	(P)	PE9431	C4	148
N Male	(PM) (P)	PE9499	D4	148
N Male		PE9080	A5	148
Reverse Polarity MCX Plug		PE9581	C2	152
Reverse Polarity SMA Female		PE9534	B5	147
Reverse Polarity TNC Female		PE9600	D1	150
Reverse Polarity TNC Male		PE9601	C1	150
Reverse Thread SMA Female		PE9682	D5	147
SMB Jack		PE9145	A3	152
SMB Plug		PE9144	D2	152
SMC Jack		PE9149	D1	151
SMC Plug		PE9148	C1	151
SMP Female	(P)	PE9513	D4	151
SMP Male	(P)	PE9511	C4	151
SSMA Female		PE9063	D3	148
SSMA Male		PE9187	C3	148
SSMB Jack		PE9401	D3	152
TNC Female	(P)	PE9441	B5	149
TNC Female		PE9078	C5	149
TNC Female	(PM)	PE9384	D5	149
TNC Male	(P)	PE9439	D4	149
TNC Male		PE9076	A5	149
UHF Female		PE9400	A6	150
UMCX Jack		PE91007	D5	151
SMB In-Series:				
Jack To Jack		PE9116	D2	171
Jack To Jack	(B)	PE9122	A3	171
Plug To Jack		PE9120	C2	171
Plug To Plug		PE9118	B2	171
T, Jack-Jack-Jack		PE9302	A4	171
T, Jack-Plug-Jack		PE9243	C3	171
T, Plug-Jack-Jack		PE9309	D3	171
T, Plug-Plug-Plug		PE9310	B3	171
SMB Jack To:				
BNC Female		PE9136	C5	171
BNC Female	(B)	PE9240	D5	171

Feature: (B) Bulkhead Mount / (H) Hermetically Sealed / (I) Isolated Sealed / (P) Precision / (PM) Panel Mount / (PO) Push On / (R) Radius Right Angle / (QD) Quick Disconnect / (LP) Low PIM

Adapter Locator

Connector Type	Feature	Model No.	C/R	Page
BNC Male		PE9132	B5	171
N Female		PE9315	D4	161
N Male		PE9313	B4	161
SMA Female		PE9143	C3	152
SMA Male		PE9145	A3	152
SMC Jack		PE9283	A4	167
SMC Plug		PE9284	C3	167
SMB Plug To:				
BNC Female		PE9137	D4	171
BNC Female	(B)	PE9241	A5	171
BNC Male		PE9135	C4	171
N Female		PE9316	C4	161
N Male		PE9314	A4	161
SMA Female		PE9142	B3	152
SMA Male		PE9144	D2	152
SMC Jack		PE9282	D3	167
SMC Plug		PE9281	B3	167
SMC In-Series:				
Jack To Jack		PE9115	D1	167
Jack To Jack	(B)	PE9121	A2	167
Plug To Jack		PE9119	B1	167
Plug To Jack	90°	PE9303	C1	167
Plug To Plug		PE9117	A1	167
T, Jack-Jack-Jack		PE9304	D2	167
T, Jack-Plug-Jack		PE9242	C2	167
T, Plug-Plug-Plug		PE9305	B2	167
SMC Jack To:				
BNC Female		PE9140	A5	167
BNC Female	(B)	PE9108	B5	167
BNC Male		PE9138	D4	167
N Female		PE9319	C4	160
N Male		PE9317	A4	160
SMA Female		PE9147	B2	151
SMA Male		PE9149	D1	151
SMB Jack		PE9283	A4	167
SMB Plug		PE9282	D3	167
TNC Male		PE9226	D1	164
SMC Plug To:				
BNC Female		PE9141	C4	167
BNC Male		PE9139	B4	167
N Female		PE9320	B4	160
N Male		PE9318	D3	160
SMA Female		PE9146	A2	151
SMA Male		PE9148	C1	151
SMB Jack		PE9284	C3	167
SMB Plug		PE9281	B3	167
SMP Female To:				
SMA Female	(P)	PE9779	C5	151
SMA Male	(P)	PE9513	D4	151
SMP In-Series:				
Female To Female		PE9686	D6	169
Female To Female		PE9776	B1	170
Female To Female		PE9775	A1	170
Female To Female				
Female To Female		PE91004	C6	169
Female To Female		PE9777	C1	170
SMP Male To:				
SMA Female	(P)	PE9512	A5	151
SMA Female	(P)	PE9778	B5	151
SMA Male	(P)	PE9511	C4	151
SSMA Female To:				
1.85mm Female	(P)	PE9765	B6	156
1.85mm Male	(P)	PE9762	D5	156
2.92mm Female	(P)	PE9769	A4	155
2.92mm Male	(P)	PE9766	C3	155
7mm	(P)	PE9356	D4	157
BNC Male		PE9191	C5	157
N Female		PE9354	B4	157
N Male		PE9352	A4	157
SMA Female		PE9399	B4	148
SMA Male		PE9063	D3	148
SSMA In-Series:				
Female To Female		PE9192	D2	157
Female To Female	(B)	PE9189	A3	157
Male To Female		PE9358	A2	157
Male To Female	(QD)	PE9685	B2	157
Male To Female	90°	PE9334	C2	157
Male To Male		PE9357	D1	157

Connector Type	Feature	Model No.	C/R	Page
SSMA Male To:				
1.85mm Female	(P)	PE9764	A6	156
1.85mm Male	(P)	PE9763	C5	156
2.92mm Female	(P)	PE9768	D3	155
2.92mm Male	(P)	PE9767	B3	155
7mm	(P)	PE9355	C4	157
BNC Female		PE9250	B5	157
BNC Male		PE9213	A5	157
N Female		PE9353	D3	157
N Male		PE9351	C3	157
SMA Female		PE9188	A4	148
SMA Male		PE9187	C3	148
SSMB Jack To:				
BNC Female		PE9394	A1	172
BNC Male		PE9392	D6	171
SMA Male		PE9401	D3	152
SSMB Plug To:				
BNC Female		PE9395	C6	171
BNC Male		PE9393	B6	171
SMA Female		PE9402	A4	152
TNC Female To:				
7/16 DIN Female		PE9639	C5	163
7/16 DIN Male		PE9636	B5	163
7mm	(P)	PE9218	C2	164
BNC Female		PE9097	A5	164
BNC Female	(B) (H)	PE9483	B5	164
BNC Male		PE9098	D4	164
C Male		PE9564	D5	164
FME Jack		PE9714	C1	164
MCX Jack		PE9544	C3	164
MCX Jack	(B)	PE9521	D3	164
MCX Plug		PE9545	B3	164
Mini UHF Male		PE9346	C6	163
N Female	(P)	PE9449	B4	159
N Female	(PM) (P)	PE9450	C4	159
N Female		PE9131	D4	159
N Female	(B)	PE9482	A5	159
N Female	(PM)	PE9552	B5	159
N Female	(P)	PE9448	D2	159
N Male		PE9090	A3	159
N Male	90°	PE9550	B3	159
N Male		PE9599	B3	150
Reverse Polarity SMA Female		PE9596	D2	150
Reverse Polarity SMA Male		PE9531	B4	163
Reverse Polarity TNC Male		PE9442	C6	149
SMA Female	(P)	PE9079	D6	149
SMA Female	(B)	PE9251	A1	150
SMA Female	(PM)	PE9276	B1	150
SMA Male	(P)	PE9441	B5	149
SMA Male		PE9078	C5	149
SMA Male	(PM)	PE9384	D5	149
UHF Male		PE9372	A6	163
TNC In-Series:				
Female To Female	(P)	PE9444	D1	163
Female To Female		PE9099	A2	163
Female To Female	(B) (H)	PE9154	B2	163
Female To Female	(B) (I)	PE9287	C2	163
Female To Female	(PM)	PE9288	D2	163
Female To Female	(P)	PE9443	D6	162
Male To Female	(QD)	PE9561	A1	163
Male To Female	90°	PE9100	B1	163
Male To Female		PE9270	C1	163
Male To Male	(P)	PE9445	A6	162
Male To Male		PE9091	B6	162
Male To Male	90°	PE9560	C6	162
T, Female-Female-Female		PE9289	C3	163
T, Female-Male-Female		PE9195	A3	163
T, Male-Female-Female		PE9290	B3	163
TNC Male To:				
BNC Female	90°	PE9783	C4	164
7/16 DIN Female		PE9638	A5	163
7/16 DIN Male		PE9637	D4	163
7mm	(P)	PE9219	B2	164
BNC Female		PE9088	B4	164
BNC Male		PE9110	A4	164
C Female		PE9562	C5	164

Connector Type	Feature	Model No.	C/R	Page
FME Jack		PE9713	B1	164
FME Plug		PE9699	D6	163
FME Plug	90°	PE9700	A1	164
HN Male		PE9563	A2	164
MCX Jack		PE9542	A3	164
MCX Plug		PE9543	D2	164
Mini UHF Female		PE9345	B6	163
N Female	(P)	PE9447	C3	159
N Female		PE9089	D3	159
N Female	90°	PE9263	A4	159
N Male	(P)	PE9446	B2	159
N Male		PE9130	C2	159
Reverse Polarity SMA Female		PE9598	A3	150
Reverse Polarity SMA Male		PE9597	C2	150
Reverse Polarity TNC Female		PE9532	A4	163
SMA Female	(P)	PE9440	A6	149
SMA Female		PE9077	B6	149
SMA Male	(P)	PE9439	D4	149
SMA Male		PE9076	A5	149
SMC Jack		PE9226	D1	164
UHF Female		PE9291	D5	163
UHF Female To:				
BNC Female		PE9421	B1	166
BNC Male		PE9107	A1	166
F Female		PE9167	D1	166
Mini UHF Male		PE9344	A6	165
N Female		PE9385	D2	160
N Male		PE9111	B2	160
SMA Male		PE9400	A6	150
TNC Male		PE9291	D5	163
UHF In-Series:				
Female To Female		PE9094	D4	165
Female To Female	(B)	PE9114	A5	165
Male To Female	90°	PE9209	C4	165
Male To Male		PE9096	B4	165
T, Female-Male-Female		PE9095	B5	165
UHF Male To:				
BNC Female		PE9004	D6	165
BNC Male		PE9201	C6	165
F Female		PE9165	C1	166
FME Plug		PE9701	B6	165
Mini UHF Female		PE9348	D5	165
N Female		PE9112	C2	160
N Male		PE9113	A2	160
SMA Female		PE9415	B6	150
TNC Female		PE9372	A6	163
UMCX Jack To:				
SMA Female		PE91006	B6	151
SMA Male		PE91007	D5	151
UMCX Plug To:				
SMA Female		PE91005	A6	151

In 1941, the term RADAR was coined by the United States Navy as an acronym for Radio Detection And Ranging.

Adapters

See Our Website For Real-Time Stock Availability!

Feature: (B) Bulkhead Mount / (H) Hermetically Sealed / (I) Isolated Sealed / (P) Precision / (PM) Panel Mount / (PO) Push On / (R) Radius Right Angle / (QD) Quick Disconnect / (LP) Low PIM

 <p>Free Freight Available via UPS Ground to USA & Canada</p>	 <p>Real-Time Stock Levels & Pricing On Our WebSite</p>	 <p>Toil-Free Technical Support (866) 727-8376</p>	 <p>Same-Day Shipping, Even Custom Cable Assemblies</p>
--	--	---	--

ADAPTERS

See Adapter Locator on Pages 140-145 or the Adapter Matrix on Pages 138-139

See Page 246 for Mounting Holes

Adapters



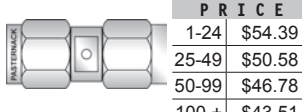
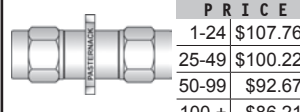
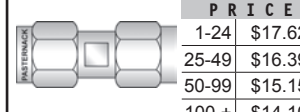
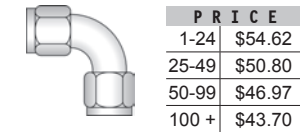
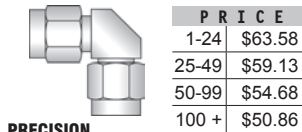
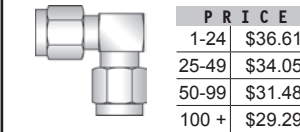
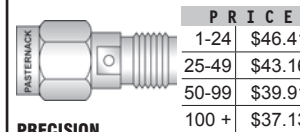
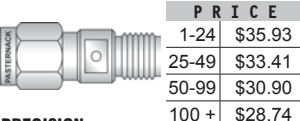
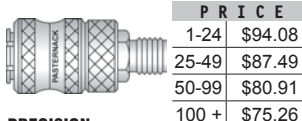
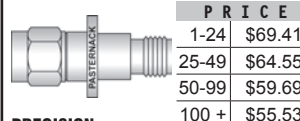
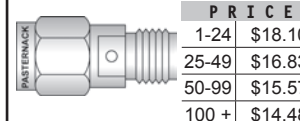
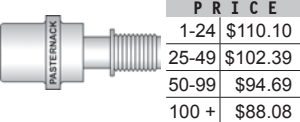
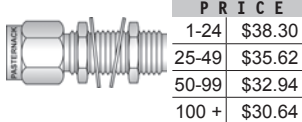
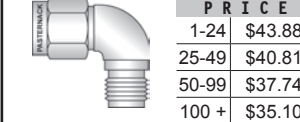
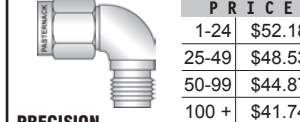
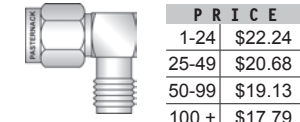
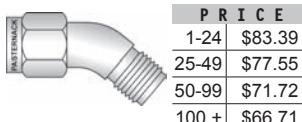
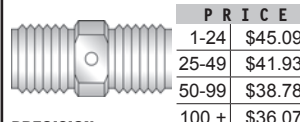
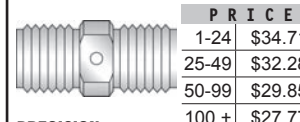
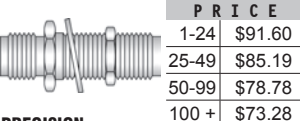
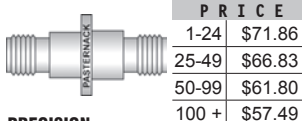
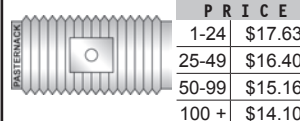
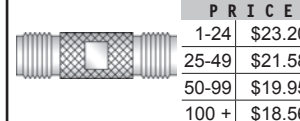







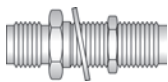
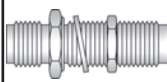







See Our Website For Real-Time Stock Availability!

	A	B	C	D																																								
1	 <p>SMA In-Series</p>	 <table border="1"> <thead> <tr> <th colspan="2">PRICE</th> </tr> </thead> <tbody> <tr> <td>1-24</td> <td>\$54.39</td> </tr> <tr> <td>25-49</td> <td>\$50.58</td> </tr> <tr> <td>50-99</td> <td>\$46.78</td> </tr> <tr> <td>100 +</td> <td>\$43.51</td> </tr> </tbody> </table> <p>PRECISION</p> <p>Model No: PE9505</p> <p>SMA Male To SMA Male Max VSWR 1.15:1 @ 18 GHz 1.20:1 @ 26.5 GHz</p>	PRICE		1-24	\$54.39	25-49	\$50.58	50-99	\$46.78	100 +	\$43.51	 <table border="1"> <thead> <tr> <th colspan="2">PRICE</th> </tr> </thead> <tbody> <tr> <td>1-24</td> <td>\$107.76</td> </tr> <tr> <td>25-49</td> <td>\$100.22</td> </tr> <tr> <td>50-99</td> <td>\$92.67</td> </tr> <tr> <td>100 +</td> <td>\$86.21</td> </tr> </tbody> </table> <p>PRECISION</p> <p>Model No: PE9669</p> <p>SMA Male To SMA Male 4 Hole Panel Mount Mounting Hole A01 Max VSWR 1.25:1 @ 18 GHz</p>	PRICE		1-24	\$107.76	25-49	\$100.22	50-99	\$92.67	100 +	\$86.21	 <table border="1"> <thead> <tr> <th colspan="2">PRICE</th> </tr> </thead> <tbody> <tr> <td>1-24</td> <td>\$17.62</td> </tr> <tr> <td>25-49</td> <td>\$16.39</td> </tr> <tr> <td>50-99</td> <td>\$15.15</td> </tr> <tr> <td>100 +</td> <td>\$14.10</td> </tr> </tbody> </table> <p>Model No: PE9069</p> <p>SMA Male To SMA Male</p>	PRICE		1-24	\$17.62	25-49	\$16.39	50-99	\$15.15	100 +	\$14.10										
PRICE																																												
1-24	\$54.39																																											
25-49	\$50.58																																											
50-99	\$46.78																																											
100 +	\$43.51																																											
PRICE																																												
1-24	\$107.76																																											
25-49	\$100.22																																											
50-99	\$92.67																																											
100 +	\$86.21																																											
PRICE																																												
1-24	\$17.62																																											
25-49	\$16.39																																											
50-99	\$15.15																																											
100 +	\$14.10																																											
2	 <table border="1"> <thead> <tr> <th colspan="2">PRICE</th> </tr> </thead> <tbody> <tr> <td>1-24</td> <td>\$54.62</td> </tr> <tr> <td>25-49</td> <td>\$50.80</td> </tr> <tr> <td>50-99</td> <td>\$46.97</td> </tr> <tr> <td>100 +</td> <td>\$43.70</td> </tr> </tbody> </table> <p>Model No: PE9273</p> <p>SMA Male To SMA Male Radius Right Angle</p>	PRICE		1-24	\$54.62	25-49	\$50.80	50-99	\$46.97	100 +	\$43.70	 <table border="1"> <thead> <tr> <th colspan="2">PRICE</th> </tr> </thead> <tbody> <tr> <td>1-24</td> <td>\$63.58</td> </tr> <tr> <td>25-49</td> <td>\$59.13</td> </tr> <tr> <td>50-99</td> <td>\$54.68</td> </tr> <tr> <td>100 +</td> <td>\$50.86</td> </tr> </tbody> </table> <p>PRECISION</p> <p>Model No: PE9642</p> <p>SMA Male To SMA Male Right Angle Max VSWR 1.35:1 @ 27 GHz</p>	PRICE		1-24	\$63.58	25-49	\$59.13	50-99	\$54.68	100 +	\$50.86	 <table border="1"> <thead> <tr> <th colspan="2">PRICE</th> </tr> </thead> <tbody> <tr> <td>1-24</td> <td>\$36.61</td> </tr> <tr> <td>25-49</td> <td>\$34.05</td> </tr> <tr> <td>50-99</td> <td>\$31.48</td> </tr> <tr> <td>100 +</td> <td>\$29.29</td> </tr> </tbody> </table> <p>Model No: PE9418</p> <p>SMA Male To SMA Male Right Angle</p>	PRICE		1-24	\$36.61	25-49	\$34.05	50-99	\$31.48	100 +	\$29.29	 <table border="1"> <thead> <tr> <th colspan="2">PRICE</th> </tr> </thead> <tbody> <tr> <td>1-24</td> <td>\$46.41</td> </tr> <tr> <td>25-49</td> <td>\$43.16</td> </tr> <tr> <td>50-99</td> <td>\$39.91</td> </tr> <tr> <td>100 +</td> <td>\$37.13</td> </tr> </tbody> </table> <p>PRECISION</p> <p>Model No: PE9506</p> <p>SMA Male To SMA Female Max VSWR 1.15:1 @ 18 GHz 1.20:1 @ 26.5 GHz</p>	PRICE		1-24	\$46.41	25-49	\$43.16	50-99	\$39.91	100 +	\$37.13
PRICE																																												
1-24	\$54.62																																											
25-49	\$50.80																																											
50-99	\$46.97																																											
100 +	\$43.70																																											
PRICE																																												
1-24	\$63.58																																											
25-49	\$59.13																																											
50-99	\$54.68																																											
100 +	\$50.86																																											
PRICE																																												
1-24	\$36.61																																											
25-49	\$34.05																																											
50-99	\$31.48																																											
100 +	\$29.29																																											
PRICE																																												
1-24	\$46.41																																											
25-49	\$43.16																																											
50-99	\$39.91																																											
100 +	\$37.13																																											
3	 <table border="1"> <thead> <tr> <th colspan="2">PRICE</th> </tr> </thead> <tbody> <tr> <td>1-24</td> <td>\$35.93</td> </tr> <tr> <td>25-49</td> <td>\$33.41</td> </tr> <tr> <td>50-99</td> <td>\$30.90</td> </tr> <tr> <td>100 +</td> <td>\$28.74</td> </tr> </tbody> </table> <p>PRECISION</p> <p>Model No: PE9694</p> <p>SMA Male To SMA Female Max VSWR 1.15:1 @ 18 GHz</p>	PRICE		1-24	\$35.93	25-49	\$33.41	50-99	\$30.90	100 +	\$28.74	 <table border="1"> <thead> <tr> <th colspan="2">PRICE</th> </tr> </thead> <tbody> <tr> <td>1-24</td> <td>\$94.08</td> </tr> <tr> <td>25-49</td> <td>\$87.49</td> </tr> <tr> <td>50-99</td> <td>\$80.91</td> </tr> <tr> <td>100 +</td> <td>\$75.26</td> </tr> </tbody> </table> <p>PRECISION</p> <p>Model No: PE9774</p> <p>SMA Male Quick-Disconnect To SMA Female Max VSWR 1.15:1 @ 18 GHz</p>	PRICE		1-24	\$94.08	25-49	\$87.49	50-99	\$80.91	100 +	\$75.26	 <table border="1"> <thead> <tr> <th colspan="2">PRICE</th> </tr> </thead> <tbody> <tr> <td>1-24</td> <td>\$69.41</td> </tr> <tr> <td>25-49</td> <td>\$64.55</td> </tr> <tr> <td>50-99</td> <td>\$59.69</td> </tr> <tr> <td>100 +</td> <td>\$55.53</td> </tr> </tbody> </table> <p>PRECISION</p> <p>Model No: PE9671</p> <p>SMA Male To SMA Female 4 Hole Panel Mount Mounting Hole A01 Max VSWR 1.25:1 @ 18 GHz</p>	PRICE		1-24	\$69.41	25-49	\$64.55	50-99	\$59.69	100 +	\$55.53	 <table border="1"> <thead> <tr> <th colspan="2">PRICE</th> </tr> </thead> <tbody> <tr> <td>1-24</td> <td>\$18.10</td> </tr> <tr> <td>25-49</td> <td>\$16.83</td> </tr> <tr> <td>50-99</td> <td>\$15.57</td> </tr> <tr> <td>100 +</td> <td>\$14.48</td> </tr> </tbody> </table> <p>Model No: PE9103</p> <p>SMA Male To SMA Female</p>	PRICE		1-24	\$18.10	25-49	\$16.83	50-99	\$15.57	100 +	\$14.48
PRICE																																												
1-24	\$35.93																																											
25-49	\$33.41																																											
50-99	\$30.90																																											
100 +	\$28.74																																											
PRICE																																												
1-24	\$94.08																																											
25-49	\$87.49																																											
50-99	\$80.91																																											
100 +	\$75.26																																											
PRICE																																												
1-24	\$69.41																																											
25-49	\$64.55																																											
50-99	\$59.69																																											
100 +	\$55.53																																											
PRICE																																												
1-24	\$18.10																																											
25-49	\$16.83																																											
50-99	\$15.57																																											
100 +	\$14.48																																											
4	 <table border="1"> <thead> <tr> <th colspan="2">PRICE</th> </tr> </thead> <tbody> <tr> <td>1-24</td> <td>\$110.10</td> </tr> <tr> <td>25-49</td> <td>\$102.39</td> </tr> <tr> <td>50-99</td> <td>\$94.69</td> </tr> <tr> <td>100 +</td> <td>\$88.08</td> </tr> </tbody> </table> <p>Model No: PE9546</p> <p>SMA Male Quick Disconnect To SMA Female</p>	PRICE		1-24	\$110.10	25-49	\$102.39	50-99	\$94.69	100 +	\$88.08	 <table border="1"> <thead> <tr> <th colspan="2">PRICE</th> </tr> </thead> <tbody> <tr> <td>1-24</td> <td>\$38.30</td> </tr> <tr> <td>25-49</td> <td>\$35.62</td> </tr> <tr> <td>50-99</td> <td>\$32.94</td> </tr> <tr> <td>100 +</td> <td>\$30.64</td> </tr> </tbody> </table> <p>Model No: PE9621</p> <p>SMA Male To SMA Female Bulkhead Mounting Hole B02</p>	PRICE		1-24	\$38.30	25-49	\$35.62	50-99	\$32.94	100 +	\$30.64	 <table border="1"> <thead> <tr> <th colspan="2">PRICE</th> </tr> </thead> <tbody> <tr> <td>1-24</td> <td>\$43.88</td> </tr> <tr> <td>25-49</td> <td>\$40.81</td> </tr> <tr> <td>50-99</td> <td>\$37.74</td> </tr> <tr> <td>100 +</td> <td>\$35.10</td> </tr> </tbody> </table> <p>Model No: PE9262</p> <p>SMA Male To SMA Female Radius Right Angle</p>	PRICE		1-24	\$43.88	25-49	\$40.81	50-99	\$37.74	100 +	\$35.10	 <table border="1"> <thead> <tr> <th colspan="2">PRICE</th> </tr> </thead> <tbody> <tr> <td>1-24</td> <td>\$52.18</td> </tr> <tr> <td>25-49</td> <td>\$48.53</td> </tr> <tr> <td>50-99</td> <td>\$44.87</td> </tr> <tr> <td>100 +</td> <td>\$41.74</td> </tr> </tbody> </table> <p>PRECISION</p> <p>Model No: PE9641</p> <p>SMA Male To SMA Female Right Angle Max VSWR 1.35:1 @ 27 GHz</p>	PRICE		1-24	\$52.18	25-49	\$48.53	50-99	\$44.87	100 +	\$41.74
PRICE																																												
1-24	\$110.10																																											
25-49	\$102.39																																											
50-99	\$94.69																																											
100 +	\$88.08																																											
PRICE																																												
1-24	\$38.30																																											
25-49	\$35.62																																											
50-99	\$32.94																																											
100 +	\$30.64																																											
PRICE																																												
1-24	\$43.88																																											
25-49	\$40.81																																											
50-99	\$37.74																																											
100 +	\$35.10																																											
PRICE																																												
1-24	\$52.18																																											
25-49	\$48.53																																											
50-99	\$44.87																																											
100 +	\$41.74																																											
5	 <table border="1"> <thead> <tr> <th colspan="2">PRICE</th> </tr> </thead> <tbody> <tr> <td>1-24</td> <td>\$22.24</td> </tr> <tr> <td>25-49</td> <td>\$20.68</td> </tr> <tr> <td>50-99</td> <td>\$19.13</td> </tr> <tr> <td>100 +</td> <td>\$17.79</td> </tr> </tbody> </table> <p>Model No: PE9068</p> <p>SMA Male To SMA Female Right Angle</p>	PRICE		1-24	\$22.24	25-49	\$20.68	50-99	\$19.13	100 +	\$17.79	 <table border="1"> <thead> <tr> <th colspan="2">PRICE</th> </tr> </thead> <tbody> <tr> <td>1-24</td> <td>\$83.39</td> </tr> <tr> <td>25-49</td> <td>\$77.55</td> </tr> <tr> <td>50-99</td> <td>\$71.72</td> </tr> <tr> <td>100 +</td> <td>\$66.71</td> </tr> </tbody> </table> <p>Model No: PE9381</p> <p>SMA Male To SMA Female 45 Degree Angle</p>	PRICE		1-24	\$83.39	25-49	\$77.55	50-99	\$71.72	100 +	\$66.71	 <table border="1"> <thead> <tr> <th colspan="2">PRICE</th> </tr> </thead> <tbody> <tr> <td>1-24</td> <td>\$45.09</td> </tr> <tr> <td>25-49</td> <td>\$41.93</td> </tr> <tr> <td>50-99</td> <td>\$38.78</td> </tr> <tr> <td>100 +</td> <td>\$36.07</td> </tr> </tbody> </table> <p>PRECISION</p> <p>Model No: PE9507</p> <p>SMA Female To SMA Female Max VSWR 1.15:1 @ 18 GHz 1.20:1 @ 26.5 GHz</p>	PRICE		1-24	\$45.09	25-49	\$41.93	50-99	\$38.78	100 +	\$36.07	 <table border="1"> <thead> <tr> <th colspan="2">PRICE</th> </tr> </thead> <tbody> <tr> <td>1-24</td> <td>\$34.71</td> </tr> <tr> <td>25-49</td> <td>\$32.28</td> </tr> <tr> <td>50-99</td> <td>\$29.85</td> </tr> <tr> <td>100 +</td> <td>\$27.77</td> </tr> </tbody> </table> <p>PRECISION</p> <p>Model No: PE9695</p> <p>SMA Female To SMA Female Max VSWR 1.15:1 @ 18 GHz</p>	PRICE		1-24	\$34.71	25-49	\$32.28	50-99	\$29.85	100 +	\$27.77
PRICE																																												
1-24	\$22.24																																											
25-49	\$20.68																																											
50-99	\$19.13																																											
100 +	\$17.79																																											
PRICE																																												
1-24	\$83.39																																											
25-49	\$77.55																																											
50-99	\$71.72																																											
100 +	\$66.71																																											
PRICE																																												
1-24	\$45.09																																											
25-49	\$41.93																																											
50-99	\$38.78																																											
100 +	\$36.07																																											
PRICE																																												
1-24	\$34.71																																											
25-49	\$32.28																																											
50-99	\$29.85																																											
100 +	\$27.77																																											
6	 <table border="1"> <thead> <tr> <th colspan="2">PRICE</th> </tr> </thead> <tbody> <tr> <td>1-24</td> <td>\$91.60</td> </tr> <tr> <td>25-49</td> <td>\$85.19</td> </tr> <tr> <td>50-99</td> <td>\$78.78</td> </tr> <tr> <td>100 +</td> <td>\$73.28</td> </tr> </tbody> </table> <p>PRECISION</p> <p>Model No: PE9508</p> <p>SMA Female To SMA Female Bulkhead, Mounting Hole B02 Max VSWR 1.15:1 @ 18 GHz 1.30:1 @ 26.5 GHz</p>	PRICE		1-24	\$91.60	25-49	\$85.19	50-99	\$78.78	100 +	\$73.28	 <table border="1"> <thead> <tr> <th colspan="2">PRICE</th> </tr> </thead> <tbody> <tr> <td>1-24</td> <td>\$71.86</td> </tr> <tr> <td>25-49</td> <td>\$66.83</td> </tr> <tr> <td>50-99</td> <td>\$61.80</td> </tr> <tr> <td>100 +</td> <td>\$57.49</td> </tr> </tbody> </table> <p>PRECISION</p> <p>Model No: PE9670</p> <p>SMA Female To SMA Female 4 Hole Panel Mount Mounting Hole A01 Max VSWR 1.25:1 @ 18 GHz</p>	PRICE		1-24	\$71.86	25-49	\$66.83	50-99	\$61.80	100 +	\$57.49	 <table border="1"> <thead> <tr> <th colspan="2">PRICE</th> </tr> </thead> <tbody> <tr> <td>1-24</td> <td>\$17.63</td> </tr> <tr> <td>25-49</td> <td>\$16.40</td> </tr> <tr> <td>50-99</td> <td>\$15.16</td> </tr> <tr> <td>100 +</td> <td>\$14.10</td> </tr> </tbody> </table> <p>Model No: PE9070</p> <p>SMA Female To SMA Female</p>	PRICE		1-24	\$17.63	25-49	\$16.40	50-99	\$15.16	100 +	\$14.10	 <table border="1"> <thead> <tr> <th colspan="2">PRICE</th> </tr> </thead> <tbody> <tr> <td>1-24</td> <td>\$23.20</td> </tr> <tr> <td>25-49</td> <td>\$21.58</td> </tr> <tr> <td>50-99</td> <td>\$19.95</td> </tr> <tr> <td>100 +</td> <td>\$18.56</td> </tr> </tbody> </table> <p>Model No: PE9380</p> <p>SMA Female To SMA Female With Knurl</p>	PRICE		1-24	\$23.20	25-49	\$21.58	50-99	\$19.95	100 +	\$18.56
PRICE																																												
1-24	\$91.60																																											
25-49	\$85.19																																											
50-99	\$78.78																																											
100 +	\$73.28																																											
PRICE																																												
1-24	\$71.86																																											
25-49	\$66.83																																											
50-99	\$61.80																																											
100 +	\$57.49																																											
PRICE																																												
1-24	\$17.63																																											
25-49	\$16.40																																											
50-99	\$15.16																																											
100 +	\$14.10																																											
PRICE																																												
1-24	\$23.20																																											
25-49	\$21.58																																											
50-99	\$19.95																																											
100 +	\$18.56																																											

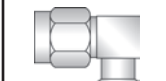
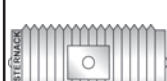
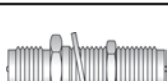
ADAPTERS

See Adapter Locator on Pages 140-145 or the Adapter Matrix on Pages 138-139

See Page 246 for Mounting Holes

	A	B	C	D																																								
1	 <table border="1"> <thead> <tr> <th colspan="2">PRICE</th> </tr> </thead> <tbody> <tr> <td>1-24</td> <td>\$23.15</td> </tr> <tr> <td>25-49</td> <td>\$21.53</td> </tr> <tr> <td>50-99</td> <td>\$19.91</td> </tr> <tr> <td>100 +</td> <td>\$18.52</td> </tr> </tbody> </table> <p>Model No: PE9071 SMA Female To SMA Female Bulkhead Mounting Hole B02</p>	PRICE		1-24	\$23.15	25-49	\$21.53	50-99	\$19.91	100 +	\$18.52	 <table border="1"> <thead> <tr> <th colspan="2">PRICE</th> </tr> </thead> <tbody> <tr> <td>1-24</td> <td>\$25.38</td> </tr> <tr> <td>25-49</td> <td>\$23.60</td> </tr> <tr> <td>50-99</td> <td>\$21.83</td> </tr> <tr> <td>100 +</td> <td>\$20.30</td> </tr> </tbody> </table> <p>Model No: PE9620 SMA Female To SMA Female Bulkhead With O-Ring Mounting Hole B02</p>	PRICE		1-24	\$25.38	25-49	\$23.60	50-99	\$21.83	100 +	\$20.30	 <table border="1"> <thead> <tr> <th colspan="2">PRICE</th> </tr> </thead> <tbody> <tr> <td>1-24</td> <td>\$34.35</td> </tr> <tr> <td>25-49</td> <td>\$31.95</td> </tr> <tr> <td>50-99</td> <td>\$29.54</td> </tr> <tr> <td>100 +</td> <td>\$27.48</td> </tr> </tbody> </table> <p>Model No: PE9184 SMA Female To SMA Female Bulkhead, Hermetically Sealed Mounting Hole B03</p>	PRICE		1-24	\$34.35	25-49	\$31.95	50-99	\$29.54	100 +	\$27.48	 <table border="1"> <thead> <tr> <th colspan="2">PRICE</th> </tr> </thead> <tbody> <tr> <td>1-24</td> <td>\$28.07</td> </tr> <tr> <td>25-49</td> <td>\$26.11</td> </tr> <tr> <td>50-99</td> <td>\$24.14</td> </tr> <tr> <td>100 +</td> <td>\$22.46</td> </tr> </tbody> </table> <p>Model No: PE9067 SMA Female To SMA Female Bulkhead, Isolated Ground Mounting Hole B03</p>	PRICE		1-24	\$28.07	25-49	\$26.11	50-99	\$24.14	100 +	\$22.46
	PRICE																																											
1-24	\$23.15																																											
25-49	\$21.53																																											
50-99	\$19.91																																											
100 +	\$18.52																																											
PRICE																																												
1-24	\$25.38																																											
25-49	\$23.60																																											
50-99	\$21.83																																											
100 +	\$20.30																																											
PRICE																																												
1-24	\$34.35																																											
25-49	\$31.95																																											
50-99	\$29.54																																											
100 +	\$27.48																																											
PRICE																																												
1-24	\$28.07																																											
25-49	\$26.11																																											
50-99	\$24.14																																											
100 +	\$22.46																																											
2	 <table border="1"> <thead> <tr> <th colspan="2">PRICE</th> </tr> </thead> <tbody> <tr> <td>1-24</td> <td>\$47.94</td> </tr> <tr> <td>25-49</td> <td>\$44.58</td> </tr> <tr> <td>50-99</td> <td>\$41.23</td> </tr> <tr> <td>100 +</td> <td>\$38.35</td> </tr> </tbody> </table> <p>Model No: PE9312 SMA Female To SMA Female Panel Mount Mounting Hole A01</p>	PRICE		1-24	\$47.94	25-49	\$44.58	50-99	\$41.23	100 +	\$38.35	 <table border="1"> <thead> <tr> <th colspan="2">PRICE</th> </tr> </thead> <tbody> <tr> <td>1-24</td> <td>\$69.41</td> </tr> <tr> <td>25-49</td> <td>\$64.55</td> </tr> <tr> <td>50-99</td> <td>\$59.69</td> </tr> <tr> <td>100 +</td> <td>\$55.53</td> </tr> </tbody> </table> <p>Model No: PE9274 SMA Female To SMA Female Radius Right Angle</p>	PRICE		1-24	\$69.41	25-49	\$64.55	50-99	\$59.69	100 +	\$55.53	 <table border="1"> <thead> <tr> <th colspan="2">PRICE</th> </tr> </thead> <tbody> <tr> <td>1-24</td> <td>\$69.41</td> </tr> <tr> <td>25-49</td> <td>\$64.55</td> </tr> <tr> <td>50-99</td> <td>\$59.69</td> </tr> <tr> <td>100 +</td> <td>\$55.53</td> </tr> </tbody> </table> <p>PRECISION Model No: PE9643 SMA Female To SMA Female Right Angle Max VSWR 1.35:1 @ 27 GHz</p>	PRICE		1-24	\$69.41	25-49	\$64.55	50-99	\$59.69	100 +	\$55.53	 <table border="1"> <thead> <tr> <th colspan="2">PRICE</th> </tr> </thead> <tbody> <tr> <td>1-24</td> <td>\$33.79</td> </tr> <tr> <td>25-49</td> <td>\$31.42</td> </tr> <tr> <td>50-99</td> <td>\$29.06</td> </tr> <tr> <td>100 +</td> <td>\$27.03</td> </tr> </tbody> </table> <p>Model No: PE9485 SMA Female To SMA Female Right Angle</p>	PRICE		1-24	\$33.79	25-49	\$31.42	50-99	\$29.06	100 +	\$27.03
	PRICE																																											
1-24	\$47.94																																											
25-49	\$44.58																																											
50-99	\$41.23																																											
100 +	\$38.35																																											
PRICE																																												
1-24	\$69.41																																											
25-49	\$64.55																																											
50-99	\$59.69																																											
100 +	\$55.53																																											
PRICE																																												
1-24	\$69.41																																											
25-49	\$64.55																																											
50-99	\$59.69																																											
100 +	\$55.53																																											
PRICE																																												
1-24	\$33.79																																											
25-49	\$31.42																																											
50-99	\$29.06																																											
100 +	\$27.03																																											
3	 <table border="1"> <thead> <tr> <th colspan="2">PRICE</th> </tr> </thead> <tbody> <tr> <td>1-24</td> <td>\$52.69</td> </tr> <tr> <td>25-49</td> <td>\$49.00</td> </tr> <tr> <td>50-99</td> <td>\$45.31</td> </tr> <tr> <td>100 +</td> <td>\$42.15</td> </tr> </tbody> </table> <p>Model No: PE9379 SMA "T" Male-Male-Male</p>	PRICE		1-24	\$52.69	25-49	\$49.00	50-99	\$45.31	100 +	\$42.15	 <table border="1"> <thead> <tr> <th colspan="2">PRICE</th> </tr> </thead> <tbody> <tr> <td>1-24</td> <td>\$57.81</td> </tr> <tr> <td>25-49</td> <td>\$53.76</td> </tr> <tr> <td>50-99</td> <td>\$49.72</td> </tr> <tr> <td>100 +</td> <td>\$46.25</td> </tr> </tbody> </table> <p>Model No: PE9247 SMA "T" Male-Female-Male</p>	PRICE		1-24	\$57.81	25-49	\$53.76	50-99	\$49.72	100 +	\$46.25	 <table border="1"> <thead> <tr> <th colspan="2">PRICE</th> </tr> </thead> <tbody> <tr> <td>1-24</td> <td>\$37.64</td> </tr> <tr> <td>25-49</td> <td>\$35.01</td> </tr> <tr> <td>50-99</td> <td>\$32.37</td> </tr> <tr> <td>100 +</td> <td>\$30.11</td> </tr> </tbody> </table> <p>Model No: PE9182 SMA "T" Female-Male-Female</p>	PRICE		1-24	\$37.64	25-49	\$35.01	50-99	\$32.37	100 +	\$30.11	 <table border="1"> <thead> <tr> <th colspan="2">PRICE</th> </tr> </thead> <tbody> <tr> <td>1-24</td> <td>\$48.79</td> </tr> <tr> <td>25-49</td> <td>\$45.37</td> </tr> <tr> <td>50-99</td> <td>\$41.96</td> </tr> <tr> <td>100 +</td> <td>\$39.03</td> </tr> </tbody> </table> <p>Model No: PE9246 SMA "T" Female-Female-Female</p>	PRICE		1-24	\$48.79	25-49	\$45.37	50-99	\$41.96	100 +	\$39.03
	PRICE																																											
1-24	\$52.69																																											
25-49	\$49.00																																											
50-99	\$45.31																																											
100 +	\$42.15																																											
PRICE																																												
1-24	\$57.81																																											
25-49	\$53.76																																											
50-99	\$49.72																																											
100 +	\$46.25																																											
PRICE																																												
1-24	\$37.64																																											
25-49	\$35.01																																											
50-99	\$32.37																																											
100 +	\$30.11																																											
PRICE																																												
1-24	\$48.79																																											
25-49	\$45.37																																											
50-99	\$41.96																																											
100 +	\$39.03																																											
4	 <table border="1"> <thead> <tr> <th colspan="2">PRICE</th> </tr> </thead> <tbody> <tr> <td>1-24</td> <td>\$35.26</td> </tr> <tr> <td>25-49</td> <td>\$32.79</td> </tr> <tr> <td>50-99</td> <td>\$30.32</td> </tr> <tr> <td>100 +</td> <td>\$28.21</td> </tr> </tbody> </table> <p>Model No: PE9590 Reverse Polarity SMA Male To Reverse Polarity SMA Male</p>	PRICE		1-24	\$35.26	25-49	\$32.79	50-99	\$30.32	100 +	\$28.21	 <table border="1"> <thead> <tr> <th colspan="2">PRICE</th> </tr> </thead> <tbody> <tr> <td>1-24</td> <td>\$35.26</td> </tr> <tr> <td>25-49</td> <td>\$32.79</td> </tr> <tr> <td>50-99</td> <td>\$30.32</td> </tr> <tr> <td>100 +</td> <td>\$28.21</td> </tr> </tbody> </table> <p>Model No: PE9591 Reverse Polarity SMA Male To Reverse Polarity SMA Female</p>	PRICE		1-24	\$35.26	25-49	\$32.79	50-99	\$30.32	100 +	\$28.21	 <table border="1"> <thead> <tr> <th colspan="2">PRICE</th> </tr> </thead> <tbody> <tr> <td>1-24</td> <td>\$25.89</td> </tr> <tr> <td>25-49</td> <td>\$24.08</td> </tr> <tr> <td>50-99</td> <td>\$22.27</td> </tr> <tr> <td>100 +</td> <td>\$20.71</td> </tr> </tbody> </table> <p>Model No: PE9594 Reverse Polarity SMA Male To Reverse Polarity SMA Female Right Angle</p>	PRICE		1-24	\$25.89	25-49	\$24.08	50-99	\$22.27	100 +	\$20.71	 <table border="1"> <thead> <tr> <th colspan="2">PRICE</th> </tr> </thead> <tbody> <tr> <td>1-24</td> <td>\$20.87</td> </tr> <tr> <td>25-49</td> <td>\$19.41</td> </tr> <tr> <td>50-99</td> <td>\$17.95</td> </tr> <tr> <td>100 +</td> <td>\$16.70</td> </tr> </tbody> </table> <p>Model No: PE9592 Reverse Polarity SMA Female To Reverse Polarity SMA Female</p>	PRICE		1-24	\$20.87	25-49	\$19.41	50-99	\$17.95	100 +	\$16.70
	PRICE																																											
1-24	\$35.26																																											
25-49	\$32.79																																											
50-99	\$30.32																																											
100 +	\$28.21																																											
PRICE																																												
1-24	\$35.26																																											
25-49	\$32.79																																											
50-99	\$30.32																																											
100 +	\$28.21																																											
PRICE																																												
1-24	\$25.89																																											
25-49	\$24.08																																											
50-99	\$22.27																																											
100 +	\$20.71																																											
PRICE																																												
1-24	\$20.87																																											
25-49	\$19.41																																											
50-99	\$17.95																																											
100 +	\$16.70																																											
5	 <table border="1"> <thead> <tr> <th colspan="2">PRICE</th> </tr> </thead> <tbody> <tr> <td>1-24</td> <td>\$34.71</td> </tr> <tr> <td>25-49</td> <td>\$32.28</td> </tr> <tr> <td>50-99</td> <td>\$29.85</td> </tr> <tr> <td>100 +</td> <td>\$27.77</td> </tr> </tbody> </table> <p>Model No: PE9593 Reverse Polarity SMA Female To Reverse Polarity SMA Female Bulkhead Mounting Hole B02</p>	PRICE		1-24	\$34.71	25-49	\$32.28	50-99	\$29.85	100 +	\$27.77	 <table border="1"> <thead> <tr> <th colspan="2">PRICE</th> </tr> </thead> <tbody> <tr> <td>1-24</td> <td>\$32.88</td> </tr> <tr> <td>25-49</td> <td>\$30.58</td> </tr> <tr> <td>50-99</td> <td>\$28.28</td> </tr> <tr> <td>100 +</td> <td>\$26.30</td> </tr> </tbody> </table> <p>Model No: PE9534 Standard SMA Male To Reverse Polarity SMA Female</p>	PRICE		1-24	\$32.88	25-49	\$30.58	50-99	\$28.28	100 +	\$26.30	 <table border="1"> <thead> <tr> <th colspan="2">PRICE</th> </tr> </thead> <tbody> <tr> <td>1-24</td> <td>\$23.36</td> </tr> <tr> <td>25-49</td> <td>\$21.72</td> </tr> <tr> <td>50-99</td> <td>\$20.09</td> </tr> <tr> <td>100 +</td> <td>\$18.69</td> </tr> </tbody> </table> <p>Model No: PE9533 Standard SMA Female To Reverse Polarity SMA Male</p>	PRICE		1-24	\$23.36	25-49	\$21.72	50-99	\$20.09	100 +	\$18.69	 <table border="1"> <thead> <tr> <th colspan="2">PRICE</th> </tr> </thead> <tbody> <tr> <td>1-24</td> <td>\$35.26</td> </tr> <tr> <td>25-49</td> <td>\$32.79</td> </tr> <tr> <td>50-99</td> <td>\$30.32</td> </tr> <tr> <td>100 +</td> <td>\$28.21</td> </tr> </tbody> </table> <p>Model No: PE9682 SMA Male To Reverse Thread SMA Female</p>	PRICE		1-24	\$35.26	25-49	\$32.79	50-99	\$30.32	100 +	\$28.21
	PRICE																																											
1-24	\$34.71																																											
25-49	\$32.28																																											
50-99	\$29.85																																											
100 +	\$27.77																																											
PRICE																																												
1-24	\$32.88																																											
25-49	\$30.58																																											
50-99	\$28.28																																											
100 +	\$26.30																																											
PRICE																																												
1-24	\$23.36																																											
25-49	\$21.72																																											
50-99	\$20.09																																											
100 +	\$18.69																																											
PRICE																																												
1-24	\$35.26																																											
25-49	\$32.79																																											
50-99	\$30.32																																											
100 +	\$28.21																																											
6	 <table border="1"> <thead> <tr> <th colspan="2">PRICE</th> </tr> </thead> <tbody> <tr> <td>1-24</td> <td>\$25.84</td> </tr> <tr> <td>25-49</td> <td>\$24.03</td> </tr> <tr> <td>50-99</td> <td>\$22.22</td> </tr> <tr> <td>100 +</td> <td>\$20.67</td> </tr> </tbody> </table> <p>Model No: PE9683 SMA Female To Reverse Thread SMA Male</p>	PRICE		1-24	\$25.84	25-49	\$24.03	50-99	\$22.22	100 +	\$20.67	<p>SMA</p> <p>Between-Series</p> <p>→</p>		 <table border="1"> <thead> <tr> <th colspan="2">PRICE</th> </tr> </thead> <tbody> <tr> <td>1-24</td> <td>\$144.60</td> </tr> <tr> <td>25-49</td> <td>\$134.48</td> </tr> <tr> <td>50-99</td> <td>\$124.36</td> </tr> <tr> <td>100 +</td> <td>\$115.68</td> </tr> </tbody> </table> <p>PRECISION Model No: PE9723 SMA Male To 3.5mm Female Max VSWR 1.25:1 @ 18 GHz</p>	PRICE		1-24	\$144.60	25-49	\$134.48	50-99	\$124.36	100 +	\$115.68																				
	PRICE																																											
1-24	\$25.84																																											
25-49	\$24.03																																											
50-99	\$22.22																																											
100 +	\$20.67																																											
PRICE																																												
1-24	\$144.60																																											
25-49	\$134.48																																											
50-99	\$124.36																																											
100 +	\$115.68																																											

Adapters

See Our Website For Real-Time Stock Availability!











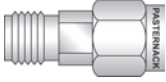
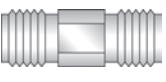

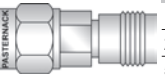
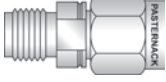
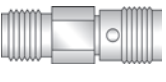
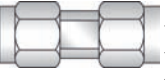
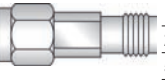
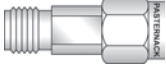
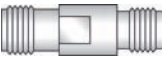
ADAPTERS

See Adapter Locator on Pages 140-145 or the Adapter Matrix on Pages 138-139

See Page 246 for Mounting Holes

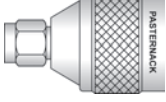
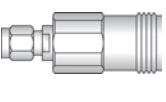
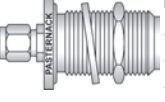
Adapters

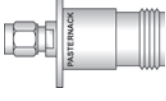

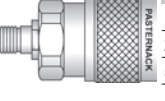





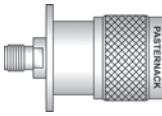

See Our Website For Real-Time Stock Availability!

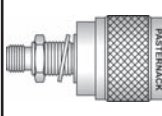
	A	B	C	D																																								
1	 <table border="1"> <thead> <tr> <th colspan="2">PRICE</th> </tr> </thead> <tbody> <tr> <td>1-24</td> <td>\$146.02</td> </tr> <tr> <td>25-49</td> <td>\$135.80</td> </tr> <tr> <td>50-99</td> <td>\$125.58</td> </tr> <tr> <td>100 +</td> <td>\$116.82</td> </tr> </tbody> </table> <p>PRECISION Model No: PE9724 SMA Female To 3.5mm Male Max VSWR 1.25:1 @ 18 GHz</p>	PRICE		1-24	\$146.02	25-49	\$135.80	50-99	\$125.58	100 +	\$116.82	 <table border="1"> <thead> <tr> <th colspan="2">PRICE</th> </tr> </thead> <tbody> <tr> <td>1-24</td> <td>\$148.85</td> </tr> <tr> <td>25-49</td> <td>\$138.43</td> </tr> <tr> <td>50-99</td> <td>\$128.01</td> </tr> <tr> <td>100 +</td> <td>\$119.08</td> </tr> </tbody> </table> <p>PRECISION Model No: PE9725 SMA Female To 3.5mm Female Max VSWR 1.25:1 @ 18 GHz</p>	PRICE		1-24	\$148.85	25-49	\$138.43	50-99	\$128.01	100 +	\$119.08	 <table border="1"> <thead> <tr> <th colspan="2">PRICE</th> </tr> </thead> <tbody> <tr> <td>1-24</td> <td>\$156.45</td> </tr> <tr> <td>25-49</td> <td>\$145.50</td> </tr> <tr> <td>50-99</td> <td>\$134.55</td> </tr> <tr> <td>100 +</td> <td>\$125.16</td> </tr> </tbody> </table> <p>PRECISION Model No: PE9653 SMA Male To 2.4mm Male Max VSWR 1.20:1 @ 26.5 GHz</p>	PRICE		1-24	\$156.45	25-49	\$145.50	50-99	\$134.55	100 +	\$125.16	 <table border="1"> <thead> <tr> <th colspan="2">PRICE</th> </tr> </thead> <tbody> <tr> <td>1-24</td> <td>\$172.21</td> </tr> <tr> <td>25-49</td> <td>\$160.16</td> </tr> <tr> <td>50-99</td> <td>\$148.10</td> </tr> <tr> <td>100 +</td> <td>\$137.77</td> </tr> </tbody> </table> <p>PRECISION Model No: PE9654 SMA Male To 2.4mm Female Max VSWR 1.20:1 @ 26.5 GHz</p>	PRICE		1-24	\$172.21	25-49	\$160.16	50-99	\$148.10	100 +	\$137.77
	PRICE																																											
1-24	\$146.02																																											
25-49	\$135.80																																											
50-99	\$125.58																																											
100 +	\$116.82																																											
PRICE																																												
1-24	\$148.85																																											
25-49	\$138.43																																											
50-99	\$128.01																																											
100 +	\$119.08																																											
PRICE																																												
1-24	\$156.45																																											
25-49	\$145.50																																											
50-99	\$134.55																																											
100 +	\$125.16																																											
PRICE																																												
1-24	\$172.21																																											
25-49	\$160.16																																											
50-99	\$148.10																																											
100 +	\$137.77																																											
2	 <table border="1"> <thead> <tr> <th colspan="2">PRICE</th> </tr> </thead> <tbody> <tr> <td>1-24</td> <td>\$162.08</td> </tr> <tr> <td>25-49</td> <td>\$150.73</td> </tr> <tr> <td>50-99</td> <td>\$139.39</td> </tr> <tr> <td>100 +</td> <td>\$129.66</td> </tr> </tbody> </table> <p>PRECISION Model No: PE9655 SMA Female To 2.4mm Male Max VSWR 1.20:1 @ 26.5 GHz</p>	PRICE		1-24	\$162.08	25-49	\$150.73	50-99	\$139.39	100 +	\$129.66	 <table border="1"> <thead> <tr> <th colspan="2">PRICE</th> </tr> </thead> <tbody> <tr> <td>1-24</td> <td>\$164.81</td> </tr> <tr> <td>25-49</td> <td>\$153.27</td> </tr> <tr> <td>50-99</td> <td>\$141.74</td> </tr> <tr> <td>100 +</td> <td>\$131.85</td> </tr> </tbody> </table> <p>PRECISION Model No: PE9656 SMA Female To 2.4mm Female Max VSWR 1.20:1 @ 26.5 GHz</p>	PRICE		1-24	\$164.81	25-49	\$153.27	50-99	\$141.74	100 +	\$131.85	 <table border="1"> <thead> <tr> <th colspan="2">PRICE</th> </tr> </thead> <tbody> <tr> <td>1-24</td> <td>\$153.01</td> </tr> <tr> <td>25-49</td> <td>\$142.30</td> </tr> <tr> <td>50-99</td> <td>\$131.59</td> </tr> <tr> <td>100 +</td> <td>\$122.41</td> </tr> </tbody> </table> <p>PRECISION Model No: PE9727 SMA Male To 1.85mm Male Max VSWR 1.30:1 @ 18 GHz</p>	PRICE		1-24	\$153.01	25-49	\$142.30	50-99	\$131.59	100 +	\$122.41	 <table border="1"> <thead> <tr> <th colspan="2">PRICE</th> </tr> </thead> <tbody> <tr> <td>1-24</td> <td>\$153.01</td> </tr> <tr> <td>25-49</td> <td>\$142.30</td> </tr> <tr> <td>50-99</td> <td>\$131.59</td> </tr> <tr> <td>100 +</td> <td>\$122.41</td> </tr> </tbody> </table> <p>PRECISION Model No: PE9728 SMA Male To 1.85mm Female Max VSWR 1.30:1 @ 18 GHz</p>	PRICE		1-24	\$153.01	25-49	\$142.30	50-99	\$131.59	100 +	\$122.41
	PRICE																																											
1-24	\$162.08																																											
25-49	\$150.73																																											
50-99	\$139.39																																											
100 +	\$129.66																																											
PRICE																																												
1-24	\$164.81																																											
25-49	\$153.27																																											
50-99	\$141.74																																											
100 +	\$131.85																																											
PRICE																																												
1-24	\$153.01																																											
25-49	\$142.30																																											
50-99	\$131.59																																											
100 +	\$122.41																																											
PRICE																																												
1-24	\$153.01																																											
25-49	\$142.30																																											
50-99	\$131.59																																											
100 +	\$122.41																																											
3	 <table border="1"> <thead> <tr> <th colspan="2">PRICE</th> </tr> </thead> <tbody> <tr> <td>1-24</td> <td>\$153.01</td> </tr> <tr> <td>25-49</td> <td>\$142.30</td> </tr> <tr> <td>50-99</td> <td>\$131.59</td> </tr> <tr> <td>100 +</td> <td>\$122.41</td> </tr> </tbody> </table> <p>PRECISION Model No: PE9726 SMA Female To 1.85mm Male Max VSWR 1.30:1 @ 18 GHz</p>	PRICE		1-24	\$153.01	25-49	\$142.30	50-99	\$131.59	100 +	\$122.41	 <table border="1"> <thead> <tr> <th colspan="2">PRICE</th> </tr> </thead> <tbody> <tr> <td>1-24</td> <td>\$153.01</td> </tr> <tr> <td>25-49</td> <td>\$142.30</td> </tr> <tr> <td>50-99</td> <td>\$131.59</td> </tr> <tr> <td>100 +</td> <td>\$122.41</td> </tr> </tbody> </table> <p>PRECISION Model No: PE9729 SMA Female To 1.85mm Female Max VSWR 1.30:1 @ 18 GHz</p>	PRICE		1-24	\$153.01	25-49	\$142.30	50-99	\$131.59	100 +	\$122.41	 <table border="1"> <thead> <tr> <th colspan="2">PRICE</th> </tr> </thead> <tbody> <tr> <td>1-24</td> <td>\$47.12</td> </tr> <tr> <td>25-49</td> <td>\$43.82</td> </tr> <tr> <td>50-99</td> <td>\$40.52</td> </tr> <tr> <td>100 +</td> <td>\$37.70</td> </tr> </tbody> </table> <p>PRECISION Model No: PE9187 SMA Male To SSMA Male</p>	PRICE		1-24	\$47.12	25-49	\$43.82	50-99	\$40.52	100 +	\$37.70	 <table border="1"> <thead> <tr> <th colspan="2">PRICE</th> </tr> </thead> <tbody> <tr> <td>1-24</td> <td>\$41.09</td> </tr> <tr> <td>25-49</td> <td>\$38.21</td> </tr> <tr> <td>50-99</td> <td>\$35.34</td> </tr> <tr> <td>100 +</td> <td>\$32.87</td> </tr> </tbody> </table> <p>PRECISION Model No: PE9063 SMA Male To SSMA Female</p>	PRICE		1-24	\$41.09	25-49	\$38.21	50-99	\$35.34	100 +	\$32.87
	PRICE																																											
1-24	\$153.01																																											
25-49	\$142.30																																											
50-99	\$131.59																																											
100 +	\$122.41																																											
PRICE																																												
1-24	\$153.01																																											
25-49	\$142.30																																											
50-99	\$131.59																																											
100 +	\$122.41																																											
PRICE																																												
1-24	\$47.12																																											
25-49	\$43.82																																											
50-99	\$40.52																																											
100 +	\$37.70																																											
PRICE																																												
1-24	\$41.09																																											
25-49	\$38.21																																											
50-99	\$35.34																																											
100 +	\$32.87																																											
4	 <table border="1"> <thead> <tr> <th colspan="2">PRICE</th> </tr> </thead> <tbody> <tr> <td>1-24</td> <td>\$38.15</td> </tr> <tr> <td>25-49</td> <td>\$35.48</td> </tr> <tr> <td>50-99</td> <td>\$32.81</td> </tr> <tr> <td>100 +</td> <td>\$30.52</td> </tr> </tbody> </table> <p>PRECISION Model No: PE9188 SMA Female To SSMA Male</p>	PRICE		1-24	\$38.15	25-49	\$35.48	50-99	\$32.81	100 +	\$30.52	 <table border="1"> <thead> <tr> <th colspan="2">PRICE</th> </tr> </thead> <tbody> <tr> <td>1-24</td> <td>\$46.21</td> </tr> <tr> <td>25-49</td> <td>\$42.98</td> </tr> <tr> <td>50-99</td> <td>\$39.74</td> </tr> <tr> <td>100 +</td> <td>\$36.97</td> </tr> </tbody> </table> <p>PRECISION Model No: PE9399 SMA Female To SSMA Female</p>	PRICE		1-24	\$46.21	25-49	\$42.98	50-99	\$39.74	100 +	\$36.97	 <table border="1"> <thead> <tr> <th colspan="2">PRICE</th> </tr> </thead> <tbody> <tr> <td>1-24</td> <td>\$92.56</td> </tr> <tr> <td>25-49</td> <td>\$86.08</td> </tr> <tr> <td>50-99</td> <td>\$79.60</td> </tr> <tr> <td>100 +</td> <td>\$74.05</td> </tr> </tbody> </table> <p>PRECISION Model No: PE9431 SMA Male To N Male Max VSWR 1.15:1 @ 18 GHz</p>	PRICE		1-24	\$92.56	25-49	\$86.08	50-99	\$79.60	100 +	\$74.05	 <table border="1"> <thead> <tr> <th colspan="2">PRICE</th> </tr> </thead> <tbody> <tr> <td>1-24</td> <td>\$105.89</td> </tr> <tr> <td>25-49</td> <td>\$98.48</td> </tr> <tr> <td>50-99</td> <td>\$91.07</td> </tr> <tr> <td>100 +</td> <td>\$84.71</td> </tr> </tbody> </table> <p>PRECISION Model No: PE9499 SMA Male To N Female Panel Mount, Mounting Hole A05 Max VSWR 1.15:1 @ 18 GHz</p>	PRICE		1-24	\$105.89	25-49	\$98.48	50-99	\$91.07	100 +	\$84.71
	PRICE																																											
1-24	\$38.15																																											
25-49	\$35.48																																											
50-99	\$32.81																																											
100 +	\$30.52																																											
PRICE																																												
1-24	\$46.21																																											
25-49	\$42.98																																											
50-99	\$39.74																																											
100 +	\$36.97																																											
PRICE																																												
1-24	\$92.56																																											
25-49	\$86.08																																											
50-99	\$79.60																																											
100 +	\$74.05																																											
PRICE																																												
1-24	\$105.89																																											
25-49	\$98.48																																											
50-99	\$91.07																																											
100 +	\$84.71																																											
5	 <table border="1"> <thead> <tr> <th colspan="2">PRICE</th> </tr> </thead> <tbody> <tr> <td>1-24</td> <td>\$40.63</td> </tr> <tr> <td>25-49</td> <td>\$37.79</td> </tr> <tr> <td>50-99</td> <td>\$34.94</td> </tr> <tr> <td>100 +</td> <td>\$32.50</td> </tr> </tbody> </table> <p>PRECISION Model No: PE9080 SMA Male To N Male</p>	PRICE		1-24	\$40.63	25-49	\$37.79	50-99	\$34.94	100 +	\$32.50	 <table border="1"> <thead> <tr> <th colspan="2">PRICE</th> </tr> </thead> <tbody> <tr> <td>1-24</td> <td>\$75.36</td> </tr> <tr> <td>25-49</td> <td>\$70.08</td> </tr> <tr> <td>50-99</td> <td>\$64.81</td> </tr> <tr> <td>100 +</td> <td>\$60.29</td> </tr> </tbody> </table> <p>PRECISION Model No: PE9433 SMA Male To N Female Max VSWR 1.15:1 @ 18 GHz</p>	PRICE		1-24	\$75.36	25-49	\$70.08	50-99	\$64.81	100 +	\$60.29	 <table border="1"> <thead> <tr> <th colspan="2">PRICE</th> </tr> </thead> <tbody> <tr> <td>1-24</td> <td>\$104.12</td> </tr> <tr> <td>25-49</td> <td>\$96.83</td> </tr> <tr> <td>50-99</td> <td>\$89.54</td> </tr> <tr> <td>100 +</td> <td>\$83.30</td> </tr> </tbody> </table> <p>PRECISION Model No: PE9487 SMA Male To N Female Bulkhead Max VSWR 1.15:1 @ 18 GHz Mounting Hole G01</p>	PRICE		1-24	\$104.12	25-49	\$96.83	50-99	\$89.54	100 +	\$83.30	 <table border="1"> <thead> <tr> <th colspan="2">PRICE</th> </tr> </thead> <tbody> <tr> <td>1-24</td> <td>\$105.84</td> </tr> <tr> <td>25-49</td> <td>\$98.43</td> </tr> <tr> <td>50-99</td> <td>\$91.02</td> </tr> <tr> <td>100 +</td> <td>\$84.67</td> </tr> </tbody> </table> <p>PRECISION Model No: PE9488 SMA Male Bulkhead To N Female Nut On SMA, Mounting Hole G01 Max VSWR 1.15:1 @ 18 GHz</p>	PRICE		1-24	\$105.84	25-49	\$98.43	50-99	\$91.02	100 +	\$84.67
	PRICE																																											
1-24	\$40.63																																											
25-49	\$37.79																																											
50-99	\$34.94																																											
100 +	\$32.50																																											
PRICE																																												
1-24	\$75.36																																											
25-49	\$70.08																																											
50-99	\$64.81																																											
100 +	\$60.29																																											
PRICE																																												
1-24	\$104.12																																											
25-49	\$96.83																																											
50-99	\$89.54																																											
100 +	\$83.30																																											
PRICE																																												
1-24	\$105.84																																											
25-49	\$98.43																																											
50-99	\$91.02																																											
100 +	\$84.67																																											
6	 <table border="1"> <thead> <tr> <th colspan="2">PRICE</th> </tr> </thead> <tbody> <tr> <td>1-24</td> <td>\$108.17</td> </tr> <tr> <td>25-49</td> <td>\$100.60</td> </tr> <tr> <td>50-99</td> <td>\$93.03</td> </tr> <tr> <td>100 +</td> <td>\$86.54</td> </tr> </tbody> </table> <p>PRECISION Model No: PE9497 SMA Male To N Female Panel Mount, Mounting Hole A05 Max VSWR 1.15:1 @ 18 GHz</p>	PRICE		1-24	\$108.17	25-49	\$100.60	50-99	\$93.03	100 +	\$86.54	 <table border="1"> <thead> <tr> <th colspan="2">PRICE</th> </tr> </thead> <tbody> <tr> <td>1-24</td> <td>\$42.66</td> </tr> <tr> <td>25-49</td> <td>\$39.67</td> </tr> <tr> <td>50-99</td> <td>\$36.69</td> </tr> <tr> <td>100 +</td> <td>\$34.13</td> </tr> </tbody> </table> <p>PRECISION Model No: PE9082 SMA Male To N Female</p>	PRICE		1-24	\$42.66	25-49	\$39.67	50-99	\$36.69	100 +	\$34.13	 <table border="1"> <thead> <tr> <th colspan="2">PRICE</th> </tr> </thead> <tbody> <tr> <td>1-24</td> <td>\$71.33</td> </tr> <tr> <td>25-49</td> <td>\$66.34</td> </tr> <tr> <td>50-99</td> <td>\$61.34</td> </tr> <tr> <td>100 +</td> <td>\$57.06</td> </tr> </tbody> </table> <p>PRECISION Model No: PE9105 SMA Male To N Female Panel Mount Mounting Hole A05</p>	PRICE		1-24	\$71.33	25-49	\$66.34	50-99	\$61.34	100 +	\$57.06	 <table border="1"> <thead> <tr> <th colspan="2">PRICE</th> </tr> </thead> <tbody> <tr> <td>1-24</td> <td>\$70.88</td> </tr> <tr> <td>25-49</td> <td>\$65.92</td> </tr> <tr> <td>50-99</td> <td>\$60.96</td> </tr> <tr> <td>100 +</td> <td>\$56.70</td> </tr> </tbody> </table> <p>PRECISION Model No: PE9430 SMA Female To N Male Max VSWR 1.15:1 @ 18 GHz</p>	PRICE		1-24	\$70.88	25-49	\$65.92	50-99	\$60.96	100 +	\$56.70
	PRICE																																											
1-24	\$108.17																																											
25-49	\$100.60																																											
50-99	\$93.03																																											
100 +	\$86.54																																											
PRICE																																												
1-24	\$42.66																																											
25-49	\$39.67																																											
50-99	\$36.69																																											
100 +	\$34.13																																											
PRICE																																												
1-24	\$71.33																																											
25-49	\$66.34																																											
50-99	\$61.34																																											
100 +	\$57.06																																											
PRICE																																												
1-24	\$70.88																																											
25-49	\$65.92																																											
50-99	\$60.96																																											
100 +	\$56.70																																											

ADAPTERS

See Adapter Locator on Pages 140-145 or the Adapter Matrix on Pages 138-139

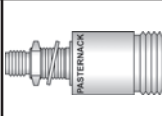
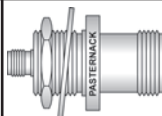
See Page 246 for Mounting Holes

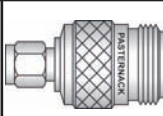
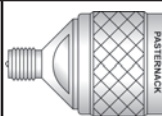
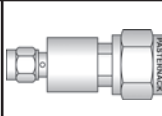
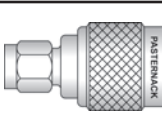
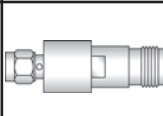
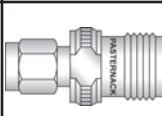
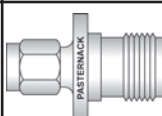
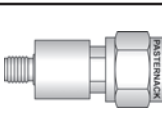
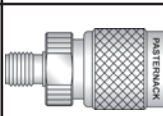
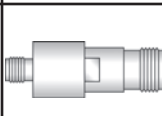
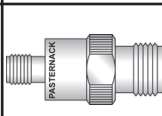
	A	B	C	D																																								
1	 <table border="1"> <thead> <tr> <th colspan="2">PRICE</th> </tr> </thead> <tbody> <tr> <td>1-24</td> <td>\$122.25</td> </tr> <tr> <td>25-49</td> <td>\$113.69</td> </tr> <tr> <td>50-99</td> <td>\$105.14</td> </tr> <tr> <td>100 +</td> <td>\$97.80</td> </tr> </tbody> </table> <p>PRECISION</p> <p>Model No: PE9498</p> <p>SMA Female To N Male Panel Mount, Mounting Hole A05 Max VSWR 1.15:1 @ 18 GHz</p>	PRICE		1-24	\$122.25	25-49	\$113.69	50-99	\$105.14	100 +	\$97.80	 <table border="1"> <thead> <tr> <th colspan="2">PRICE</th> </tr> </thead> <tbody> <tr> <td>1-24</td> <td>\$40.89</td> </tr> <tr> <td>25-49</td> <td>\$38.03</td> </tr> <tr> <td>50-99</td> <td>\$35.17</td> </tr> <tr> <td>100 +</td> <td>\$32.71</td> </tr> </tbody> </table> <p>PRECISION</p> <p>Model No: PE9081</p> <p>SMA Female To N Male</p>	PRICE		1-24	\$40.89	25-49	\$38.03	50-99	\$35.17	100 +	\$32.71	 <table border="1"> <thead> <tr> <th colspan="2">PRICE</th> </tr> </thead> <tbody> <tr> <td>1-24</td> <td>\$117.64</td> </tr> <tr> <td>25-49</td> <td>\$109.41</td> </tr> <tr> <td>50-99</td> <td>\$101.17</td> </tr> <tr> <td>100 +</td> <td>\$94.11</td> </tr> </tbody> </table> <p>PRECISION</p> <p>Model No: PE9684</p> <p>SMA Female To N Male Quick Disconnect</p>	PRICE		1-24	\$117.64	25-49	\$109.41	50-99	\$101.17	100 +	\$94.11	 <table border="1"> <thead> <tr> <th colspan="2">PRICE</th> </tr> </thead> <tbody> <tr> <td>1-24</td> <td>\$50.61</td> </tr> <tr> <td>25-49</td> <td>\$47.07</td> </tr> <tr> <td>50-99</td> <td>\$43.52</td> </tr> <tr> <td>100 +</td> <td>\$40.49</td> </tr> </tbody> </table> <p>PRECISION</p> <p>Model No: PE9551</p> <p>SMA Female Bulkhead To N Male Mounting Hole B09</p>	PRICE		1-24	\$50.61	25-49	\$47.07	50-99	\$43.52	100 +	\$40.49
	PRICE																																											
	1-24	\$122.25																																										
	25-49	\$113.69																																										
	50-99	\$105.14																																										
	100 +	\$97.80																																										
PRICE																																												
1-24	\$40.89																																											
25-49	\$38.03																																											
50-99	\$35.17																																											
100 +	\$32.71																																											
PRICE																																												
1-24	\$117.64																																											
25-49	\$109.41																																											
50-99	\$101.17																																											
100 +	\$94.11																																											
PRICE																																												
1-24	\$50.61																																											
25-49	\$47.07																																											
50-99	\$43.52																																											
100 +	\$40.49																																											
2	 <table border="1"> <thead> <tr> <th colspan="2">PRICE</th> </tr> </thead> <tbody> <tr> <td>1-24</td> <td>\$71.80</td> </tr> <tr> <td>25-49</td> <td>\$66.77</td> </tr> <tr> <td>50-99</td> <td>\$61.75</td> </tr> <tr> <td>100 +</td> <td>\$57.44</td> </tr> </tbody> </table> <p>PRECISION</p> <p>Model No: PE9275</p> <p>SMA Female To N Male Panel Mount Mounting Hole A05</p>	PRICE		1-24	\$71.80	25-49	\$66.77	50-99	\$61.75	100 +	\$57.44	 <table border="1"> <thead> <tr> <th colspan="2">PRICE</th> </tr> </thead> <tbody> <tr> <td>1-24</td> <td>\$71.94</td> </tr> <tr> <td>25-49</td> <td>\$66.90</td> </tr> <tr> <td>50-99</td> <td>\$61.87</td> </tr> <tr> <td>100 +</td> <td>\$57.55</td> </tr> </tbody> </table> <p>PRECISION</p> <p>Model No: PE9432</p> <p>SMA Female To N Female Max VSWR 1.15:1 @ 18 GHz</p>	PRICE		1-24	\$71.94	25-49	\$66.90	50-99	\$61.87	100 +	\$57.55	 <table border="1"> <thead> <tr> <th colspan="2">PRICE</th> </tr> </thead> <tbody> <tr> <td>1-24</td> <td>\$115.67</td> </tr> <tr> <td>25-49</td> <td>\$107.57</td> </tr> <tr> <td>50-99</td> <td>\$99.48</td> </tr> <tr> <td>100 +</td> <td>\$92.54</td> </tr> </tbody> </table> <p>PRECISION</p> <p>Model No: PE9486</p> <p>SMA Female To N Female Bulkhead, Mounting Hole G01 Max VSWR 1.15:1 @ 18 GHz</p>	PRICE		1-24	\$115.67	25-49	\$107.57	50-99	\$99.48	100 +	\$92.54	 <table border="1"> <thead> <tr> <th colspan="2">PRICE</th> </tr> </thead> <tbody> <tr> <td>1-24</td> <td>\$115.67</td> </tr> <tr> <td>25-49</td> <td>\$107.57</td> </tr> <tr> <td>50-99</td> <td>\$99.48</td> </tr> <tr> <td>100 +</td> <td>\$92.54</td> </tr> </tbody> </table> <p>PRECISION</p> <p>Model No: PE9434</p> <p>SMA Female To N Female Panel Mount, Mounting Hole A05 Max VSWR 1.15:1 @ 18 GHz</p>	PRICE		1-24	\$115.67	25-49	\$107.57	50-99	\$99.48	100 +	\$92.54
	PRICE																																											
1-24	\$71.80																																											
25-49	\$66.77																																											
50-99	\$61.75																																											
100 +	\$57.44																																											
PRICE																																												
1-24	\$71.94																																											
25-49	\$66.90																																											
50-99	\$61.87																																											
100 +	\$57.55																																											
PRICE																																												
1-24	\$115.67																																											
25-49	\$107.57																																											
50-99	\$99.48																																											
100 +	\$92.54																																											
PRICE																																												
1-24	\$115.67																																											
25-49	\$107.57																																											
50-99	\$99.48																																											
100 +	\$92.54																																											
3	 <table border="1"> <thead> <tr> <th colspan="2">PRICE</th> </tr> </thead> <tbody> <tr> <td>1-24</td> <td>\$40.33</td> </tr> <tr> <td>25-49</td> <td>\$37.51</td> </tr> <tr> <td>50-99</td> <td>\$34.68</td> </tr> <tr> <td>100 +</td> <td>\$32.26</td> </tr> </tbody> </table> <p>PRECISION</p> <p>Model No: PE9083</p> <p>SMA Female To N Female</p>	PRICE		1-24	\$40.33	25-49	\$37.51	50-99	\$34.68	100 +	\$32.26	 <table border="1"> <thead> <tr> <th colspan="2">PRICE</th> </tr> </thead> <tbody> <tr> <td>1-24</td> <td>\$38.91</td> </tr> <tr> <td>25-49</td> <td>\$36.19</td> </tr> <tr> <td>50-99</td> <td>\$33.46</td> </tr> <tr> <td>100 +</td> <td>\$31.13</td> </tr> </tbody> </table> <p>PRECISION</p> <p>Model No: PE9252</p> <p>SMA Female To N Female Bulkhead Mounting Hole G01</p>	PRICE		1-24	\$38.91	25-49	\$36.19	50-99	\$33.46	100 +	\$31.13	 <table border="1"> <thead> <tr> <th colspan="2">PRICE</th> </tr> </thead> <tbody> <tr> <td>1-24</td> <td>\$50.72</td> </tr> <tr> <td>25-49</td> <td>\$47.17</td> </tr> <tr> <td>50-99</td> <td>\$43.62</td> </tr> <tr> <td>100 +</td> <td>\$40.58</td> </tr> </tbody> </table> <p>PRECISION</p> <p>Model No: PE9408</p> <p>SMA Female Bulkhead To N Female, Nut On SMA Mounting Hole B09</p>	PRICE		1-24	\$50.72	25-49	\$47.17	50-99	\$43.62	100 +	\$40.58	 <table border="1"> <thead> <tr> <th colspan="2">PRICE</th> </tr> </thead> <tbody> <tr> <td>1-24</td> <td>\$113.29</td> </tr> <tr> <td>25-49</td> <td>\$105.36</td> </tr> <tr> <td>50-99</td> <td>\$97.43</td> </tr> <tr> <td>100 +</td> <td>\$90.63</td> </tr> </tbody> </table> <p>PRECISION</p> <p>Model No: PE9435</p> <p>SMA Female Bulkhead To N Female, Nut On SMA Max VSWR 1.15:1 @ 18 GHz Mounting Hole G01</p>	PRICE		1-24	\$113.29	25-49	\$105.36	50-99	\$97.43	100 +	\$90.63
	PRICE																																											
1-24	\$40.33																																											
25-49	\$37.51																																											
50-99	\$34.68																																											
100 +	\$32.26																																											
PRICE																																												
1-24	\$38.91																																											
25-49	\$36.19																																											
50-99	\$33.46																																											
100 +	\$31.13																																											
PRICE																																												
1-24	\$50.72																																											
25-49	\$47.17																																											
50-99	\$43.62																																											
100 +	\$40.58																																											
PRICE																																												
1-24	\$113.29																																											
25-49	\$105.36																																											
50-99	\$97.43																																											
100 +	\$90.63																																											
4	 <table border="1"> <thead> <tr> <th colspan="2">PRICE</th> </tr> </thead> <tbody> <tr> <td>1-24</td> <td>\$46.76</td> </tr> <tr> <td>25-49</td> <td>\$43.49</td> </tr> <tr> <td>50-99</td> <td>\$40.21</td> </tr> <tr> <td>100 +</td> <td>\$37.41</td> </tr> </tbody> </table> <p>PRECISION</p> <p>Model No: PE9104</p> <p>SMA Female To N Female Panel Mount Mounting Hole A05</p>	PRICE		1-24	\$46.76	25-49	\$43.49	50-99	\$40.21	100 +	\$37.41	 <table border="1"> <thead> <tr> <th colspan="2">PRICE</th> </tr> </thead> <tbody> <tr> <td>1-24</td> <td>\$56.80</td> </tr> <tr> <td>25-49</td> <td>\$52.82</td> </tr> <tr> <td>50-99</td> <td>\$48.85</td> </tr> <tr> <td>100 +</td> <td>\$45.44</td> </tr> </tbody> </table> <p>PRECISION</p> <p>Model No: PE9732</p> <p>Reverse Polarity SMA Male To N Female</p>	PRICE		1-24	\$56.80	25-49	\$52.82	50-99	\$48.85	100 +	\$45.44	 <table border="1"> <thead> <tr> <th colspan="2">PRICE</th> </tr> </thead> <tbody> <tr> <td>1-24</td> <td>\$56.80</td> </tr> <tr> <td>25-49</td> <td>\$52.82</td> </tr> <tr> <td>50-99</td> <td>\$48.85</td> </tr> <tr> <td>100 +</td> <td>\$45.44</td> </tr> </tbody> </table> <p>PRECISION</p> <p>Model No: PE9733</p> <p>Reverse Polarity SMA Female To N Male</p>	PRICE		1-24	\$56.80	25-49	\$52.82	50-99	\$48.85	100 +	\$45.44	 <table border="1"> <thead> <tr> <th colspan="2">PRICE</th> </tr> </thead> <tbody> <tr> <td>1-24</td> <td>\$86.79</td> </tr> <tr> <td>25-49</td> <td>\$80.71</td> </tr> <tr> <td>50-99</td> <td>\$74.64</td> </tr> <tr> <td>100 +</td> <td>\$69.43</td> </tr> </tbody> </table> <p>PRECISION</p> <p>Model No: PE9439</p> <p>SMA Male To TNC Male Max VSWR 1.25:1 @ 18 GHz</p>	PRICE		1-24	\$86.79	25-49	\$80.71	50-99	\$74.64	100 +	\$69.43
	PRICE																																											
1-24	\$46.76																																											
25-49	\$43.49																																											
50-99	\$40.21																																											
100 +	\$37.41																																											
PRICE																																												
1-24	\$56.80																																											
25-49	\$52.82																																											
50-99	\$48.85																																											
100 +	\$45.44																																											
PRICE																																												
1-24	\$56.80																																											
25-49	\$52.82																																											
50-99	\$48.85																																											
100 +	\$45.44																																											
PRICE																																												
1-24	\$86.79																																											
25-49	\$80.71																																											
50-99	\$74.64																																											
100 +	\$69.43																																											
5	 <table border="1"> <thead> <tr> <th colspan="2">PRICE</th> </tr> </thead> <tbody> <tr> <td>1-24</td> <td>\$33.49</td> </tr> <tr> <td>25-49</td> <td>\$31.15</td> </tr> <tr> <td>50-99</td> <td>\$28.80</td> </tr> <tr> <td>100 +</td> <td>\$26.79</td> </tr> </tbody> </table> <p>PRECISION</p> <p>Model No: PE9076</p> <p>SMA Male To TNC Male</p>	PRICE		1-24	\$33.49	25-49	\$31.15	50-99	\$28.80	100 +	\$26.79	 <table border="1"> <thead> <tr> <th colspan="2">PRICE</th> </tr> </thead> <tbody> <tr> <td>1-24</td> <td>\$89.85</td> </tr> <tr> <td>25-49</td> <td>\$83.56</td> </tr> <tr> <td>50-99</td> <td>\$77.27</td> </tr> <tr> <td>100 +</td> <td>\$71.88</td> </tr> </tbody> </table> <p>PRECISION</p> <p>Model No: PE9441</p> <p>SMA Male To TNC Female Max VSWR 1.25:1 @ 18 GHz</p>	PRICE		1-24	\$89.85	25-49	\$83.56	50-99	\$77.27	100 +	\$71.88	 <table border="1"> <thead> <tr> <th colspan="2">PRICE</th> </tr> </thead> <tbody> <tr> <td>1-24</td> <td>\$34.65</td> </tr> <tr> <td>25-49</td> <td>\$32.22</td> </tr> <tr> <td>50-99</td> <td>\$29.80</td> </tr> <tr> <td>100 +</td> <td>\$27.72</td> </tr> </tbody> </table> <p>PRECISION</p> <p>Model No: PE9078</p> <p>SMA Male To TNC Female</p>	PRICE		1-24	\$34.65	25-49	\$32.22	50-99	\$29.80	100 +	\$27.72	 <table border="1"> <thead> <tr> <th colspan="2">PRICE</th> </tr> </thead> <tbody> <tr> <td>1-24</td> <td>\$50.46</td> </tr> <tr> <td>25-49</td> <td>\$46.93</td> </tr> <tr> <td>50-99</td> <td>\$43.40</td> </tr> <tr> <td>100 +</td> <td>\$40.37</td> </tr> </tbody> </table> <p>PRECISION</p> <p>Model No: PE9384</p> <p>SMA Male To TNC Female Panel Mount Mounting Hole A09</p>	PRICE		1-24	\$50.46	25-49	\$46.93	50-99	\$43.40	100 +	\$40.37
	PRICE																																											
1-24	\$33.49																																											
25-49	\$31.15																																											
50-99	\$28.80																																											
100 +	\$26.79																																											
PRICE																																												
1-24	\$89.85																																											
25-49	\$83.56																																											
50-99	\$77.27																																											
100 +	\$71.88																																											
PRICE																																												
1-24	\$34.65																																											
25-49	\$32.22																																											
50-99	\$29.80																																											
100 +	\$27.72																																											
PRICE																																												
1-24	\$50.46																																											
25-49	\$46.93																																											
50-99	\$43.40																																											
100 +	\$40.37																																											
6	 <table border="1"> <thead> <tr> <th colspan="2">PRICE</th> </tr> </thead> <tbody> <tr> <td>1-24</td> <td>\$85.88</td> </tr> <tr> <td>25-49</td> <td>\$79.87</td> </tr> <tr> <td>50-99</td> <td>\$73.86</td> </tr> <tr> <td>100 +</td> <td>\$68.70</td> </tr> </tbody> </table> <p>PRECISION</p> <p>Model No: PE9440</p> <p>SMA Female To TNC Male Max VSWR 1.25:1 @ 18 GHz</p>	PRICE		1-24	\$85.88	25-49	\$79.87	50-99	\$73.86	100 +	\$68.70	 <table border="1"> <thead> <tr> <th colspan="2">PRICE</th> </tr> </thead> <tbody> <tr> <td>1-24</td> <td>\$36.35</td> </tr> <tr> <td>25-49</td> <td>\$33.81</td> </tr> <tr> <td>50-99</td> <td>\$31.26</td> </tr> <tr> <td>100 +</td> <td>\$29.08</td> </tr> </tbody> </table> <p>PRECISION</p> <p>Model No: PE9077</p> <p>SMA Female To TNC Male</p>	PRICE		1-24	\$36.35	25-49	\$33.81	50-99	\$31.26	100 +	\$29.08	 <table border="1"> <thead> <tr> <th colspan="2">PRICE</th> </tr> </thead> <tbody> <tr> <td>1-24</td> <td>\$92.56</td> </tr> <tr> <td>25-49</td> <td>\$86.08</td> </tr> <tr> <td>50-99</td> <td>\$79.60</td> </tr> <tr> <td>100 +</td> <td>\$74.05</td> </tr> </tbody> </table> <p>PRECISION</p> <p>Model No: PE9442</p> <p>SMA Female To TNC Female Max VSWR 1.25:1 @ 18 GHz</p>	PRICE		1-24	\$92.56	25-49	\$86.08	50-99	\$79.60	100 +	\$74.05	 <table border="1"> <thead> <tr> <th colspan="2">PRICE</th> </tr> </thead> <tbody> <tr> <td>1-24</td> <td>\$36.24</td> </tr> <tr> <td>25-49</td> <td>\$33.70</td> </tr> <tr> <td>50-99</td> <td>\$31.17</td> </tr> <tr> <td>100 +</td> <td>\$28.99</td> </tr> </tbody> </table> <p>PRECISION</p> <p>Model No: PE9079</p> <p>SMA Female To TNC Female</p>	PRICE		1-24	\$36.24	25-49	\$33.70	50-99	\$31.17	100 +	\$28.99
	PRICE																																											
1-24	\$85.88																																											
25-49	\$79.87																																											
50-99	\$73.86																																											
100 +	\$68.70																																											
PRICE																																												
1-24	\$36.35																																											
25-49	\$33.81																																											
50-99	\$31.26																																											
100 +	\$29.08																																											
PRICE																																												
1-24	\$92.56																																											
25-49	\$86.08																																											
50-99	\$79.60																																											
100 +	\$74.05																																											
PRICE																																												
1-24	\$36.24																																											
25-49	\$33.70																																											
50-99	\$31.17																																											
100 +	\$28.99																																											

Adapters











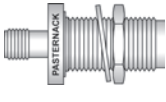

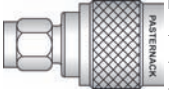

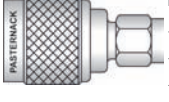
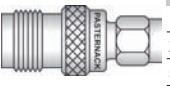
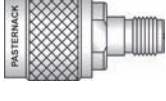
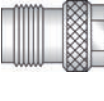
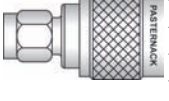
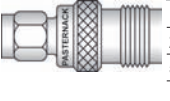

See Our Website For Real-Time Stock Availability!

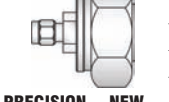

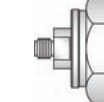
ADAPTERS

See Adapter Locator on Pages 140-145 or the Adapter Matrix on Pages 138-139

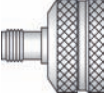
See Page 246 for Mounting Holes

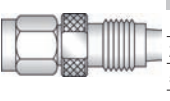
	A	B	C	D																																								
1	 <table border="1"> <thead> <tr> <th colspan="2">PRICE</th> </tr> </thead> <tbody> <tr> <td>1-24</td> <td>\$39.86</td> </tr> <tr> <td>25-49</td> <td>\$37.07</td> </tr> <tr> <td>50-99</td> <td>\$34.28</td> </tr> <tr> <td>100 +</td> <td>\$31.89</td> </tr> </tbody> </table> <p>Model No: PE9251 SMA Female To TNC Female Bulkhead Mounting Hole B05</p>	PRICE		1-24	\$39.86	25-49	\$37.07	50-99	\$34.28	100 +	\$31.89	 <table border="1"> <thead> <tr> <th colspan="2">PRICE</th> </tr> </thead> <tbody> <tr> <td>1-24</td> <td>\$39.67</td> </tr> <tr> <td>25-49</td> <td>\$36.89</td> </tr> <tr> <td>50-99</td> <td>\$34.12</td> </tr> <tr> <td>100 +</td> <td>\$31.74</td> </tr> </tbody> </table> <p>Model No: PE9276 SMA Female To TNC Female Panel Mount Mounting Hole A03</p>	PRICE		1-24	\$39.67	25-49	\$36.89	50-99	\$34.12	100 +	\$31.74	 <table border="1"> <thead> <tr> <th colspan="2">PRICE</th> </tr> </thead> <tbody> <tr> <td>1-24</td> <td>\$45.75</td> </tr> <tr> <td>25-49</td> <td>\$42.55</td> </tr> <tr> <td>50-99</td> <td>\$39.35</td> </tr> <tr> <td>100 +</td> <td>\$36.60</td> </tr> </tbody> </table> <p>Model No: PE9601 SMA Male To Reverse Polarity TNC Male</p>	PRICE		1-24	\$45.75	25-49	\$42.55	50-99	\$39.35	100 +	\$36.60	 <table border="1"> <thead> <tr> <th colspan="2">PRICE</th> </tr> </thead> <tbody> <tr> <td>1-24</td> <td>\$39.97</td> </tr> <tr> <td>25-49</td> <td>\$37.17</td> </tr> <tr> <td>50-99</td> <td>\$34.37</td> </tr> <tr> <td>100 +</td> <td>\$31.98</td> </tr> </tbody> </table> <p>Model No: PE9600 SMA Male To Reverse Polarity TNC Female</p>	PRICE		1-24	\$39.97	25-49	\$37.17	50-99	\$34.37	100 +	\$31.98
PRICE																																												
1-24	\$39.86																																											
25-49	\$37.07																																											
50-99	\$34.28																																											
100 +	\$31.89																																											
PRICE																																												
1-24	\$39.67																																											
25-49	\$36.89																																											
50-99	\$34.12																																											
100 +	\$31.74																																											
PRICE																																												
1-24	\$45.75																																											
25-49	\$42.55																																											
50-99	\$39.35																																											
100 +	\$36.60																																											
PRICE																																												
1-24	\$39.97																																											
25-49	\$37.17																																											
50-99	\$34.37																																											
100 +	\$31.98																																											
2	 <table border="1"> <thead> <tr> <th colspan="2">PRICE</th> </tr> </thead> <tbody> <tr> <td>1-24</td> <td>\$40.63</td> </tr> <tr> <td>25-49</td> <td>\$37.79</td> </tr> <tr> <td>50-99</td> <td>\$34.94</td> </tr> <tr> <td>100 +</td> <td>\$32.50</td> </tr> </tbody> </table> <p>Model No: PE9602 SMA Female To Reverse Polarity TNC Male</p>	PRICE		1-24	\$40.63	25-49	\$37.79	50-99	\$34.94	100 +	\$32.50	 <table border="1"> <thead> <tr> <th colspan="2">PRICE</th> </tr> </thead> <tbody> <tr> <td>1-24</td> <td>\$50.06</td> </tr> <tr> <td>25-49</td> <td>\$46.56</td> </tr> <tr> <td>50-99</td> <td>\$43.05</td> </tr> <tr> <td>100 +</td> <td>\$40.05</td> </tr> </tbody> </table> <p>Model No: PE9603 SMA Female To Reverse Polarity TNC Female</p>	PRICE		1-24	\$50.06	25-49	\$46.56	50-99	\$43.05	100 +	\$40.05	 <table border="1"> <thead> <tr> <th colspan="2">PRICE</th> </tr> </thead> <tbody> <tr> <td>1-24</td> <td>\$47.12</td> </tr> <tr> <td>25-49</td> <td>\$43.82</td> </tr> <tr> <td>50-99</td> <td>\$40.52</td> </tr> <tr> <td>100 +</td> <td>\$37.70</td> </tr> </tbody> </table> <p>Model No: PE9597 Reverse Polarity SMA Male To TNC Male</p>	PRICE		1-24	\$47.12	25-49	\$43.82	50-99	\$40.52	100 +	\$37.70	 <table border="1"> <thead> <tr> <th colspan="2">PRICE</th> </tr> </thead> <tbody> <tr> <td>1-24</td> <td>\$46.21</td> </tr> <tr> <td>25-49</td> <td>\$42.98</td> </tr> <tr> <td>50-99</td> <td>\$39.74</td> </tr> <tr> <td>100 +</td> <td>\$36.97</td> </tr> </tbody> </table> <p>Model No: PE9596 Reverse Polarity SMA Male To TNC Female</p>	PRICE		1-24	\$46.21	25-49	\$42.98	50-99	\$39.74	100 +	\$36.97
PRICE																																												
1-24	\$40.63																																											
25-49	\$37.79																																											
50-99	\$34.94																																											
100 +	\$32.50																																											
PRICE																																												
1-24	\$50.06																																											
25-49	\$46.56																																											
50-99	\$43.05																																											
100 +	\$40.05																																											
PRICE																																												
1-24	\$47.12																																											
25-49	\$43.82																																											
50-99	\$40.52																																											
100 +	\$37.70																																											
PRICE																																												
1-24	\$46.21																																											
25-49	\$42.98																																											
50-99	\$39.74																																											
100 +	\$36.97																																											
3	 <table border="1"> <thead> <tr> <th colspan="2">PRICE</th> </tr> </thead> <tbody> <tr> <td>1-24</td> <td>\$46.21</td> </tr> <tr> <td>25-49</td> <td>\$42.98</td> </tr> <tr> <td>50-99</td> <td>\$39.74</td> </tr> <tr> <td>100 +</td> <td>\$36.97</td> </tr> </tbody> </table> <p>Model No: PE9598 Reverse Polarity SMA Female To TNC Male</p>	PRICE		1-24	\$46.21	25-49	\$42.98	50-99	\$39.74	100 +	\$36.97	 <table border="1"> <thead> <tr> <th colspan="2">PRICE</th> </tr> </thead> <tbody> <tr> <td>1-24</td> <td>\$47.12</td> </tr> <tr> <td>25-49</td> <td>\$43.82</td> </tr> <tr> <td>50-99</td> <td>\$40.52</td> </tr> <tr> <td>100 +</td> <td>\$37.70</td> </tr> </tbody> </table> <p>Model No: PE9599 Reverse Polarity SMA Female To TNC Female</p>	PRICE		1-24	\$47.12	25-49	\$43.82	50-99	\$40.52	100 +	\$37.70	 <table border="1"> <thead> <tr> <th colspan="2">PRICE</th> </tr> </thead> <tbody> <tr> <td>1-24</td> <td>\$47.12</td> </tr> <tr> <td>25-49</td> <td>\$43.82</td> </tr> <tr> <td>50-99</td> <td>\$40.52</td> </tr> <tr> <td>100 +</td> <td>\$37.70</td> </tr> </tbody> </table> <p>Model No: PE9605 Reverse Polarity SMA Male To Reverse Polarity TNC Male</p>	PRICE		1-24	\$47.12	25-49	\$43.82	50-99	\$40.52	100 +	\$37.70	 <table border="1"> <thead> <tr> <th colspan="2">PRICE</th> </tr> </thead> <tbody> <tr> <td>1-24</td> <td>\$55.28</td> </tr> <tr> <td>25-49</td> <td>\$51.41</td> </tr> <tr> <td>50-99</td> <td>\$47.54</td> </tr> <tr> <td>100 +</td> <td>\$44.22</td> </tr> </tbody> </table> <p>Model No: PE9604 Reverse Polarity SMA Male To Reverse Polarity TNC Female</p>	PRICE		1-24	\$55.28	25-49	\$51.41	50-99	\$47.54	100 +	\$44.22
PRICE																																												
1-24	\$46.21																																											
25-49	\$42.98																																											
50-99	\$39.74																																											
100 +	\$36.97																																											
PRICE																																												
1-24	\$47.12																																											
25-49	\$43.82																																											
50-99	\$40.52																																											
100 +	\$37.70																																											
PRICE																																												
1-24	\$47.12																																											
25-49	\$43.82																																											
50-99	\$40.52																																											
100 +	\$37.70																																											
PRICE																																												
1-24	\$55.28																																											
25-49	\$51.41																																											
50-99	\$47.54																																											
100 +	\$44.22																																											
4	 <table border="1"> <thead> <tr> <th colspan="2">PRICE</th> </tr> </thead> <tbody> <tr> <td>1-24</td> <td>\$47.12</td> </tr> <tr> <td>25-49</td> <td>\$43.82</td> </tr> <tr> <td>50-99</td> <td>\$40.52</td> </tr> <tr> <td>100 +</td> <td>\$37.70</td> </tr> </tbody> </table> <p>Model No: PE9607 Reverse Polarity SMA Female To Reverse Polarity TNC Male</p>	PRICE		1-24	\$47.12	25-49	\$43.82	50-99	\$40.52	100 +	\$37.70	 <table border="1"> <thead> <tr> <th colspan="2">PRICE</th> </tr> </thead> <tbody> <tr> <td>1-24</td> <td>\$47.12</td> </tr> <tr> <td>25-49</td> <td>\$43.82</td> </tr> <tr> <td>50-99</td> <td>\$40.52</td> </tr> <tr> <td>100 +</td> <td>\$37.70</td> </tr> </tbody> </table> <p>Model No: PE9606 Reverse Polarity SMA Female To Reverse Polarity TNC Female</p>	PRICE		1-24	\$47.12	25-49	\$43.82	50-99	\$40.52	100 +	\$37.70	 <table border="1"> <thead> <tr> <th colspan="2">PRICE</th> </tr> </thead> <tbody> <tr> <td>1-24</td> <td>\$75.00</td> </tr> <tr> <td>25-49</td> <td>\$69.75</td> </tr> <tr> <td>50-99</td> <td>\$64.50</td> </tr> <tr> <td>100 +</td> <td>\$60.00</td> </tr> </tbody> </table> <p>Model No: PE91043 SMA Male To 7/16 Male Low PIM, Low VSWR</p>	PRICE		1-24	\$75.00	25-49	\$69.75	50-99	\$64.50	100 +	\$60.00	 <table border="1"> <thead> <tr> <th colspan="2">PRICE</th> </tr> </thead> <tbody> <tr> <td>1-24</td> <td>\$68.00</td> </tr> <tr> <td>25-49</td> <td>\$63.24</td> </tr> <tr> <td>50-99</td> <td>\$58.48</td> </tr> <tr> <td>100 +</td> <td>\$54.40</td> </tr> </tbody> </table> <p>Model No: PE91041 SMA Male To 7/16 Female Low PIM, Low VSWR</p>	PRICE		1-24	\$68.00	25-49	\$63.24	50-99	\$58.48	100 +	\$54.40
PRICE																																												
1-24	\$47.12																																											
25-49	\$43.82																																											
50-99	\$40.52																																											
100 +	\$37.70																																											
PRICE																																												
1-24	\$47.12																																											
25-49	\$43.82																																											
50-99	\$40.52																																											
100 +	\$37.70																																											
PRICE																																												
1-24	\$75.00																																											
25-49	\$69.75																																											
50-99	\$64.50																																											
100 +	\$60.00																																											
PRICE																																												
1-24	\$68.00																																											
25-49	\$63.24																																											
50-99	\$58.48																																											
100 +	\$54.40																																											
5	 <table border="1"> <thead> <tr> <th colspan="2">PRICE</th> </tr> </thead> <tbody> <tr> <td>1-24</td> <td>\$94.08</td> </tr> <tr> <td>25-49</td> <td>\$87.49</td> </tr> <tr> <td>50-99</td> <td>\$80.91</td> </tr> <tr> <td>100 +</td> <td>\$75.26</td> </tr> </tbody> </table> <p>Model No: PE9411 SMA Male To 7/16 Female</p>	PRICE		1-24	\$94.08	25-49	\$87.49	50-99	\$80.91	100 +	\$75.26	 <table border="1"> <thead> <tr> <th colspan="2">PRICE</th> </tr> </thead> <tbody> <tr> <td>1-24</td> <td>\$65.00</td> </tr> <tr> <td>25-49</td> <td>\$60.45</td> </tr> <tr> <td>50-99</td> <td>\$55.90</td> </tr> <tr> <td>100 +</td> <td>\$52.00</td> </tr> </tbody> </table> <p>Model No: PE91036 SMA Female To 7/16 Male Low PIM, Low VSWR</p>	PRICE		1-24	\$65.00	25-49	\$60.45	50-99	\$55.90	100 +	\$52.00	 <table border="1"> <thead> <tr> <th colspan="2">PRICE</th> </tr> </thead> <tbody> <tr> <td>1-24</td> <td>\$94.08</td> </tr> <tr> <td>25-49</td> <td>\$87.49</td> </tr> <tr> <td>50-99</td> <td>\$80.91</td> </tr> <tr> <td>100 +</td> <td>\$75.26</td> </tr> </tbody> </table> <p>Model No: PE9412 SMA Female To 7/16 Male</p>	PRICE		1-24	\$94.08	25-49	\$87.49	50-99	\$80.91	100 +	\$75.26	 <table border="1"> <thead> <tr> <th colspan="2">PRICE</th> </tr> </thead> <tbody> <tr> <td>1-24</td> <td>\$65.00</td> </tr> <tr> <td>25-49</td> <td>\$60.45</td> </tr> <tr> <td>50-99</td> <td>\$55.90</td> </tr> <tr> <td>100 +</td> <td>\$52.00</td> </tr> </tbody> </table> <p>Model No: PE91042 SMA Female To 7/16 Female Low PIM, Low VSWR</p>	PRICE		1-24	\$65.00	25-49	\$60.45	50-99	\$55.90	100 +	\$52.00
PRICE																																												
1-24	\$94.08																																											
25-49	\$87.49																																											
50-99	\$80.91																																											
100 +	\$75.26																																											
PRICE																																												
1-24	\$65.00																																											
25-49	\$60.45																																											
50-99	\$55.90																																											
100 +	\$52.00																																											
PRICE																																												
1-24	\$94.08																																											
25-49	\$87.49																																											
50-99	\$80.91																																											
100 +	\$75.26																																											
PRICE																																												
1-24	\$65.00																																											
25-49	\$60.45																																											
50-99	\$55.90																																											
100 +	\$52.00																																											
6	 <table border="1"> <thead> <tr> <th colspan="2">PRICE</th> </tr> </thead> <tbody> <tr> <td>1-24</td> <td>\$31.92</td> </tr> <tr> <td>25-49</td> <td>\$29.69</td> </tr> <tr> <td>50-99</td> <td>\$27.45</td> </tr> <tr> <td>100 +</td> <td>\$25.54</td> </tr> </tbody> </table> <p>Model No: PE9400 SMA Male To UHF Female</p>	PRICE		1-24	\$31.92	25-49	\$29.69	50-99	\$27.45	100 +	\$25.54	 <table border="1"> <thead> <tr> <th colspan="2">PRICE</th> </tr> </thead> <tbody> <tr> <td>1-24</td> <td>\$38.71</td> </tr> <tr> <td>25-49</td> <td>\$36.00</td> </tr> <tr> <td>50-99</td> <td>\$33.29</td> </tr> <tr> <td>100 +</td> <td>\$30.97</td> </tr> </tbody> </table> <p>Model No: PE9415 SMA Female To UHF Male</p>	PRICE		1-24	\$38.71	25-49	\$36.00	50-99	\$33.29	100 +	\$30.97	 <table border="1"> <thead> <tr> <th colspan="2">PRICE</th> </tr> </thead> <tbody> <tr> <td>1-24</td> <td>\$11.50</td> </tr> <tr> <td>25-49</td> <td>\$10.70</td> </tr> <tr> <td>50-99</td> <td>\$9.89</td> </tr> <tr> <td>100 +</td> <td>\$9.20</td> </tr> </tbody> </table> <p>Model No: PE9702 SMA Male To FME Plug</p>	PRICE		1-24	\$11.50	25-49	\$10.70	50-99	\$9.89	100 +	\$9.20	 <table border="1"> <thead> <tr> <th colspan="2">PRICE</th> </tr> </thead> <tbody> <tr> <td>1-24</td> <td>\$12.72</td> </tr> <tr> <td>25-49</td> <td>\$11.83</td> </tr> <tr> <td>50-99</td> <td>\$10.94</td> </tr> <tr> <td>100 +</td> <td>\$10.18</td> </tr> </tbody> </table> <p>Model No: PE9707 SMA Male To FME Jack</p>	PRICE		1-24	\$12.72	25-49	\$11.83	50-99	\$10.94	100 +	\$10.18
PRICE																																												
1-24	\$31.92																																											
25-49	\$29.69																																											
50-99	\$27.45																																											
100 +	\$25.54																																											
PRICE																																												
1-24	\$38.71																																											
25-49	\$36.00																																											
50-99	\$33.29																																											
100 +	\$30.97																																											
PRICE																																												
1-24	\$11.50																																											
25-49	\$10.70																																											
50-99	\$9.89																																											
100 +	\$9.20																																											
PRICE																																												
1-24	\$12.72																																											
25-49	\$11.83																																											
50-99	\$10.94																																											
100 +	\$10.18																																											











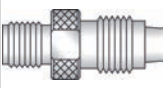
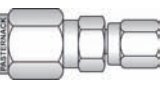
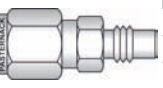

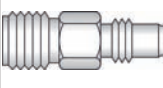
Adapters

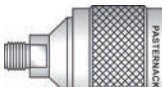
See Our Website For Real-Time Stock Availability!

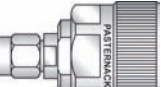
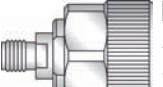
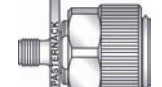
ADAPTERS

See Adapter Locator on Pages 140-145 or the Adapter Matrix on Pages 138-139

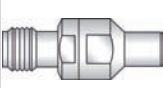
See Page 246 for Mounting Holes

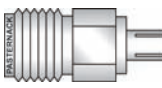
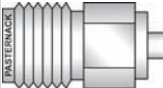
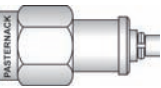
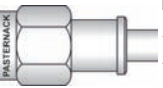
	A	B	C	D																																								
1	 <table border="1"> <thead> <tr> <th colspan="2">PRICE</th> </tr> </thead> <tbody> <tr> <td>1-24</td> <td>\$11.70</td> </tr> <tr> <td>25-49</td> <td>\$10.88</td> </tr> <tr> <td>50-99</td> <td>\$10.06</td> </tr> <tr> <td>100 +</td> <td>\$9.36</td> </tr> </tbody> </table> <p>Model No: PE9703 SMA Female To FME Plug</p>	PRICE		1-24	\$11.70	25-49	\$10.88	50-99	\$10.06	100 +	\$9.36	 <table border="1"> <thead> <tr> <th colspan="2">PRICE</th> </tr> </thead> <tbody> <tr> <td>1-24</td> <td>\$13.88</td> </tr> <tr> <td>25-49</td> <td>\$12.91</td> </tr> <tr> <td>50-99</td> <td>\$11.94</td> </tr> <tr> <td>100 +</td> <td>\$11.10</td> </tr> </tbody> </table> <p>Model No: PE9708 SMA Female To FME Jack</p>	PRICE		1-24	\$13.88	25-49	\$12.91	50-99	\$11.94	100 +	\$11.10	 <table border="1"> <thead> <tr> <th colspan="2">PRICE</th> </tr> </thead> <tbody> <tr> <td>1-24</td> <td>\$39.32</td> </tr> <tr> <td>25-49</td> <td>\$36.57</td> </tr> <tr> <td>50-99</td> <td>\$33.82</td> </tr> <tr> <td>100 +</td> <td>\$31.46</td> </tr> </tbody> </table> <p>Model No: PE9148 SMA Male To SMC Plug</p>	PRICE		1-24	\$39.32	25-49	\$36.57	50-99	\$33.82	100 +	\$31.46	 <table border="1"> <thead> <tr> <th colspan="2">PRICE</th> </tr> </thead> <tbody> <tr> <td>1-24</td> <td>\$40.07</td> </tr> <tr> <td>25-49</td> <td>\$37.27</td> </tr> <tr> <td>50-99</td> <td>\$34.46</td> </tr> <tr> <td>100 +</td> <td>\$32.06</td> </tr> </tbody> </table> <p>Model No: PE9149 SMA Male To SMC Jack</p>	PRICE		1-24	\$40.07	25-49	\$37.27	50-99	\$34.46	100 +	\$32.06
	PRICE																																											
1-24	\$11.70																																											
25-49	\$10.88																																											
50-99	\$10.06																																											
100 +	\$9.36																																											
PRICE																																												
1-24	\$13.88																																											
25-49	\$12.91																																											
50-99	\$11.94																																											
100 +	\$11.10																																											
PRICE																																												
1-24	\$39.32																																											
25-49	\$36.57																																											
50-99	\$33.82																																											
100 +	\$31.46																																											
PRICE																																												
1-24	\$40.07																																											
25-49	\$37.27																																											
50-99	\$34.46																																											
100 +	\$32.06																																											
2	 <table border="1"> <thead> <tr> <th colspan="2">PRICE</th> </tr> </thead> <tbody> <tr> <td>1-24</td> <td>\$42.86</td> </tr> <tr> <td>25-49</td> <td>\$39.86</td> </tr> <tr> <td>50-99</td> <td>\$36.86</td> </tr> <tr> <td>100 +</td> <td>\$34.29</td> </tr> </tbody> </table> <p>Model No: PE9146 SMA Female To SMC Plug</p>	PRICE		1-24	\$42.86	25-49	\$39.86	50-99	\$36.86	100 +	\$34.29	 <table border="1"> <thead> <tr> <th colspan="2">PRICE</th> </tr> </thead> <tbody> <tr> <td>1-24</td> <td>\$40.07</td> </tr> <tr> <td>25-49</td> <td>\$37.27</td> </tr> <tr> <td>50-99</td> <td>\$34.46</td> </tr> <tr> <td>100 +</td> <td>\$32.06</td> </tr> </tbody> </table> <p>Model No: PE9147 SMA Female To SMC Jack</p>	PRICE		1-24	\$40.07	25-49	\$37.27	50-99	\$34.46	100 +	\$32.06	 <table border="1"> <thead> <tr> <th colspan="2">PRICE</th> </tr> </thead> <tbody> <tr> <td>1-24</td> <td>\$58.87</td> </tr> <tr> <td>25-49</td> <td>\$54.75</td> </tr> <tr> <td>50-99</td> <td>\$50.63</td> </tr> <tr> <td>100 +</td> <td>\$47.10</td> </tr> </tbody> </table> <p>Model No: PE9254 SMA Male To HN Male</p>	PRICE		1-24	\$58.87	25-49	\$54.75	50-99	\$50.63	100 +	\$47.10	 <table border="1"> <thead> <tr> <th colspan="2">PRICE</th> </tr> </thead> <tbody> <tr> <td>1-24</td> <td>\$76.40</td> </tr> <tr> <td>25-49</td> <td>\$71.05</td> </tr> <tr> <td>50-99</td> <td>\$65.70</td> </tr> <tr> <td>100 +</td> <td>\$61.12</td> </tr> </tbody> </table> <p>Model No: PE9256 SMA Male To HN Female</p>	PRICE		1-24	\$76.40	25-49	\$71.05	50-99	\$65.70	100 +	\$61.12
	PRICE																																											
1-24	\$42.86																																											
25-49	\$39.86																																											
50-99	\$36.86																																											
100 +	\$34.29																																											
PRICE																																												
1-24	\$40.07																																											
25-49	\$37.27																																											
50-99	\$34.46																																											
100 +	\$32.06																																											
PRICE																																												
1-24	\$58.87																																											
25-49	\$54.75																																											
50-99	\$50.63																																											
100 +	\$47.10																																											
PRICE																																												
1-24	\$76.40																																											
25-49	\$71.05																																											
50-99	\$65.70																																											
100 +	\$61.12																																											
3	 <table border="1"> <thead> <tr> <th colspan="2">PRICE</th> </tr> </thead> <tbody> <tr> <td>1-24</td> <td>\$58.87</td> </tr> <tr> <td>25-49</td> <td>\$54.75</td> </tr> <tr> <td>50-99</td> <td>\$50.63</td> </tr> <tr> <td>100 +</td> <td>\$47.10</td> </tr> </tbody> </table> <p>Model No: PE9253 SMA Female To HN Male</p>	PRICE		1-24	\$58.87	25-49	\$54.75	50-99	\$50.63	100 +	\$47.10	 <table border="1"> <thead> <tr> <th colspan="2">PRICE</th> </tr> </thead> <tbody> <tr> <td>1-24</td> <td>\$47.12</td> </tr> <tr> <td>25-49</td> <td>\$43.82</td> </tr> <tr> <td>50-99</td> <td>\$40.52</td> </tr> <tr> <td>100 +</td> <td>\$37.70</td> </tr> </tbody> </table> <p>Model No: PE9255 SMA Female To HN Female</p>	PRICE		1-24	\$47.12	25-49	\$43.82	50-99	\$40.52	100 +	\$37.70	 <table border="1"> <thead> <tr> <th colspan="2">PRICE</th> </tr> </thead> <tbody> <tr> <td>1-24</td> <td>\$183.26</td> </tr> <tr> <td>25-49</td> <td>\$170.43</td> </tr> <tr> <td>50-99</td> <td>\$157.60</td> </tr> <tr> <td>100 +</td> <td>\$146.61</td> </tr> </tbody> </table> <p>PRECISION Model No: PE9215 SMA Male To 7mm Max VSWR 1.15:1 @ 18 GHz</p>	PRICE		1-24	\$183.26	25-49	\$170.43	50-99	\$157.60	100 +	\$146.61	 <table border="1"> <thead> <tr> <th colspan="2">PRICE</th> </tr> </thead> <tbody> <tr> <td>1-24</td> <td>\$162.08</td> </tr> <tr> <td>25-49</td> <td>\$150.73</td> </tr> <tr> <td>50-99</td> <td>\$139.39</td> </tr> <tr> <td>100 +</td> <td>\$129.66</td> </tr> </tbody> </table> <p>PRECISION Model No: PE9214 SMA Female To 7mm Max VSWR 1.15:1 @ 18 GHz</p>	PRICE		1-24	\$162.08	25-49	\$150.73	50-99	\$139.39	100 +	\$129.66
	PRICE																																											
1-24	\$58.87																																											
25-49	\$54.75																																											
50-99	\$50.63																																											
100 +	\$47.10																																											
PRICE																																												
1-24	\$47.12																																											
25-49	\$43.82																																											
50-99	\$40.52																																											
100 +	\$37.70																																											
PRICE																																												
1-24	\$183.26																																											
25-49	\$170.43																																											
50-99	\$157.60																																											
100 +	\$146.61																																											
PRICE																																												
1-24	\$162.08																																											
25-49	\$150.73																																											
50-99	\$139.39																																											
100 +	\$129.66																																											
4	 <table border="1"> <thead> <tr> <th colspan="2">PRICE</th> </tr> </thead> <tbody> <tr> <td>1-24</td> <td>\$405.17</td> </tr> <tr> <td>25-49</td> <td>\$376.81</td> </tr> <tr> <td>50-99</td> <td>\$348.45</td> </tr> <tr> <td>100 +</td> <td>\$324.14</td> </tr> </tbody> </table> <p>PRECISION Model No: PE9327 SMA Female To 7mm Panel Mount Max VSWR 1.15:1 @ 18 GHz Mounting Hole A05</p>	PRICE		1-24	\$405.17	25-49	\$376.81	50-99	\$348.45	100 +	\$324.14	 <table border="1"> <thead> <tr> <th colspan="2">PRICE</th> </tr> </thead> <tbody> <tr> <td>1-24</td> <td>\$44.28</td> </tr> <tr> <td>25-49</td> <td>\$41.18</td> </tr> <tr> <td>50-99</td> <td>\$38.08</td> </tr> <tr> <td>100 +</td> <td>\$35.42</td> </tr> </tbody> </table> <p>Model No: PE9786 SMA Female To QMA Male</p>	PRICE		1-24	\$44.28	25-49	\$41.18	50-99	\$38.08	100 +	\$35.42	 <table border="1"> <thead> <tr> <th colspan="2">PRICE</th> </tr> </thead> <tbody> <tr> <td>1-24</td> <td>\$92.56</td> </tr> <tr> <td>25-49</td> <td>\$86.08</td> </tr> <tr> <td>50-99</td> <td>\$79.60</td> </tr> <tr> <td>100 +</td> <td>\$74.05</td> </tr> </tbody> </table> <p>PRECISION Model No: PE9511 SMA Male To SMP Male Max VSWR 1.20:1 @ 18 GHz</p>	PRICE		1-24	\$92.56	25-49	\$86.08	50-99	\$79.60	100 +	\$74.05	 <table border="1"> <thead> <tr> <th colspan="2">PRICE</th> </tr> </thead> <tbody> <tr> <td>1-24</td> <td>\$105.89</td> </tr> <tr> <td>25-49</td> <td>\$98.48</td> </tr> <tr> <td>50-99</td> <td>\$91.07</td> </tr> <tr> <td>100 +</td> <td>\$84.71</td> </tr> </tbody> </table> <p>PRECISION Model No: PE9513 SMA Male To SMP Female Max VSWR 1.20:1 @ 18 GHz</p>	PRICE		1-24	\$105.89	25-49	\$98.48	50-99	\$91.07	100 +	\$84.71
	PRICE																																											
1-24	\$405.17																																											
25-49	\$376.81																																											
50-99	\$348.45																																											
100 +	\$324.14																																											
PRICE																																												
1-24	\$44.28																																											
25-49	\$41.18																																											
50-99	\$38.08																																											
100 +	\$35.42																																											
PRICE																																												
1-24	\$92.56																																											
25-49	\$86.08																																											
50-99	\$79.60																																											
100 +	\$74.05																																											
PRICE																																												
1-24	\$105.89																																											
25-49	\$98.48																																											
50-99	\$91.07																																											
100 +	\$84.71																																											
5	 <table border="1"> <thead> <tr> <th colspan="2">PRICE</th> </tr> </thead> <tbody> <tr> <td>1-24</td> <td>\$106.04</td> </tr> <tr> <td>25-49</td> <td>\$98.62</td> </tr> <tr> <td>50-99</td> <td>\$91.19</td> </tr> <tr> <td>100 +</td> <td>\$84.83</td> </tr> </tbody> </table> <p>PRECISION Model No: PE9512 SMA Female To SMP Male Max VSWR 1.20:1 @ 18 GHz</p>	PRICE		1-24	\$106.04	25-49	\$98.62	50-99	\$91.19	100 +	\$84.83	 <table border="1"> <thead> <tr> <th colspan="2">PRICE</th> </tr> </thead> <tbody> <tr> <td>1-24</td> <td>\$294.31</td> </tr> <tr> <td>25-49</td> <td>\$273.71</td> </tr> <tr> <td>50-99</td> <td>\$253.11</td> </tr> <tr> <td>100 +</td> <td>\$235.45</td> </tr> </tbody> </table> <p>PRECISION Model No: PE9778 SMA Female To SMP Male Max VSWR 1.45:1 @ 26.5 GHz</p>	PRICE		1-24	\$294.31	25-49	\$273.71	50-99	\$253.11	100 +	\$235.45	 <table border="1"> <thead> <tr> <th colspan="2">PRICE</th> </tr> </thead> <tbody> <tr> <td>1-24</td> <td>\$158.94</td> </tr> <tr> <td>25-49</td> <td>\$147.81</td> </tr> <tr> <td>50-99</td> <td>\$136.69</td> </tr> <tr> <td>100 +</td> <td>\$127.15</td> </tr> </tbody> </table> <p>PRECISION Model No: PE9779 SMA Female To SMP Female Max VSWR 1.30:1 @ 18 GHz</p>	PRICE		1-24	\$158.94	25-49	\$147.81	50-99	\$136.69	100 +	\$127.15	 <table border="1"> <thead> <tr> <th colspan="2">PRICE</th> </tr> </thead> <tbody> <tr> <td>1-24</td> <td>\$17.12</td> </tr> <tr> <td>25-49</td> <td>\$15.92</td> </tr> <tr> <td>50-99</td> <td>\$14.72</td> </tr> <tr> <td>100 +</td> <td>\$13.70</td> </tr> </tbody> </table> <p>NEW Model No: PE91007 SMA Male To UMCX Jack</p>	PRICE		1-24	\$17.12	25-49	\$15.92	50-99	\$14.72	100 +	\$13.70
	PRICE																																											
1-24	\$106.04																																											
25-49	\$98.62																																											
50-99	\$91.19																																											
100 +	\$84.83																																											
PRICE																																												
1-24	\$294.31																																											
25-49	\$273.71																																											
50-99	\$253.11																																											
100 +	\$235.45																																											
PRICE																																												
1-24	\$158.94																																											
25-49	\$147.81																																											
50-99	\$136.69																																											
100 +	\$127.15																																											
PRICE																																												
1-24	\$17.12																																											
25-49	\$15.92																																											
50-99	\$14.72																																											
100 +	\$13.70																																											
6	 <table border="1"> <thead> <tr> <th colspan="2">PRICE</th> </tr> </thead> <tbody> <tr> <td>1-24</td> <td>\$17.12</td> </tr> <tr> <td>25-49</td> <td>\$15.92</td> </tr> <tr> <td>50-99</td> <td>\$14.72</td> </tr> <tr> <td>100 +</td> <td>\$13.70</td> </tr> </tbody> </table> <p>NEW Model No: PE91005 SMA Female To UMCX Plug</p>	PRICE		1-24	\$17.12	25-49	\$15.92	50-99	\$14.72	100 +	\$13.70	 <table border="1"> <thead> <tr> <th colspan="2">PRICE</th> </tr> </thead> <tbody> <tr> <td>1-24</td> <td>\$17.12</td> </tr> <tr> <td>25-49</td> <td>\$15.92</td> </tr> <tr> <td>50-99</td> <td>\$14.72</td> </tr> <tr> <td>100 +</td> <td>\$13.70</td> </tr> </tbody> </table> <p>NEW Model No: PE91006 SMA Female To UMCX Jack</p>	PRICE		1-24	\$17.12	25-49	\$15.92	50-99	\$14.72	100 +	\$13.70	 <table border="1"> <thead> <tr> <th colspan="2">PRICE</th> </tr> </thead> <tbody> <tr> <td>1-24</td> <td>\$77.47</td> </tr> <tr> <td>25-49</td> <td>\$72.05</td> </tr> <tr> <td>50-99</td> <td>\$66.62</td> </tr> <tr> <td>100 +</td> <td>\$61.98</td> </tr> </tbody> </table> <p>Model No: PE9476 SMA Male To MMCX Plug</p>	PRICE		1-24	\$77.47	25-49	\$72.05	50-99	\$66.62	100 +	\$61.98	 <table border="1"> <thead> <tr> <th colspan="2">PRICE</th> </tr> </thead> <tbody> <tr> <td>1-24</td> <td>\$61.66</td> </tr> <tr> <td>25-49</td> <td>\$57.34</td> </tr> <tr> <td>50-99</td> <td>\$53.03</td> </tr> <tr> <td>100 +</td> <td>\$49.33</td> </tr> </tbody> </table> <p>Model No: PE9478 SMA Male To MMCX Jack</p>	PRICE		1-24	\$61.66	25-49	\$57.34	50-99	\$53.03	100 +	\$49.33
	PRICE																																											
1-24	\$17.12																																											
25-49	\$15.92																																											
50-99	\$14.72																																											
100 +	\$13.70																																											
PRICE																																												
1-24	\$17.12																																											
25-49	\$15.92																																											
50-99	\$14.72																																											
100 +	\$13.70																																											
PRICE																																												
1-24	\$77.47																																											
25-49	\$72.05																																											
50-99	\$66.62																																											
100 +	\$61.98																																											
PRICE																																												
1-24	\$61.66																																											
25-49	\$57.34																																											
50-99	\$53.03																																											
100 +	\$49.33																																											











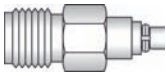
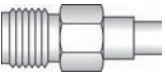
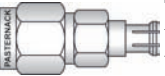

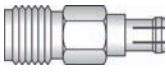





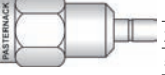

Adapters

See Our Website For Real-Time Stock Availability!

ADAPTERS

See Adapter Locator on Pages 140-145 or the Adapter Matrix on Pages 138-139

See Page 246 for Mounting Holes

	A	B	C	D																																								
1	 <table border="1"> <thead> <tr> <th colspan="2">PRICE</th> </tr> </thead> <tbody> <tr> <td>1-24</td> <td>\$64.46</td> </tr> <tr> <td>25-49</td> <td>\$59.95</td> </tr> <tr> <td>50-99</td> <td>\$55.44</td> </tr> <tr> <td>100 +</td> <td>\$51.57</td> </tr> </tbody> </table> <p>Model No: PE9475 SMA Female To MMCX Plug</p>	PRICE		1-24	\$64.46	25-49	\$59.95	50-99	\$55.44	100 +	\$51.57	 <table border="1"> <thead> <tr> <th colspan="2">PRICE</th> </tr> </thead> <tbody> <tr> <td>1-24</td> <td>\$62.72</td> </tr> <tr> <td>25-49</td> <td>\$58.33</td> </tr> <tr> <td>50-99</td> <td>\$53.94</td> </tr> <tr> <td>100 +</td> <td>\$50.18</td> </tr> </tbody> </table> <p>Model No: PE9477 SMA Female To MMCX Jack</p>	PRICE		1-24	\$62.72	25-49	\$58.33	50-99	\$53.94	100 +	\$50.18	 <table border="1"> <thead> <tr> <th colspan="2">PRICE</th> </tr> </thead> <tbody> <tr> <td>1-24</td> <td>\$58.87</td> </tr> <tr> <td>25-49</td> <td>\$54.75</td> </tr> <tr> <td>50-99</td> <td>\$50.63</td> </tr> <tr> <td>100 +</td> <td>\$47.10</td> </tr> </tbody> </table> <p>Model No: PE9473 SMA Male To MCX Plug</p>	PRICE		1-24	\$58.87	25-49	\$54.75	50-99	\$50.63	100 +	\$47.10	 <table border="1"> <thead> <tr> <th colspan="2">PRICE</th> </tr> </thead> <tbody> <tr> <td>1-24</td> <td>\$71.84</td> </tr> <tr> <td>25-49</td> <td>\$66.81</td> </tr> <tr> <td>50-99</td> <td>\$61.78</td> </tr> <tr> <td>100 +</td> <td>\$57.47</td> </tr> </tbody> </table> <p>Model No: PE9472 SMA Male To MCX Jack</p>	PRICE		1-24	\$71.84	25-49	\$66.81	50-99	\$61.78	100 +	\$57.47
	PRICE																																											
	1-24	\$64.46																																										
	25-49	\$59.95																																										
	50-99	\$55.44																																										
	100 +	\$51.57																																										
PRICE																																												
1-24	\$62.72																																											
25-49	\$58.33																																											
50-99	\$53.94																																											
100 +	\$50.18																																											
PRICE																																												
1-24	\$58.87																																											
25-49	\$54.75																																											
50-99	\$50.63																																											
100 +	\$47.10																																											
PRICE																																												
1-24	\$71.84																																											
25-49	\$66.81																																											
50-99	\$61.78																																											
100 +	\$57.47																																											
2	 <table border="1"> <thead> <tr> <th colspan="2">PRICE</th> </tr> </thead> <tbody> <tr> <td>1-24</td> <td>\$57.10</td> </tr> <tr> <td>25-49</td> <td>\$53.10</td> </tr> <tr> <td>50-99</td> <td>\$49.11</td> </tr> <tr> <td>100 +</td> <td>\$45.68</td> </tr> </tbody> </table> <p>Model No: PE9471 SMA Female To MCX Plug</p>	PRICE		1-24	\$57.10	25-49	\$53.10	50-99	\$49.11	100 +	\$45.68	 <table border="1"> <thead> <tr> <th colspan="2">PRICE</th> </tr> </thead> <tbody> <tr> <td>1-24</td> <td>\$49.65</td> </tr> <tr> <td>25-49</td> <td>\$46.17</td> </tr> <tr> <td>50-99</td> <td>\$42.70</td> </tr> <tr> <td>100 +</td> <td>\$39.72</td> </tr> </tbody> </table> <p>Model No: PE9470 SMA Female To MCX Jack</p>	PRICE		1-24	\$49.65	25-49	\$46.17	50-99	\$42.70	100 +	\$39.72	 <table border="1"> <thead> <tr> <th colspan="2">PRICE</th> </tr> </thead> <tbody> <tr> <td>1-24</td> <td>\$65.16</td> </tr> <tr> <td>25-49</td> <td>\$60.60</td> </tr> <tr> <td>50-99</td> <td>\$56.04</td> </tr> <tr> <td>100 +</td> <td>\$52.13</td> </tr> </tbody> </table> <p>Model No: PE9581 SMA Male To Reverse Polarity MCX Plug</p>	PRICE		1-24	\$65.16	25-49	\$60.60	50-99	\$56.04	100 +	\$52.13	 <table border="1"> <thead> <tr> <th colspan="2">PRICE</th> </tr> </thead> <tbody> <tr> <td>1-24</td> <td>\$74.02</td> </tr> <tr> <td>25-49</td> <td>\$68.84</td> </tr> <tr> <td>50-99</td> <td>\$63.66</td> </tr> <tr> <td>100 +</td> <td>\$59.22</td> </tr> </tbody> </table> <p>Model No: PE9144 SMA Male To SMB Plug</p>	PRICE		1-24	\$74.02	25-49	\$68.84	50-99	\$63.66	100 +	\$59.22
	PRICE																																											
	1-24	\$57.10																																										
	25-49	\$53.10																																										
	50-99	\$49.11																																										
	100 +	\$45.68																																										
PRICE																																												
1-24	\$49.65																																											
25-49	\$46.17																																											
50-99	\$42.70																																											
100 +	\$39.72																																											
PRICE																																												
1-24	\$65.16																																											
25-49	\$60.60																																											
50-99	\$56.04																																											
100 +	\$52.13																																											
PRICE																																												
1-24	\$74.02																																											
25-49	\$68.84																																											
50-99	\$63.66																																											
100 +	\$59.22																																											
3	 <table border="1"> <thead> <tr> <th colspan="2">PRICE</th> </tr> </thead> <tbody> <tr> <td>1-24</td> <td>\$39.06</td> </tr> <tr> <td>25-49</td> <td>\$36.33</td> </tr> <tr> <td>50-99</td> <td>\$33.59</td> </tr> <tr> <td>100 +</td> <td>\$31.25</td> </tr> </tbody> </table> <p>Model No: PE9145 SMA Male To SMB Jack</p>	PRICE		1-24	\$39.06	25-49	\$36.33	50-99	\$33.59	100 +	\$31.25	 <table border="1"> <thead> <tr> <th colspan="2">PRICE</th> </tr> </thead> <tbody> <tr> <td>1-24</td> <td>\$41.54</td> </tr> <tr> <td>25-49</td> <td>\$38.63</td> </tr> <tr> <td>50-99</td> <td>\$35.72</td> </tr> <tr> <td>100 +</td> <td>\$33.23</td> </tr> </tbody> </table> <p>Model No: PE9142 SMA Female To SMB Plug</p>	PRICE		1-24	\$41.54	25-49	\$38.63	50-99	\$35.72	100 +	\$33.23	 <table border="1"> <thead> <tr> <th colspan="2">PRICE</th> </tr> </thead> <tbody> <tr> <td>1-24</td> <td>\$39.06</td> </tr> <tr> <td>25-49</td> <td>\$36.33</td> </tr> <tr> <td>50-99</td> <td>\$33.59</td> </tr> <tr> <td>100 +</td> <td>\$31.25</td> </tr> </tbody> </table> <p>Model No: PE9143 SMA Female To SMB Jack</p>	PRICE		1-24	\$39.06	25-49	\$36.33	50-99	\$33.59	100 +	\$31.25	 <table border="1"> <thead> <tr> <th colspan="2">PRICE</th> </tr> </thead> <tbody> <tr> <td>1-24</td> <td>\$63.69</td> </tr> <tr> <td>25-49</td> <td>\$59.23</td> </tr> <tr> <td>50-99</td> <td>\$54.77</td> </tr> <tr> <td>100 +</td> <td>\$50.95</td> </tr> </tbody> </table> <p>Model No: PE9401 SMA Male To SSMB Jack</p>	PRICE		1-24	\$63.69	25-49	\$59.23	50-99	\$54.77	100 +	\$50.95
	PRICE																																											
	1-24	\$39.06																																										
	25-49	\$36.33																																										
	50-99	\$33.59																																										
	100 +	\$31.25																																										
PRICE																																												
1-24	\$41.54																																											
25-49	\$38.63																																											
50-99	\$35.72																																											
100 +	\$33.23																																											
PRICE																																												
1-24	\$39.06																																											
25-49	\$36.33																																											
50-99	\$33.59																																											
100 +	\$31.25																																											
PRICE																																												
1-24	\$63.69																																											
25-49	\$59.23																																											
50-99	\$54.77																																											
100 +	\$50.95																																											
4	 <table border="1"> <thead> <tr> <th colspan="2">PRICE</th> </tr> </thead> <tbody> <tr> <td>1-24</td> <td>\$46.21</td> </tr> <tr> <td>25-49</td> <td>\$42.98</td> </tr> <tr> <td>50-99</td> <td>\$39.74</td> </tr> <tr> <td>100 +</td> <td>\$36.97</td> </tr> </tbody> </table> <p>Model No: PE9402 SMA Female To SSMB Plug</p>	PRICE		1-24	\$46.21	25-49	\$42.98	50-99	\$39.74	100 +	\$36.97	 <table border="1"> <thead> <tr> <th colspan="2">PRICE</th> </tr> </thead> <tbody> <tr> <td>1-24</td> <td>\$64.70</td> </tr> <tr> <td>25-49</td> <td>\$60.17</td> </tr> <tr> <td>50-99</td> <td>\$55.64</td> </tr> <tr> <td>100 +</td> <td>\$51.76</td> </tr> </tbody> </table> <p>Model No: PE9692 SMA Male To 1.0/2.3 Slide On Plug</p>	PRICE		1-24	\$64.70	25-49	\$60.17	50-99	\$55.64	100 +	\$51.76	 <table border="1"> <thead> <tr> <th colspan="2">PRICE</th> </tr> </thead> <tbody> <tr> <td>1-24</td> <td>\$66.02</td> </tr> <tr> <td>25-49</td> <td>\$61.40</td> </tr> <tr> <td>50-99</td> <td>\$56.78</td> </tr> <tr> <td>100 +</td> <td>\$52.82</td> </tr> </tbody> </table> <p>Model No: PE9690 SMA Male To 1.0/2.3 Slide On Jack</p>	PRICE		1-24	\$66.02	25-49	\$61.40	50-99	\$56.78	100 +	\$52.82	 <table border="1"> <thead> <tr> <th colspan="2">PRICE</th> </tr> </thead> <tbody> <tr> <td>1-24</td> <td>\$63.58</td> </tr> <tr> <td>25-49</td> <td>\$59.13</td> </tr> <tr> <td>50-99</td> <td>\$54.68</td> </tr> <tr> <td>100 +</td> <td>\$50.86</td> </tr> </tbody> </table> <p>Model No: PE9691 SMA Female To 1.0/2.3 Slide On Plug</p>	PRICE		1-24	\$63.58	25-49	\$59.13	50-99	\$54.68	100 +	\$50.86
	PRICE																																											
	1-24	\$46.21																																										
	25-49	\$42.98																																										
	50-99	\$39.74																																										
	100 +	\$36.97																																										
PRICE																																												
1-24	\$64.70																																											
25-49	\$60.17																																											
50-99	\$55.64																																											
100 +	\$51.76																																											
PRICE																																												
1-24	\$66.02																																											
25-49	\$61.40																																											
50-99	\$56.78																																											
100 +	\$52.82																																											
PRICE																																												
1-24	\$63.58																																											
25-49	\$59.13																																											
50-99	\$54.68																																											
100 +	\$50.86																																											
5	 <table border="1"> <thead> <tr> <th colspan="2">PRICE</th> </tr> </thead> <tbody> <tr> <td>1-24</td> <td>\$64.70</td> </tr> <tr> <td>25-49</td> <td>\$60.17</td> </tr> <tr> <td>50-99</td> <td>\$55.64</td> </tr> <tr> <td>100 +</td> <td>\$51.76</td> </tr> </tbody> </table> <p>Model No: PE9693 SMA Female To 1.0/2.3 Slide On Jack</p>	PRICE		1-24	\$64.70	25-49	\$60.17	50-99	\$55.64	100 +	\$51.76	 <table border="1"> <thead> <tr> <th colspan="2">PRICE</th> </tr> </thead> <tbody> <tr> <td>1-24</td> <td>\$57.81</td> </tr> <tr> <td>25-49</td> <td>\$53.76</td> </tr> <tr> <td>50-99</td> <td>\$49.72</td> </tr> <tr> <td>100 +</td> <td>\$46.25</td> </tr> </tbody> </table> <p>PRECISION Model No: PE9493 SMA Male To BNC Male Max VSWR 1.25:1 @ 8 GHz</p>	PRICE		1-24	\$57.81	25-49	\$53.76	50-99	\$49.72	100 +	\$46.25	 <table border="1"> <thead> <tr> <th colspan="2">PRICE</th> </tr> </thead> <tbody> <tr> <td>1-24</td> <td>\$30.89</td> </tr> <tr> <td>25-49</td> <td>\$28.73</td> </tr> <tr> <td>50-99</td> <td>\$26.57</td> </tr> <tr> <td>100 +</td> <td>\$24.71</td> </tr> </tbody> </table> <p>Model No: PE9072 SMA Male To BNC Male</p>	PRICE		1-24	\$30.89	25-49	\$28.73	50-99	\$26.57	100 +	\$24.71	 <table border="1"> <thead> <tr> <th colspan="2">PRICE</th> </tr> </thead> <tbody> <tr> <td>1-24</td> <td>\$104.12</td> </tr> <tr> <td>25-49</td> <td>\$96.83</td> </tr> <tr> <td>50-99</td> <td>\$89.54</td> </tr> <tr> <td>100 +</td> <td>\$83.30</td> </tr> </tbody> </table> <p>PRECISION Model No: PE9495 SMA Male To BNC Female Max VSWR 1.25:1 @ 8 GHz</p>	PRICE		1-24	\$104.12	25-49	\$96.83	50-99	\$89.54	100 +	\$83.30
	PRICE																																											
	1-24	\$64.70																																										
	25-49	\$60.17																																										
	50-99	\$55.64																																										
	100 +	\$51.76																																										
PRICE																																												
1-24	\$57.81																																											
25-49	\$53.76																																											
50-99	\$49.72																																											
100 +	\$46.25																																											
PRICE																																												
1-24	\$30.89																																											
25-49	\$28.73																																											
50-99	\$26.57																																											
100 +	\$24.71																																											
PRICE																																												
1-24	\$104.12																																											
25-49	\$96.83																																											
50-99	\$89.54																																											
100 +	\$83.30																																											
6	 <table border="1"> <thead> <tr> <th colspan="2">PRICE</th> </tr> </thead> <tbody> <tr> <td>1-24</td> <td>\$28.88</td> </tr> <tr> <td>25-49</td> <td>\$26.86</td> </tr> <tr> <td>50-99</td> <td>\$24.84</td> </tr> <tr> <td>100 +</td> <td>\$23.10</td> </tr> </tbody> </table> <p>Model No: PE9074 SMA Male To BNC Female</p>	PRICE		1-24	\$28.88	25-49	\$26.86	50-99	\$24.84	100 +	\$23.10	 <table border="1"> <thead> <tr> <th colspan="2">PRICE</th> </tr> </thead> <tbody> <tr> <td>1-24</td> <td>\$52.69</td> </tr> <tr> <td>25-49</td> <td>\$49.00</td> </tr> <tr> <td>50-99</td> <td>\$45.31</td> </tr> <tr> <td>100 +</td> <td>\$42.15</td> </tr> </tbody> </table> <p>PRECISION Model No: PE9494 SMA Female To BNC Male Max VSWR 1.25:1 @ 8 GHz</p>	PRICE		1-24	\$52.69	25-49	\$49.00	50-99	\$45.31	100 +	\$42.15	 <table border="1"> <thead> <tr> <th colspan="2">PRICE</th> </tr> </thead> <tbody> <tr> <td>1-24</td> <td>\$28.88</td> </tr> <tr> <td>25-49</td> <td>\$26.86</td> </tr> <tr> <td>50-99</td> <td>\$24.84</td> </tr> <tr> <td>100 +</td> <td>\$23.10</td> </tr> </tbody> </table> <p>Model No: PE9073 SMA Female To BNC Male</p>	PRICE		1-24	\$28.88	25-49	\$26.86	50-99	\$24.84	100 +	\$23.10	 <table border="1"> <thead> <tr> <th colspan="2">PRICE</th> </tr> </thead> <tbody> <tr> <td>1-24</td> <td>\$57.81</td> </tr> <tr> <td>25-49</td> <td>\$53.76</td> </tr> <tr> <td>50-99</td> <td>\$49.72</td> </tr> <tr> <td>100 +</td> <td>\$46.25</td> </tr> </tbody> </table> <p>PRECISION Model No: PE9496 SMA Female To BNC Female Max VSWR 1.25:1 @ 8 GHz</p>	PRICE		1-24	\$57.81	25-49	\$53.76	50-99	\$49.72	100 +	\$46.25
	PRICE																																											
	1-24	\$28.88																																										
	25-49	\$26.86																																										
	50-99	\$24.84																																										
	100 +	\$23.10																																										
PRICE																																												
1-24	\$52.69																																											
25-49	\$49.00																																											
50-99	\$45.31																																											
100 +	\$42.15																																											
PRICE																																												
1-24	\$28.88																																											
25-49	\$26.86																																											
50-99	\$24.84																																											
100 +	\$23.10																																											
PRICE																																												
1-24	\$57.81																																											
25-49	\$53.76																																											
50-99	\$49.72																																											
100 +	\$46.25																																											















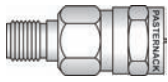



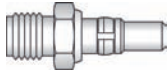

Adapters

See Our Website For Real-Time Stock Availability!

ADAPTERS

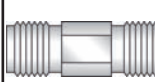
See Adapter Locator on Pages 140-145 or the Adapter Matrix on Pages 138-139

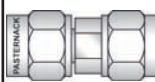
See Page 246 for Mounting Holes

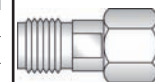
	A	B	C	D																																								
1	 <table border="1"> <thead> <tr> <th colspan="2">PRICE</th> </tr> </thead> <tbody> <tr> <td>1-24</td> <td>\$32.83</td> </tr> <tr> <td>25-49</td> <td>\$30.53</td> </tr> <tr> <td>50-99</td> <td>\$28.23</td> </tr> <tr> <td>100 +</td> <td>\$26.26</td> </tr> </tbody> </table> <p>Model No: PE9075 SMA Female To BNC Female</p>	PRICE		1-24	\$32.83	25-49	\$30.53	50-99	\$28.23	100 +	\$26.26	 <table border="1"> <thead> <tr> <th colspan="2">PRICE</th> </tr> </thead> <tbody> <tr> <td>1-24</td> <td>\$40.13</td> </tr> <tr> <td>25-49</td> <td>\$37.32</td> </tr> <tr> <td>50-99</td> <td>\$34.51</td> </tr> <tr> <td>100 +</td> <td>\$32.10</td> </tr> </tbody> </table> <p>Model No: PE9185 SMA Female To BNC Female Bulkhead Mounting Hole B06</p>	PRICE		1-24	\$40.13	25-49	\$37.32	50-99	\$34.51	100 +	\$32.10	 <table border="1"> <thead> <tr> <th colspan="2">PRICE</th> </tr> </thead> <tbody> <tr> <td>1-24</td> <td>\$47.88</td> </tr> <tr> <td>25-49</td> <td>\$44.53</td> </tr> <tr> <td>50-99</td> <td>\$41.18</td> </tr> <tr> <td>100 +</td> <td>\$38.30</td> </tr> </tbody> </table> <p>Model No: PE9407 SMA Female Bulkhead To BNC Female, Nut On SMA Mounting Hole B04</p>	PRICE		1-24	\$47.88	25-49	\$44.53	50-99	\$41.18	100 +	\$38.30	 <table border="1"> <thead> <tr> <th colspan="2">PRICE</th> </tr> </thead> <tbody> <tr> <td>1-24</td> <td>\$53.70</td> </tr> <tr> <td>25-49</td> <td>\$49.94</td> </tr> <tr> <td>50-99</td> <td>\$46.18</td> </tr> <tr> <td>100 +</td> <td>\$42.96</td> </tr> </tbody> </table> <p>NEW Model No: PE91003 50 Ohm SMA Male To F Female</p>	PRICE		1-24	\$53.70	25-49	\$49.94	50-99	\$46.18	100 +	\$42.96
PRICE																																												
1-24	\$32.83																																											
25-49	\$30.53																																											
50-99	\$28.23																																											
100 +	\$26.26																																											
PRICE																																												
1-24	\$40.13																																											
25-49	\$37.32																																											
50-99	\$34.51																																											
100 +	\$32.10																																											
PRICE																																												
1-24	\$47.88																																											
25-49	\$44.53																																											
50-99	\$41.18																																											
100 +	\$38.30																																											
PRICE																																												
1-24	\$53.70																																											
25-49	\$49.94																																											
50-99	\$46.18																																											
100 +	\$42.96																																											
2	 <table border="1"> <thead> <tr> <th colspan="2">PRICE</th> </tr> </thead> <tbody> <tr> <td>1-24</td> <td>\$53.70</td> </tr> <tr> <td>25-49</td> <td>\$49.94</td> </tr> <tr> <td>50-99</td> <td>\$46.18</td> </tr> <tr> <td>100 +</td> <td>\$42.96</td> </tr> </tbody> </table> <p>NEW Model No: PE91001 50 Ohm SMA Female To F Male</p>	PRICE		1-24	\$53.70	25-49	\$49.94	50-99	\$46.18	100 +	\$42.96	 <table border="1"> <thead> <tr> <th colspan="2">PRICE</th> </tr> </thead> <tbody> <tr> <td>1-24</td> <td>\$51.53</td> </tr> <tr> <td>25-49</td> <td>\$47.92</td> </tr> <tr> <td>50-99</td> <td>\$44.32</td> </tr> <tr> <td>100 +</td> <td>\$41.22</td> </tr> </tbody> </table> <p>NEW Model No: PE91002 50 Ohm SMA Female To F Female</p>	PRICE		1-24	\$51.53	25-49	\$47.92	50-99	\$44.32	100 +	\$41.22	 <table border="1"> <thead> <tr> <th colspan="2">PRICE</th> </tr> </thead> <tbody> <tr> <td>1-24</td> <td>\$23.51</td> </tr> <tr> <td>25-49</td> <td>\$21.86</td> </tr> <tr> <td>50-99</td> <td>\$20.22</td> </tr> <tr> <td>100 +</td> <td>\$18.81</td> </tr> </tbody> </table> <p>Model No: PE9425 SMA Male To D Subminiature Plug</p>	PRICE		1-24	\$23.51	25-49	\$21.86	50-99	\$20.22	100 +	\$18.81	 <table border="1"> <thead> <tr> <th colspan="2">PRICE</th> </tr> </thead> <tbody> <tr> <td>1-24</td> <td>\$23.51</td> </tr> <tr> <td>25-49</td> <td>\$21.86</td> </tr> <tr> <td>50-99</td> <td>\$20.22</td> </tr> <tr> <td>100 +</td> <td>\$18.81</td> </tr> </tbody> </table> <p>Model No: PE9424 SMA Male To D Subminiature Receptacle</p>	PRICE		1-24	\$23.51	25-49	\$21.86	50-99	\$20.22	100 +	\$18.81
PRICE																																												
1-24	\$53.70																																											
25-49	\$49.94																																											
50-99	\$46.18																																											
100 +	\$42.96																																											
PRICE																																												
1-24	\$51.53																																											
25-49	\$47.92																																											
50-99	\$44.32																																											
100 +	\$41.22																																											
PRICE																																												
1-24	\$23.51																																											
25-49	\$21.86																																											
50-99	\$20.22																																											
100 +	\$18.81																																											
PRICE																																												
1-24	\$23.51																																											
25-49	\$21.86																																											
50-99	\$20.22																																											
100 +	\$18.81																																											
3	 <table border="1"> <thead> <tr> <th colspan="2">PRICE</th> </tr> </thead> <tbody> <tr> <td>1-24</td> <td>\$23.51</td> </tr> <tr> <td>25-49</td> <td>\$21.86</td> </tr> <tr> <td>50-99</td> <td>\$20.22</td> </tr> <tr> <td>100 +</td> <td>\$18.81</td> </tr> </tbody> </table> <p>Model No: PE9422 SMA Female To D Subminiature Plug</p>	PRICE		1-24	\$23.51	25-49	\$21.86	50-99	\$20.22	100 +	\$18.81	 <table border="1"> <thead> <tr> <th colspan="2">PRICE</th> </tr> </thead> <tbody> <tr> <td>1-24</td> <td>\$23.51</td> </tr> <tr> <td>25-49</td> <td>\$21.86</td> </tr> <tr> <td>50-99</td> <td>\$20.22</td> </tr> <tr> <td>100 +</td> <td>\$18.81</td> </tr> </tbody> </table> <p>Model No: PE9423 SMA Female To D Subminiature Receptacle</p>	PRICE		1-24	\$23.51	25-49	\$21.86	50-99	\$20.22	100 +	\$18.81	 <table border="1"> <thead> <tr> <th colspan="2">PRICE</th> </tr> </thead> <tbody> <tr> <td>1-24</td> <td>\$130.36</td> </tr> <tr> <td>25-49</td> <td>\$121.23</td> </tr> <tr> <td>50-99</td> <td>\$112.11</td> </tr> <tr> <td>100 +</td> <td>\$104.29</td> </tr> </tbody> </table> <p>Model No: PE9259 SMA Male To GR874</p>	PRICE		1-24	\$130.36	25-49	\$121.23	50-99	\$112.11	100 +	\$104.29	 <table border="1"> <thead> <tr> <th colspan="2">PRICE</th> </tr> </thead> <tbody> <tr> <td>1-24</td> <td>\$130.36</td> </tr> <tr> <td>25-49</td> <td>\$121.23</td> </tr> <tr> <td>50-99</td> <td>\$112.11</td> </tr> <tr> <td>100 +</td> <td>\$104.29</td> </tr> </tbody> </table> <p>Model No: PE9260 SMA Female To GR874</p>	PRICE		1-24	\$130.36	25-49	\$121.23	50-99	\$112.11	100 +	\$104.29
PRICE																																												
1-24	\$23.51																																											
25-49	\$21.86																																											
50-99	\$20.22																																											
100 +	\$18.81																																											
PRICE																																												
1-24	\$23.51																																											
25-49	\$21.86																																											
50-99	\$20.22																																											
100 +	\$18.81																																											
PRICE																																												
1-24	\$130.36																																											
25-49	\$121.23																																											
50-99	\$112.11																																											
100 +	\$104.29																																											
PRICE																																												
1-24	\$130.36																																											
25-49	\$121.23																																											
50-99	\$112.11																																											
100 +	\$104.29																																											
4	<p>3.5mm In-Series</p> <p>→</p>	 <table border="1"> <thead> <tr> <th colspan="2">PRICE</th> </tr> </thead> <tbody> <tr> <td>1-24</td> <td>\$150.42</td> </tr> <tr> <td>25-49</td> <td>\$139.89</td> </tr> <tr> <td>50-99</td> <td>\$129.36</td> </tr> <tr> <td>100 +</td> <td>\$120.34</td> </tr> </tbody> </table> <p>PRECISION Model No: PE9330 3.5mm Male To 3.5mm Male Bulkhead, Mounting Hole B05 Max VSWR 1.15:1 @ 26.5 GHz</p>	PRICE		1-24	\$150.42	25-49	\$139.89	50-99	\$129.36	100 +	\$120.34	 <table border="1"> <thead> <tr> <th colspan="2">PRICE</th> </tr> </thead> <tbody> <tr> <td>1-24</td> <td>\$223.69</td> </tr> <tr> <td>25-49</td> <td>\$208.03</td> </tr> <tr> <td>50-99</td> <td>\$192.37</td> </tr> <tr> <td>100 +</td> <td>\$178.95</td> </tr> </tbody> </table> <p>PRECISION Model No: PE9679 3.5mm Male To 3.5mm Male Bulkhead, Mounting Hole B05 Max VSWR 1.25:1 @ 34 GHz</p>	PRICE		1-24	\$223.69	25-49	\$208.03	50-99	\$192.37	100 +	\$178.95	 <table border="1"> <thead> <tr> <th colspan="2">PRICE</th> </tr> </thead> <tbody> <tr> <td>1-24</td> <td>\$150.42</td> </tr> <tr> <td>25-49</td> <td>\$139.89</td> </tr> <tr> <td>50-99</td> <td>\$129.36</td> </tr> <tr> <td>100 +</td> <td>\$120.34</td> </tr> </tbody> </table> <p>PRECISION Model No: PE9332 3.5mm Male To 3.5mm Female Bulkhead, Mounting Hole B05 Max VSWR 1.15:1 @ 26.5 GHz</p>	PRICE		1-24	\$150.42	25-49	\$139.89	50-99	\$129.36	100 +	\$120.34										
PRICE																																												
1-24	\$150.42																																											
25-49	\$139.89																																											
50-99	\$129.36																																											
100 +	\$120.34																																											
PRICE																																												
1-24	\$223.69																																											
25-49	\$208.03																																											
50-99	\$192.37																																											
100 +	\$178.95																																											
PRICE																																												
1-24	\$150.42																																											
25-49	\$139.89																																											
50-99	\$129.36																																											
100 +	\$120.34																																											
5	 <table border="1"> <thead> <tr> <th colspan="2">PRICE</th> </tr> </thead> <tbody> <tr> <td>1-24</td> <td>\$141.25</td> </tr> <tr> <td>25-49</td> <td>\$131.36</td> </tr> <tr> <td>50-99</td> <td>\$121.48</td> </tr> <tr> <td>100 +</td> <td>\$113.00</td> </tr> </tbody> </table> <p>PRECISION Model No: PE9677 3.5mm Male To 3.5mm Female Bulkhead, Mounting Hole B09 Max VSWR 1.25:1 @ 34 GHz</p>	PRICE		1-24	\$141.25	25-49	\$131.36	50-99	\$121.48	100 +	\$113.00	 <table border="1"> <thead> <tr> <th colspan="2">PRICE</th> </tr> </thead> <tbody> <tr> <td>1-24</td> <td>\$116.07</td> </tr> <tr> <td>25-49</td> <td>\$107.95</td> </tr> <tr> <td>50-99</td> <td>\$99.82</td> </tr> <tr> <td>100 +</td> <td>\$92.86</td> </tr> </tbody> </table> <p>PRECISION Model No: PE9331 3.5mm Female To 3.5mm Female Bulkhead, Mounting Hole B09 Max VSWR 1.15:1 @ 26.5 GHz</p>	PRICE		1-24	\$116.07	25-49	\$107.95	50-99	\$99.82	100 +	\$92.86	 <table border="1"> <thead> <tr> <th colspan="2">PRICE</th> </tr> </thead> <tbody> <tr> <td>1-24</td> <td>\$129.45</td> </tr> <tr> <td>25-49</td> <td>\$120.39</td> </tr> <tr> <td>50-99</td> <td>\$111.33</td> </tr> <tr> <td>100 +</td> <td>\$103.56</td> </tr> </tbody> </table> <p>PRECISION Model No: PE9678 3.5mm Female To 3.5mm Female Bulkhead, Mounting Hole B09 Max VSWR 1.25:1 @ 34 GHz</p>	PRICE		1-24	\$129.45	25-49	\$120.39	50-99	\$111.33	100 +	\$103.56	 <table border="1"> <thead> <tr> <th colspan="2">PRICE</th> </tr> </thead> <tbody> <tr> <td>1-24</td> <td>\$176.57</td> </tr> <tr> <td>25-49</td> <td>\$164.21</td> </tr> <tr> <td>50-99</td> <td>\$151.85</td> </tr> <tr> <td>100 +</td> <td>\$141.26</td> </tr> </tbody> </table> <p>PRECISION Model No: PE9676 3.5mm Female To 3.5mm Female 4 Hole Panel Mount Mounting Hole A01 Max VSWR 1.25:1 @ 34 GHz</p>	PRICE		1-24	\$176.57	25-49	\$164.21	50-99	\$151.85	100 +	\$141.26
PRICE																																												
1-24	\$141.25																																											
25-49	\$131.36																																											
50-99	\$121.48																																											
100 +	\$113.00																																											
PRICE																																												
1-24	\$116.07																																											
25-49	\$107.95																																											
50-99	\$99.82																																											
100 +	\$92.86																																											
PRICE																																												
1-24	\$129.45																																											
25-49	\$120.39																																											
50-99	\$111.33																																											
100 +	\$103.56																																											
PRICE																																												
1-24	\$176.57																																											
25-49	\$164.21																																											
50-99	\$151.85																																											
100 +	\$141.26																																											
6	<p>3.5mm Between-Series</p> <p>→</p>	 <table border="1"> <thead> <tr> <th colspan="2">PRICE</th> </tr> </thead> <tbody> <tr> <td>1-24</td> <td>\$153.01</td> </tr> <tr> <td>25-49</td> <td>\$142.30</td> </tr> <tr> <td>50-99</td> <td>\$131.59</td> </tr> <tr> <td>100 +</td> <td>\$122.41</td> </tr> </tbody> </table> <p>PRECISION Model No: PE9657 3.5mm Male To 2.92mm Male Max VSWR 1.25:1 @ 34 GHz</p>	PRICE		1-24	\$153.01	25-49	\$142.30	50-99	\$131.59	100 +	\$122.41	 <table border="1"> <thead> <tr> <th colspan="2">PRICE</th> </tr> </thead> <tbody> <tr> <td>1-24</td> <td>\$164.81</td> </tr> <tr> <td>25-49</td> <td>\$153.27</td> </tr> <tr> <td>50-99</td> <td>\$141.74</td> </tr> <tr> <td>100 +</td> <td>\$131.85</td> </tr> </tbody> </table> <p>PRECISION Model No: PE9658 3.5mm Male To 2.92mm Female Max VSWR 1.25:1 @ 34 GHz</p>	PRICE		1-24	\$164.81	25-49	\$153.27	50-99	\$141.74	100 +	\$131.85	 <table border="1"> <thead> <tr> <th colspan="2">PRICE</th> </tr> </thead> <tbody> <tr> <td>1-24</td> <td>\$162.08</td> </tr> <tr> <td>25-49</td> <td>\$150.73</td> </tr> <tr> <td>50-99</td> <td>\$139.39</td> </tr> <tr> <td>100 +</td> <td>\$129.66</td> </tr> </tbody> </table> <p>PRECISION Model No: PE9659 3.5mm Female To 2.92mm Male Max VSWR 1.25:1 @ 34 GHz</p>	PRICE		1-24	\$162.08	25-49	\$150.73	50-99	\$139.39	100 +	\$129.66										
PRICE																																												
1-24	\$153.01																																											
25-49	\$142.30																																											
50-99	\$131.59																																											
100 +	\$122.41																																											
PRICE																																												
1-24	\$164.81																																											
25-49	\$153.27																																											
50-99	\$141.74																																											
100 +	\$131.85																																											
PRICE																																												
1-24	\$162.08																																											
25-49	\$150.73																																											
50-99	\$139.39																																											
100 +	\$129.66																																											

Adapters

See Our Website For Real-Time Stock Availability!











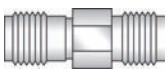

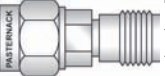
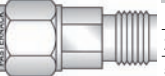
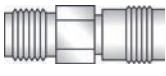

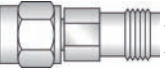
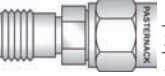
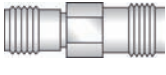
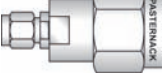

ADAPTERS

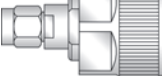
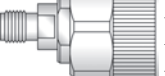
See Adapter Locator on Pages 140-145 or the Adapter Matrix on Pages 138-139

See Page 246 for Mounting Holes

Adapters

See Our Website For Real-Time Stock Availability!











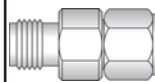
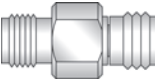
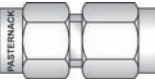
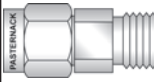
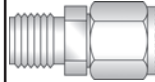
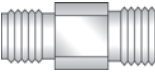

	A	B	C	D																																								
1	 <table border="1"> <thead> <tr> <th colspan="2">PRICE</th> </tr> </thead> <tbody> <tr> <td>1-24</td> <td>\$164.81</td> </tr> <tr> <td>25-49</td> <td>\$153.27</td> </tr> <tr> <td>50-99</td> <td>\$141.74</td> </tr> <tr> <td>100 +</td> <td>\$131.85</td> </tr> </tbody> </table> <p>PRECISION Model No: PE9660 3.5mm Female To 2.92mm Female Max VSWR 1.25:1 @ 34 GHz</p>	PRICE		1-24	\$164.81	25-49	\$153.27	50-99	\$141.74	100 +	\$131.85	 <table border="1"> <thead> <tr> <th colspan="2">PRICE</th> </tr> </thead> <tbody> <tr> <td>1-24</td> <td>\$162.08</td> </tr> <tr> <td>25-49</td> <td>\$150.73</td> </tr> <tr> <td>50-99</td> <td>\$139.39</td> </tr> <tr> <td>100 +</td> <td>\$129.66</td> </tr> </tbody> </table> <p>PRECISION Model No: PE9649 3.5mm Male To 2.4mm Male Max VSWR 1.25:1 @ 34 GHz</p>	PRICE		1-24	\$162.08	25-49	\$150.73	50-99	\$139.39	100 +	\$129.66	 <table border="1"> <thead> <tr> <th colspan="2">PRICE</th> </tr> </thead> <tbody> <tr> <td>1-24</td> <td>\$162.08</td> </tr> <tr> <td>25-49</td> <td>\$150.73</td> </tr> <tr> <td>50-99</td> <td>\$139.39</td> </tr> <tr> <td>100 +</td> <td>\$129.66</td> </tr> </tbody> </table> <p>PRECISION Model No: PE9651 3.5mm Male To 2.4mm Female Max VSWR 1.25:1 @ 34 GHz</p>	PRICE		1-24	\$162.08	25-49	\$150.73	50-99	\$139.39	100 +	\$129.66	 <table border="1"> <thead> <tr> <th colspan="2">PRICE</th> </tr> </thead> <tbody> <tr> <td>1-24</td> <td>\$165.52</td> </tr> <tr> <td>25-49</td> <td>\$153.93</td> </tr> <tr> <td>50-99</td> <td>\$142.35</td> </tr> <tr> <td>100 +</td> <td>\$132.42</td> </tr> </tbody> </table> <p>PRECISION Model No: PE9650 3.5mm Female To 2.4mm Male Max VSWR 1.25:1 @ 34 GHz</p>	PRICE		1-24	\$165.52	25-49	\$153.93	50-99	\$142.35	100 +	\$132.42
	PRICE																																											
1-24	\$164.81																																											
25-49	\$153.27																																											
50-99	\$141.74																																											
100 +	\$131.85																																											
PRICE																																												
1-24	\$162.08																																											
25-49	\$150.73																																											
50-99	\$139.39																																											
100 +	\$129.66																																											
PRICE																																												
1-24	\$162.08																																											
25-49	\$150.73																																											
50-99	\$139.39																																											
100 +	\$129.66																																											
PRICE																																												
1-24	\$165.52																																											
25-49	\$153.93																																											
50-99	\$142.35																																											
100 +	\$132.42																																											
2	 <table border="1"> <thead> <tr> <th colspan="2">PRICE</th> </tr> </thead> <tbody> <tr> <td>1-24</td> <td>\$145.56</td> </tr> <tr> <td>25-49</td> <td>\$135.37</td> </tr> <tr> <td>50-99</td> <td>\$125.18</td> </tr> <tr> <td>100 +</td> <td>\$116.45</td> </tr> </tbody> </table> <p>PRECISION Model No: PE9652 3.5mm Female To 2.4mm Female Max VSWR 1.25:1 @ 34 GHz</p>	PRICE		1-24	\$145.56	25-49	\$135.37	50-99	\$125.18	100 +	\$116.45	 <table border="1"> <thead> <tr> <th colspan="2">PRICE</th> </tr> </thead> <tbody> <tr> <td>1-24</td> <td>\$141.25</td> </tr> <tr> <td>25-49</td> <td>\$131.36</td> </tr> <tr> <td>50-99</td> <td>\$121.48</td> </tr> <tr> <td>100 +</td> <td>\$113.00</td> </tr> </tbody> </table> <p>PRECISION Model No: PE9746 3.5mm Male To 1.85mm Male Max VSWR 1.25:1 @ 34.5 GHz</p>	PRICE		1-24	\$141.25	25-49	\$131.36	50-99	\$121.48	100 +	\$113.00	 <table border="1"> <thead> <tr> <th colspan="2">PRICE</th> </tr> </thead> <tbody> <tr> <td>1-24</td> <td>\$141.25</td> </tr> <tr> <td>25-49</td> <td>\$131.36</td> </tr> <tr> <td>50-99</td> <td>\$121.48</td> </tr> <tr> <td>100 +</td> <td>\$113.00</td> </tr> </tbody> </table> <p>PRECISION Model No: PE9745 3.5mm Male To 1.85mm Female Max VSWR 1.25:1 @ 34.5 GHz</p>	PRICE		1-24	\$141.25	25-49	\$131.36	50-99	\$121.48	100 +	\$113.00	 <table border="1"> <thead> <tr> <th colspan="2">PRICE</th> </tr> </thead> <tbody> <tr> <td>1-24</td> <td>\$141.25</td> </tr> <tr> <td>25-49</td> <td>\$131.36</td> </tr> <tr> <td>50-99</td> <td>\$121.48</td> </tr> <tr> <td>100 +</td> <td>\$113.00</td> </tr> </tbody> </table> <p>PRECISION Model No: PE9747 3.5mm Female To 1.85mm Male Max VSWR 1.25:1 @ 34.5 GHz</p>	PRICE		1-24	\$141.25	25-49	\$131.36	50-99	\$121.48	100 +	\$113.00
	PRICE																																											
1-24	\$145.56																																											
25-49	\$135.37																																											
50-99	\$125.18																																											
100 +	\$116.45																																											
PRICE																																												
1-24	\$141.25																																											
25-49	\$131.36																																											
50-99	\$121.48																																											
100 +	\$113.00																																											
PRICE																																												
1-24	\$141.25																																											
25-49	\$131.36																																											
50-99	\$121.48																																											
100 +	\$113.00																																											
PRICE																																												
1-24	\$141.25																																											
25-49	\$131.36																																											
50-99	\$121.48																																											
100 +	\$113.00																																											
3	 <table border="1"> <thead> <tr> <th colspan="2">PRICE</th> </tr> </thead> <tbody> <tr> <td>1-24</td> <td>\$141.25</td> </tr> <tr> <td>25-49</td> <td>\$131.36</td> </tr> <tr> <td>50-99</td> <td>\$121.48</td> </tr> <tr> <td>100 +</td> <td>\$113.00</td> </tr> </tbody> </table> <p>PRECISION Model No: PE9748 3.5mm Female To 1.85mm Female Max VSWR 1.30:1 @ 34.5 GHz</p>	PRICE		1-24	\$141.25	25-49	\$131.36	50-99	\$121.48	100 +	\$113.00	 <table border="1"> <thead> <tr> <th colspan="2">PRICE</th> </tr> </thead> <tbody> <tr> <td>1-24</td> <td>\$144.60</td> </tr> <tr> <td>25-49</td> <td>\$134.48</td> </tr> <tr> <td>50-99</td> <td>\$124.36</td> </tr> <tr> <td>100 +</td> <td>\$115.68</td> </tr> </tbody> </table> <p>PRECISION Model No: PE9322 3.5mm Male To N Male Max VSWR 1.15:1 @ 18 GHz</p>	PRICE		1-24	\$144.60	25-49	\$134.48	50-99	\$124.36	100 +	\$115.68	 <table border="1"> <thead> <tr> <th colspan="2">PRICE</th> </tr> </thead> <tbody> <tr> <td>1-24</td> <td>\$136.69</td> </tr> <tr> <td>25-49</td> <td>\$127.12</td> </tr> <tr> <td>50-99</td> <td>\$117.55</td> </tr> <tr> <td>100 +</td> <td>\$109.35</td> </tr> </tbody> </table> <p>PRECISION Model No: PE9324 3.5mm Male To N Female Max VSWR 1.15:1 @ 18 GHz</p>	PRICE		1-24	\$136.69	25-49	\$127.12	50-99	\$117.55	100 +	\$109.35	 <table border="1"> <thead> <tr> <th colspan="2">PRICE</th> </tr> </thead> <tbody> <tr> <td>1-24</td> <td>\$128.18</td> </tr> <tr> <td>25-49</td> <td>\$119.21</td> </tr> <tr> <td>50-99</td> <td>\$110.23</td> </tr> <tr> <td>100 +</td> <td>\$102.54</td> </tr> </tbody> </table> <p>PRECISION Model No: PE9321 3.5mm Female To N Male Max VSWR 1.15:1 @ 18 GHz</p>	PRICE		1-24	\$128.18	25-49	\$119.21	50-99	\$110.23	100 +	\$102.54
	PRICE																																											
1-24	\$141.25																																											
25-49	\$131.36																																											
50-99	\$121.48																																											
100 +	\$113.00																																											
PRICE																																												
1-24	\$144.60																																											
25-49	\$134.48																																											
50-99	\$124.36																																											
100 +	\$115.68																																											
PRICE																																												
1-24	\$136.69																																											
25-49	\$127.12																																											
50-99	\$117.55																																											
100 +	\$109.35																																											
PRICE																																												
1-24	\$128.18																																											
25-49	\$119.21																																											
50-99	\$110.23																																											
100 +	\$102.54																																											
4	 <table border="1"> <thead> <tr> <th colspan="2">PRICE</th> </tr> </thead> <tbody> <tr> <td>1-24</td> <td>\$129.80</td> </tr> <tr> <td>25-49</td> <td>\$120.71</td> </tr> <tr> <td>50-99</td> <td>\$111.63</td> </tr> <tr> <td>100 +</td> <td>\$103.84</td> </tr> </tbody> </table> <p>PRECISION Model No: PE9323 3.5mm Female To N Female Max VSWR 1.15:1 @ 18 GHz</p>	PRICE		1-24	\$129.80	25-49	\$120.71	50-99	\$111.63	100 +	\$103.84	 <table border="1"> <thead> <tr> <th colspan="2">PRICE</th> </tr> </thead> <tbody> <tr> <td>1-24</td> <td>\$231.49</td> </tr> <tr> <td>25-49</td> <td>\$215.29</td> </tr> <tr> <td>50-99</td> <td>\$199.08</td> </tr> <tr> <td>100 +</td> <td>\$185.19</td> </tr> </tbody> </table> <p>PRECISION Model No: PE9326 3.5mm Male To 7mm Max VSWR 1.15:1 @ 18 GHz</p>	PRICE		1-24	\$231.49	25-49	\$215.29	50-99	\$199.08	100 +	\$185.19	 <table border="1"> <thead> <tr> <th colspan="2">PRICE</th> </tr> </thead> <tbody> <tr> <td>1-24</td> <td>\$337.48</td> </tr> <tr> <td>25-49</td> <td>\$313.86</td> </tr> <tr> <td>50-99</td> <td>\$290.23</td> </tr> <tr> <td>100 +</td> <td>\$269.98</td> </tr> </tbody> </table> <p>PRECISION Model No: PE9325 3.5mm Female To 7mm Max VSWR 1.15:1 @ 18 GHz</p>	PRICE		1-24	\$337.48	25-49	\$313.86	50-99	\$290.23	100 +	\$269.98	<div style="background-color: black; color: white; padding: 20px; text-align: center;"> <p>2.92mm In-Series</p> <p>→</p> </div>										
	PRICE																																											
1-24	\$129.80																																											
25-49	\$120.71																																											
50-99	\$111.63																																											
100 +	\$103.84																																											
PRICE																																												
1-24	\$231.49																																											
25-49	\$215.29																																											
50-99	\$199.08																																											
100 +	\$185.19																																											
PRICE																																												
1-24	\$337.48																																											
25-49	\$313.86																																											
50-99	\$290.23																																											
100 +	\$269.98																																											
5	 <table border="1"> <thead> <tr> <th colspan="2">PRICE</th> </tr> </thead> <tbody> <tr> <td>1-24</td> <td>\$150.42</td> </tr> <tr> <td>25-49</td> <td>\$139.89</td> </tr> <tr> <td>50-99</td> <td>\$129.36</td> </tr> <tr> <td>100 +</td> <td>\$120.34</td> </tr> </tbody> </table> <p>PRECISION Model No: PE9436 2.92mm Male To 2.92mm Male Max VSWR 1.10:1 @ 18 GHz 1.15:1 @ 26.5 GHz 1.25:1 @ 40 GHz</p>	PRICE		1-24	\$150.42	25-49	\$139.89	50-99	\$129.36	100 +	\$120.34	 <table border="1"> <thead> <tr> <th colspan="2">PRICE</th> </tr> </thead> <tbody> <tr> <td>1-24</td> <td>\$231.49</td> </tr> <tr> <td>25-49</td> <td>\$215.29</td> </tr> <tr> <td>50-99</td> <td>\$199.08</td> </tr> <tr> <td>100 +</td> <td>\$185.19</td> </tr> </tbody> </table> <p>PRECISION Model No: PE9645 2.92mm Male To 2.92mm Male Right Angle Max VSWR 1.40:1 @ 40 GHz</p>	PRICE		1-24	\$231.49	25-49	\$215.29	50-99	\$199.08	100 +	\$185.19	 <table border="1"> <thead> <tr> <th colspan="2">PRICE</th> </tr> </thead> <tbody> <tr> <td>1-24</td> <td>\$150.42</td> </tr> <tr> <td>25-49</td> <td>\$139.89</td> </tr> <tr> <td>50-99</td> <td>\$129.36</td> </tr> <tr> <td>100 +</td> <td>\$120.34</td> </tr> </tbody> </table> <p>PRECISION Model No: PE9437 2.92mm Male To 2.92mm Female Max VSWR 1.10:1 @ 18 GHz 1.15:1 @ 26.5 GHz 1.25:1 @ 40 GHz</p>	PRICE		1-24	\$150.42	25-49	\$139.89	50-99	\$129.36	100 +	\$120.34	 <table border="1"> <thead> <tr> <th colspan="2">PRICE</th> </tr> </thead> <tbody> <tr> <td>1-24</td> <td>\$229.26</td> </tr> <tr> <td>25-49</td> <td>\$213.21</td> </tr> <tr> <td>50-99</td> <td>\$197.16</td> </tr> <tr> <td>100 +</td> <td>\$183.41</td> </tr> </tbody> </table> <p>PRECISION Model No: PE9644 2.92mm Male To 2.92mm Female Right Angle Max VSWR 1.40:1 @ 40 GHz</p>	PRICE		1-24	\$229.26	25-49	\$213.21	50-99	\$197.16	100 +	\$183.41
	PRICE																																											
1-24	\$150.42																																											
25-49	\$139.89																																											
50-99	\$129.36																																											
100 +	\$120.34																																											
PRICE																																												
1-24	\$231.49																																											
25-49	\$215.29																																											
50-99	\$199.08																																											
100 +	\$185.19																																											
PRICE																																												
1-24	\$150.42																																											
25-49	\$139.89																																											
50-99	\$129.36																																											
100 +	\$120.34																																											
PRICE																																												
1-24	\$229.26																																											
25-49	\$213.21																																											
50-99	\$197.16																																											
100 +	\$183.41																																											
6	 <table border="1"> <thead> <tr> <th colspan="2">PRICE</th> </tr> </thead> <tbody> <tr> <td>1-24</td> <td>\$151.54</td> </tr> <tr> <td>25-49</td> <td>\$140.93</td> </tr> <tr> <td>50-99</td> <td>\$130.32</td> </tr> <tr> <td>100 +</td> <td>\$121.23</td> </tr> </tbody> </table> <p>PRECISION Model No: PE9438 2.92mm Female To 2.92mm Female, Max VSWR 1.10:1 @ 18 GHz, 1.15:1 @ 26.5 GHz 1.25:1 @ 40 GHz</p>	PRICE		1-24	\$151.54	25-49	\$140.93	50-99	\$130.32	100 +	\$121.23	 <table border="1"> <thead> <tr> <th colspan="2">PRICE</th> </tr> </thead> <tbody> <tr> <td>1-24</td> <td>\$164.21</td> </tr> <tr> <td>25-49</td> <td>\$152.72</td> </tr> <tr> <td>50-99</td> <td>\$141.22</td> </tr> <tr> <td>100 +</td> <td>\$131.37</td> </tr> </tbody> </table> <p>PRECISION Model No: PE9647 2.92mm Female To 2.92mm Female Bulkhead Mounting Hole B02 Max VSWR 1.25:1 @ 40 GHz</p>	PRICE		1-24	\$164.21	25-49	\$152.72	50-99	\$141.22	100 +	\$131.37	 <table border="1"> <thead> <tr> <th colspan="2">PRICE</th> </tr> </thead> <tbody> <tr> <td>1-24</td> <td>\$162.08</td> </tr> <tr> <td>25-49</td> <td>\$150.73</td> </tr> <tr> <td>50-99</td> <td>\$139.39</td> </tr> <tr> <td>100 +</td> <td>\$129.66</td> </tr> </tbody> </table> <p>PRECISION Model No: PE9648 2.92mm Female To 2.92mm Female, 4 Hole Panel Mount Max VSWR 1.35:1 @ 40 GHz Mounting Hole A01</p>	PRICE		1-24	\$162.08	25-49	\$150.73	50-99	\$139.39	100 +	\$129.66	 <table border="1"> <thead> <tr> <th colspan="2">PRICE</th> </tr> </thead> <tbody> <tr> <td>1-24</td> <td>\$235.44</td> </tr> <tr> <td>25-49</td> <td>\$218.96</td> </tr> <tr> <td>50-99</td> <td>\$202.48</td> </tr> <tr> <td>100 +</td> <td>\$188.35</td> </tr> </tbody> </table> <p>PRECISION Model No: PE9646 2.92mm Female To 2.92mm Female, Right Angle Max VSWR 1.40:1 @ 40 GHz</p>	PRICE		1-24	\$235.44	25-49	\$218.96	50-99	\$202.48	100 +	\$188.35
	PRICE																																											
1-24	\$151.54																																											
25-49	\$140.93																																											
50-99	\$130.32																																											
100 +	\$121.23																																											
PRICE																																												
1-24	\$164.21																																											
25-49	\$152.72																																											
50-99	\$141.22																																											
100 +	\$131.37																																											
PRICE																																												
1-24	\$162.08																																											
25-49	\$150.73																																											
50-99	\$139.39																																											
100 +	\$129.66																																											
PRICE																																												
1-24	\$235.44																																											
25-49	\$218.96																																											
50-99	\$202.48																																											
100 +	\$188.35																																											

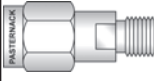
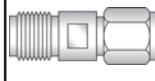
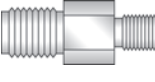
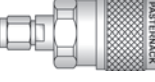
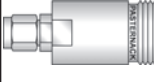
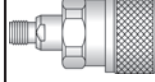
ROHS & REACH COMPLIANT. CUSTOM-LENGTH CABLE ASSEMBLIES MAY BE ORDERED ON OUR WEBSITE.

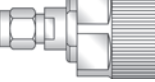
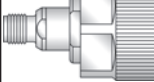
ADAPTERS

See Adapter Locator on Pages 140-145 or the Adapter Matrix on Pages 138-139

See Page 246 for Mounting Holes

	A	B	C	D																																								
1	 <p>2.92mm Between-Series</p> <p>→</p>	 <table border="1"> <thead> <tr> <th colspan="2">PRICE</th> </tr> </thead> <tbody> <tr> <td>1-24</td> <td>\$408.87</td> </tr> <tr> <td>25-49</td> <td>\$380.25</td> </tr> <tr> <td>50-99</td> <td>\$351.63</td> </tr> <tr> <td>100 +</td> <td>\$327.10</td> </tr> </tbody> </table> <p>PRECISION</p> <p>Model No: PE9457</p> <p>2.92mm Male To 2.4mm Male Max VSWR 1.10:1 @ 18 GHz 1.20:1 @ 26.5 GHz 1.30:1 @ 40 GHz</p>	PRICE		1-24	\$408.87	25-49	\$380.25	50-99	\$351.63	100 +	\$327.10	 <table border="1"> <thead> <tr> <th colspan="2">PRICE</th> </tr> </thead> <tbody> <tr> <td>1-24</td> <td>\$408.87</td> </tr> <tr> <td>25-49</td> <td>\$380.25</td> </tr> <tr> <td>50-99</td> <td>\$351.63</td> </tr> <tr> <td>100 +</td> <td>\$327.10</td> </tr> </tbody> </table> <p>PRECISION</p> <p>Model No: PE9455</p> <p>2.92mm Male To 2.4mm Female Max VSWR 1.10:1 @ 18 GHz 1.20:1 @ 26.5 GHz 1.30:1 @ 40 GHz</p>	PRICE		1-24	\$408.87	25-49	\$380.25	50-99	\$351.63	100 +	\$327.10	 <table border="1"> <thead> <tr> <th colspan="2">PRICE</th> </tr> </thead> <tbody> <tr> <td>1-24</td> <td>\$404.97</td> </tr> <tr> <td>25-49</td> <td>\$376.62</td> </tr> <tr> <td>50-99</td> <td>\$348.27</td> </tr> <tr> <td>100 +</td> <td>\$323.98</td> </tr> </tbody> </table> <p>PRECISION</p> <p>Model No: PE9454</p> <p>2.92mm Female To 2.4mm Male Max VSWR 1.10:1 @ 18 GHz 1.20:1 @ 26.5 GHz 1.30:1 @ 40 GHz</p>	PRICE		1-24	\$404.97	25-49	\$376.62	50-99	\$348.27	100 +	\$323.98										
		PRICE																																										
		1-24	\$408.87																																									
		25-49	\$380.25																																									
		50-99	\$351.63																																									
		100 +	\$327.10																																									
PRICE																																												
1-24	\$408.87																																											
25-49	\$380.25																																											
50-99	\$351.63																																											
100 +	\$327.10																																											
PRICE																																												
1-24	\$404.97																																											
25-49	\$376.62																																											
50-99	\$348.27																																											
100 +	\$323.98																																											
2	 <table border="1"> <thead> <tr> <th colspan="2">PRICE</th> </tr> </thead> <tbody> <tr> <td>1-24</td> <td>\$412.97</td> </tr> <tr> <td>25-49</td> <td>\$384.06</td> </tr> <tr> <td>50-99</td> <td>\$355.15</td> </tr> <tr> <td>100 +</td> <td>\$330.38</td> </tr> </tbody> </table> <p>PRECISION</p> <p>Model No: PE9456</p> <p>2.92mm Female To 2.4mm Female, Max VSWR 1.10:1 @ 18 GHz, 1.20:1 @ 26.5 GHz 1.30:1 @ 40 GHz</p>	PRICE		1-24	\$412.97	25-49	\$384.06	50-99	\$355.15	100 +	\$330.38	 <table border="1"> <thead> <tr> <th colspan="2">PRICE</th> </tr> </thead> <tbody> <tr> <td>1-24</td> <td>\$400.25</td> </tr> <tr> <td>25-49</td> <td>\$372.23</td> </tr> <tr> <td>50-99</td> <td>\$344.22</td> </tr> <tr> <td>100 +</td> <td>\$320.20</td> </tr> </tbody> </table> <p>PRECISION</p> <p>Model No: PE9667</p> <p>2.92mm Male To 1.85mm Male Max VSWR 1.25:1 @ 40 GHz</p>	PRICE		1-24	\$400.25	25-49	\$372.23	50-99	\$344.22	100 +	\$320.20	 <table border="1"> <thead> <tr> <th colspan="2">PRICE</th> </tr> </thead> <tbody> <tr> <td>1-24</td> <td>\$400.25</td> </tr> <tr> <td>25-49</td> <td>\$372.23</td> </tr> <tr> <td>50-99</td> <td>\$344.22</td> </tr> <tr> <td>100 +</td> <td>\$320.20</td> </tr> </tbody> </table> <p>PRECISION</p> <p>Model No: PE9666</p> <p>2.92mm Male To 1.85mm Female Max VSWR 1.25:1 @ 40 GHz</p>	PRICE		1-24	\$400.25	25-49	\$372.23	50-99	\$344.22	100 +	\$320.20	 <table border="1"> <thead> <tr> <th colspan="2">PRICE</th> </tr> </thead> <tbody> <tr> <td>1-24</td> <td>\$442.61</td> </tr> <tr> <td>25-49</td> <td>\$411.63</td> </tr> <tr> <td>50-99</td> <td>\$380.64</td> </tr> <tr> <td>100 +</td> <td>\$354.09</td> </tr> </tbody> </table> <p>PRECISION</p> <p>Model No: PE9665</p> <p>2.92mm Female To 1.85mm Male Max VSWR 1.30:1 @ 40 GHz</p>	PRICE		1-24	\$442.61	25-49	\$411.63	50-99	\$380.64	100 +	\$354.09
	PRICE																																											
	1-24	\$412.97																																										
	25-49	\$384.06																																										
	50-99	\$355.15																																										
	100 +	\$330.38																																										
PRICE																																												
1-24	\$400.25																																											
25-49	\$372.23																																											
50-99	\$344.22																																											
100 +	\$320.20																																											
PRICE																																												
1-24	\$400.25																																											
25-49	\$372.23																																											
50-99	\$344.22																																											
100 +	\$320.20																																											
PRICE																																												
1-24	\$442.61																																											
25-49	\$411.63																																											
50-99	\$380.64																																											
100 +	\$354.09																																											
3	 <table border="1"> <thead> <tr> <th colspan="2">PRICE</th> </tr> </thead> <tbody> <tr> <td>1-24</td> <td>\$393.62</td> </tr> <tr> <td>25-49</td> <td>\$366.07</td> </tr> <tr> <td>50-99</td> <td>\$338.51</td> </tr> <tr> <td>100 +</td> <td>\$314.90</td> </tr> </tbody> </table> <p>PRECISION</p> <p>Model No: PE9668</p> <p>2.92mm Female To 1.85mm Female Max VSWR 1.25:1 @ 40 GHz</p>	PRICE		1-24	\$393.62	25-49	\$366.07	50-99	\$338.51	100 +	\$314.90	 <table border="1"> <thead> <tr> <th colspan="2">PRICE</th> </tr> </thead> <tbody> <tr> <td>1-24</td> <td>\$229.51</td> </tr> <tr> <td>25-49</td> <td>\$213.44</td> </tr> <tr> <td>50-99</td> <td>\$197.38</td> </tr> <tr> <td>100 +</td> <td>\$183.61</td> </tr> </tbody> </table> <p>PRECISION</p> <p>Model No: PE9767</p> <p>2.92mm Male To SSMA Male Max VSWR 1.30:1 @ 40 GHz</p>	PRICE		1-24	\$229.51	25-49	\$213.44	50-99	\$197.38	100 +	\$183.61	 <table border="1"> <thead> <tr> <th colspan="2">PRICE</th> </tr> </thead> <tbody> <tr> <td>1-24</td> <td>\$164.81</td> </tr> <tr> <td>25-49</td> <td>\$153.27</td> </tr> <tr> <td>50-99</td> <td>\$141.74</td> </tr> <tr> <td>100 +</td> <td>\$131.85</td> </tr> </tbody> </table> <p>PRECISION</p> <p>Model No: PE9766</p> <p>2.92mm Male To SSMA Female Max VSWR 1.30:1 @ 40 GHz</p>	PRICE		1-24	\$164.81	25-49	\$153.27	50-99	\$141.74	100 +	\$131.85	 <table border="1"> <thead> <tr> <th colspan="2">PRICE</th> </tr> </thead> <tbody> <tr> <td>1-24</td> <td>\$164.81</td> </tr> <tr> <td>25-49</td> <td>\$153.27</td> </tr> <tr> <td>50-99</td> <td>\$141.74</td> </tr> <tr> <td>100 +</td> <td>\$131.85</td> </tr> </tbody> </table> <p>PRECISION</p> <p>Model No: PE9768</p> <p>2.92mm Female To SSMA Male Max VSWR 1.30:1 @ 40 GHz</p>	PRICE		1-24	\$164.81	25-49	\$153.27	50-99	\$141.74	100 +	\$131.85
	PRICE																																											
	1-24	\$393.62																																										
	25-49	\$366.07																																										
	50-99	\$338.51																																										
	100 +	\$314.90																																										
PRICE																																												
1-24	\$229.51																																											
25-49	\$213.44																																											
50-99	\$197.38																																											
100 +	\$183.61																																											
PRICE																																												
1-24	\$164.81																																											
25-49	\$153.27																																											
50-99	\$141.74																																											
100 +	\$131.85																																											
PRICE																																												
1-24	\$164.81																																											
25-49	\$153.27																																											
50-99	\$141.74																																											
100 +	\$131.85																																											
4	 <table border="1"> <thead> <tr> <th colspan="2">PRICE</th> </tr> </thead> <tbody> <tr> <td>1-24</td> <td>\$229.51</td> </tr> <tr> <td>25-49</td> <td>\$213.44</td> </tr> <tr> <td>50-99</td> <td>\$197.38</td> </tr> <tr> <td>100 +</td> <td>\$183.61</td> </tr> </tbody> </table> <p>PRECISION</p> <p>Model No: PE9769</p> <p>2.92mm Female To SSMA Female Max VSWR 1.30:1 @ 40 GHz</p>	PRICE		1-24	\$229.51	25-49	\$213.44	50-99	\$197.38	100 +	\$183.61	 <table border="1"> <thead> <tr> <th colspan="2">PRICE</th> </tr> </thead> <tbody> <tr> <td>1-24</td> <td>\$153.01</td> </tr> <tr> <td>25-49</td> <td>\$142.30</td> </tr> <tr> <td>50-99</td> <td>\$131.59</td> </tr> <tr> <td>100 +</td> <td>\$122.41</td> </tr> </tbody> </table> <p>PRECISION</p> <p>Model No: PE9661</p> <p>2.92mm Male To N Male Max VSWR 1.15:1 @ 18 GHz</p>	PRICE		1-24	\$153.01	25-49	\$142.30	50-99	\$131.59	100 +	\$122.41	 <table border="1"> <thead> <tr> <th colspan="2">PRICE</th> </tr> </thead> <tbody> <tr> <td>1-24</td> <td>\$247.19</td> </tr> <tr> <td>25-49</td> <td>\$229.89</td> </tr> <tr> <td>50-99</td> <td>\$212.58</td> </tr> <tr> <td>100 +</td> <td>\$197.75</td> </tr> </tbody> </table> <p>PRECISION</p> <p>Model No: PE9662</p> <p>2.92mm Male To N Female Max VSWR 1.15:1 @ 18 GHz</p>	PRICE		1-24	\$247.19	25-49	\$229.89	50-99	\$212.58	100 +	\$197.75	 <table border="1"> <thead> <tr> <th colspan="2">PRICE</th> </tr> </thead> <tbody> <tr> <td>1-24</td> <td>\$162.08</td> </tr> <tr> <td>25-49</td> <td>\$150.73</td> </tr> <tr> <td>50-99</td> <td>\$139.39</td> </tr> <tr> <td>100 +</td> <td>\$129.66</td> </tr> </tbody> </table> <p>PRECISION</p> <p>Model No: PE9663</p> <p>2.92mm Female To N Male Max VSWR 1.15:1 @ 18 GHz</p>	PRICE		1-24	\$162.08	25-49	\$150.73	50-99	\$139.39	100 +	\$129.66
	PRICE																																											
	1-24	\$229.51																																										
	25-49	\$213.44																																										
	50-99	\$197.38																																										
	100 +	\$183.61																																										
PRICE																																												
1-24	\$153.01																																											
25-49	\$142.30																																											
50-99	\$131.59																																											
100 +	\$122.41																																											
PRICE																																												
1-24	\$247.19																																											
25-49	\$229.89																																											
50-99	\$212.58																																											
100 +	\$197.75																																											
PRICE																																												
1-24	\$162.08																																											
25-49	\$150.73																																											
50-99	\$139.39																																											
100 +	\$129.66																																											
5	 <table border="1"> <thead> <tr> <th colspan="2">PRICE</th> </tr> </thead> <tbody> <tr> <td>1-24</td> <td>\$153.01</td> </tr> <tr> <td>25-49</td> <td>\$142.30</td> </tr> <tr> <td>50-99</td> <td>\$131.59</td> </tr> <tr> <td>100 +</td> <td>\$122.41</td> </tr> </tbody> </table> <p>PRECISION</p> <p>Model No: PE9664</p> <p>2.92mm Female To N Female Max VSWR 1.15:1 @ 18 GHz</p>	PRICE		1-24	\$153.01	25-49	\$142.30	50-99	\$131.59	100 +	\$122.41	 <table border="1"> <thead> <tr> <th colspan="2">PRICE</th> </tr> </thead> <tbody> <tr> <td>1-24</td> <td>\$353.24</td> </tr> <tr> <td>25-49</td> <td>\$328.51</td> </tr> <tr> <td>50-99</td> <td>\$303.79</td> </tr> <tr> <td>100 +</td> <td>\$282.59</td> </tr> </tbody> </table> <p>PRECISION</p> <p>Model No: PE9460</p> <p>2.92mm Male To 7mm Max VSWR 1.10:1 @ 18 GHz</p>	PRICE		1-24	\$353.24	25-49	\$328.51	50-99	\$303.79	100 +	\$282.59	 <table border="1"> <thead> <tr> <th colspan="2">PRICE</th> </tr> </thead> <tbody> <tr> <td>1-24</td> <td>\$353.24</td> </tr> <tr> <td>25-49</td> <td>\$328.51</td> </tr> <tr> <td>50-99</td> <td>\$303.79</td> </tr> <tr> <td>100 +</td> <td>\$282.59</td> </tr> </tbody> </table> <p>PRECISION</p> <p>Model No: PE9461</p> <p>2.92mm Female To 7mm Max VSWR 1.10:1 @ 18 GHz</p>	PRICE		1-24	\$353.24	25-49	\$328.51	50-99	\$303.79	100 +	\$282.59	 <table border="1"> <thead> <tr> <th colspan="2">PRICE</th> </tr> </thead> <tbody> <tr> <td>1-24</td> <td>\$529.80</td> </tr> <tr> <td>25-49</td> <td>\$492.71</td> </tr> <tr> <td>50-99</td> <td>\$455.63</td> </tr> <tr> <td>100 +</td> <td>\$423.84</td> </tr> </tbody> </table> <p>PRECISION</p> <p>Model No: PE9781</p> <p>2.92mm Female To Mini SMP Male Max VSWR 1.30:1 @ 40 GHz</p>	PRICE		1-24	\$529.80	25-49	\$492.71	50-99	\$455.63	100 +	\$423.84
	PRICE																																											
	1-24	\$153.01																																										
	25-49	\$142.30																																										
	50-99	\$131.59																																										
	100 +	\$122.41																																										
PRICE																																												
1-24	\$353.24																																											
25-49	\$328.51																																											
50-99	\$303.79																																											
100 +	\$282.59																																											
PRICE																																												
1-24	\$353.24																																											
25-49	\$328.51																																											
50-99	\$303.79																																											
100 +	\$282.59																																											
PRICE																																												
1-24	\$529.80																																											
25-49	\$492.71																																											
50-99	\$455.63																																											
100 +	\$423.84																																											
6	 <table border="1"> <thead> <tr> <th colspan="2">PRICE</th> </tr> </thead> <tbody> <tr> <td>1-24</td> <td>\$529.80</td> </tr> <tr> <td>25-49</td> <td>\$492.71</td> </tr> <tr> <td>50-99</td> <td>\$455.63</td> </tr> <tr> <td>100 +</td> <td>\$423.84</td> </tr> </tbody> </table> <p>PRECISION</p> <p>Model No: PE9782</p> <p>2.92mm Female To Mini SMP Female Max VSWR 1.30:1 @ 40 GHz</p>	PRICE		1-24	\$529.80	25-49	\$492.71	50-99	\$455.63	100 +	\$423.84	 <p>2.4mm In-Series</p> <p>→</p>	 <table border="1"> <thead> <tr> <th colspan="2">PRICE</th> </tr> </thead> <tbody> <tr> <td>1-24</td> <td>\$408.87</td> </tr> <tr> <td>25-49</td> <td>\$380.25</td> </tr> <tr> <td>50-99</td> <td>\$351.63</td> </tr> <tr> <td>100 +</td> <td>\$327.10</td> </tr> </tbody> </table> <p>PRECISION</p> <p>Model No: PE9451</p> <p>2.4mm Male To 2.4mm Male Max VSWR 1.10:1 @ 18 GHz 1.20:1 @ 26.5 GHz 1.30:1 @ 50 GHz</p>	PRICE		1-24	\$408.87	25-49	\$380.25	50-99	\$351.63	100 +	\$327.10	 <table border="1"> <thead> <tr> <th colspan="2">PRICE</th> </tr> </thead> <tbody> <tr> <td>1-24</td> <td>\$408.87</td> </tr> <tr> <td>25-49</td> <td>\$380.25</td> </tr> <tr> <td>50-99</td> <td>\$351.63</td> </tr> <tr> <td>100 +</td> <td>\$327.10</td> </tr> </tbody> </table> <p>PRECISION</p> <p>Model No: PE9452</p> <p>2.4mm Male To 2.4mm Female Max VSWR 1.10:1 @ 18 GHz 1.20:1 @ 26.5 GHz 1.30:1 @ 50 GHz</p>	PRICE		1-24	\$408.87	25-49	\$380.25	50-99	\$351.63	100 +	\$327.10										
	PRICE																																											
	1-24	\$529.80																																										
	25-49	\$492.71																																										
	50-99	\$455.63																																										
	100 +	\$423.84																																										
PRICE																																												
1-24	\$408.87																																											
25-49	\$380.25																																											
50-99	\$351.63																																											
100 +	\$327.10																																											
PRICE																																												
1-24	\$408.87																																											
25-49	\$380.25																																											
50-99	\$351.63																																											
100 +	\$327.10																																											



Free Freight Available
via UPS Ground
to USA & Canada



Real-Time Stock
Levels & Pricing
On Our Website



Toll-Free Technical
Support
(866) 727-8376











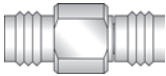
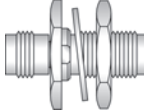

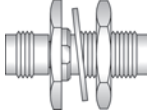
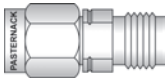
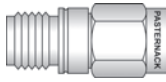

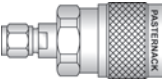
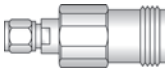
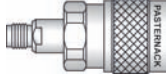

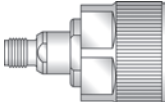

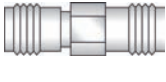

Same-Day Shipping,
Even Custom
Cable Assemblies

ADAPTERS

See Adapter Locator on Pages 140-145 or the Adapter Matrix on Pages 138-139

See Page 246 for Mounting Holes











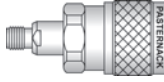
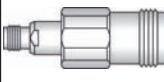

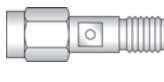
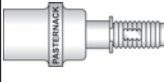
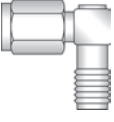
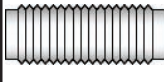

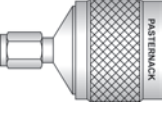
	A	B	C	D																																								
Adapters	 <table border="1"> <thead> <tr> <th colspan="2">PRICE</th> </tr> </thead> <tbody> <tr> <td>1-24</td> <td>\$428.93</td> </tr> <tr> <td>25-49</td> <td>\$398.90</td> </tr> <tr> <td>50-99</td> <td>\$368.88</td> </tr> <tr> <td>100 +</td> <td>\$343.14</td> </tr> </tbody> </table> <p>PRECISION Model No: PE9453 2.4mm Female To 2.4mm Female Max VSWR 1.10:1 @ 18 GHz 1.20:1 @ 26.5 GHz 1.30:1 @ 50 GHz</p>	PRICE		1-24	\$428.93	25-49	\$398.90	50-99	\$368.88	100 +	\$343.14	 <table border="1"> <thead> <tr> <th colspan="2">PRICE</th> </tr> </thead> <tbody> <tr> <td>1-24</td> <td>\$306.37</td> </tr> <tr> <td>25-49</td> <td>\$284.92</td> </tr> <tr> <td>50-99</td> <td>\$263.48</td> </tr> <tr> <td>100 +</td> <td>\$245.10</td> </tr> </tbody> </table> <p>PRECISION Model No: PE9640 2.4mm Female To 2.4mm Female Bulkhead, Mounting Hole B09 Max VSWR 1.40:1 @ 50 GHz</p>	PRICE		1-24	\$306.37	25-49	\$284.92	50-99	\$263.48	100 +	\$245.10	<div style="background-color: black; color: white; padding: 10px; text-align: center;"> <h2>2.4mm Between-Series</h2>  </div>	 <table border="1"> <thead> <tr> <th colspan="2">PRICE</th> </tr> </thead> <tbody> <tr> <td>1-24</td> <td>\$447.37</td> </tr> <tr> <td>25-49</td> <td>\$416.05</td> </tr> <tr> <td>50-99</td> <td>\$384.74</td> </tr> <tr> <td>100 +</td> <td>\$357.90</td> </tr> </tbody> </table> <p>PRECISION Model No: PE9672 2.4mm Male To 1.85mm Male Max VSWR 1.30:1 @ 50 GHz</p>	PRICE		1-24	\$447.37	25-49	\$416.05	50-99	\$384.74	100 +	\$357.90										
	PRICE																																											
	1-24	\$428.93																																										
	25-49	\$398.90																																										
	50-99	\$368.88																																										
	100 +	\$343.14																																										
PRICE																																												
1-24	\$306.37																																											
25-49	\$284.92																																											
50-99	\$263.48																																											
100 +	\$245.10																																											
PRICE																																												
1-24	\$447.37																																											
25-49	\$416.05																																											
50-99	\$384.74																																											
100 +	\$357.90																																											
2	 <table border="1"> <thead> <tr> <th colspan="2">PRICE</th> </tr> </thead> <tbody> <tr> <td>1-24</td> <td>\$435.62</td> </tr> <tr> <td>25-49</td> <td>\$405.13</td> </tr> <tr> <td>50-99</td> <td>\$374.63</td> </tr> <tr> <td>100 +</td> <td>\$348.50</td> </tr> </tbody> </table> <p>PRECISION Model No: PE9674 2.4mm Male To 1.85mm Female Max VSWR 1.30:1 @ 50 GHz</p>	PRICE		1-24	\$435.62	25-49	\$405.13	50-99	\$374.63	100 +	\$348.50	 <table border="1"> <thead> <tr> <th colspan="2">PRICE</th> </tr> </thead> <tbody> <tr> <td>1-24</td> <td>\$435.62</td> </tr> <tr> <td>25-49</td> <td>\$405.13</td> </tr> <tr> <td>50-99</td> <td>\$374.63</td> </tr> <tr> <td>100 +</td> <td>\$348.50</td> </tr> </tbody> </table> <p>PRECISION Model No: PE9673 2.4mm Female To 1.85mm Male Max VSWR 1.30:1 @ 50 GHz</p>	PRICE		1-24	\$435.62	25-49	\$405.13	50-99	\$374.63	100 +	\$348.50	 <table border="1"> <thead> <tr> <th colspan="2">PRICE</th> </tr> </thead> <tbody> <tr> <td>1-24</td> <td>\$435.62</td> </tr> <tr> <td>25-49</td> <td>\$405.13</td> </tr> <tr> <td>50-99</td> <td>\$374.63</td> </tr> <tr> <td>100 +</td> <td>\$348.50</td> </tr> </tbody> </table> <p>PRECISION Model No: PE9675 2.4mm Female To 1.85mm Female Max VSWR 1.30:1 @ 50 GHz</p>	PRICE		1-24	\$435.62	25-49	\$405.13	50-99	\$374.63	100 +	\$348.50	 <table border="1"> <thead> <tr> <th colspan="2">PRICE</th> </tr> </thead> <tbody> <tr> <td>1-24</td> <td>\$141.25</td> </tr> <tr> <td>25-49</td> <td>\$131.36</td> </tr> <tr> <td>50-99</td> <td>\$121.48</td> </tr> <tr> <td>100 +</td> <td>\$113.00</td> </tr> </tbody> </table> <p>PRECISION Model No: PE9504 2.4mm Male To N Male Max VSWR 1.15:1 @ 18 GHz</p>	PRICE		1-24	\$141.25	25-49	\$131.36	50-99	\$121.48	100 +	\$113.00
PRICE																																												
1-24	\$435.62																																											
25-49	\$405.13																																											
50-99	\$374.63																																											
100 +	\$348.50																																											
PRICE																																												
1-24	\$435.62																																											
25-49	\$405.13																																											
50-99	\$374.63																																											
100 +	\$348.50																																											
PRICE																																												
1-24	\$435.62																																											
25-49	\$405.13																																											
50-99	\$374.63																																											
100 +	\$348.50																																											
PRICE																																												
1-24	\$141.25																																											
25-49	\$131.36																																											
50-99	\$121.48																																											
100 +	\$113.00																																											
3	 <table border="1"> <thead> <tr> <th colspan="2">PRICE</th> </tr> </thead> <tbody> <tr> <td>1-24</td> <td>\$180.37</td> </tr> <tr> <td>25-49</td> <td>\$167.74</td> </tr> <tr> <td>50-99</td> <td>\$155.12</td> </tr> <tr> <td>100 +</td> <td>\$144.30</td> </tr> </tbody> </table> <p>PRECISION Model No: PE9501 2.4mm Male To N Female Max VSWR 1.15:1 @ 18 GHz</p>	PRICE		1-24	\$180.37	25-49	\$167.74	50-99	\$155.12	100 +	\$144.30	 <table border="1"> <thead> <tr> <th colspan="2">PRICE</th> </tr> </thead> <tbody> <tr> <td>1-24</td> <td>\$173.63</td> </tr> <tr> <td>25-49</td> <td>\$161.48</td> </tr> <tr> <td>50-99</td> <td>\$149.32</td> </tr> <tr> <td>100 +</td> <td>\$138.90</td> </tr> </tbody> </table> <p>PRECISION Model No: PE9503 2.4mm Female To N Male Max VSWR 1.15:1 @ 18 GHz</p>	PRICE		1-24	\$173.63	25-49	\$161.48	50-99	\$149.32	100 +	\$138.90	 <table border="1"> <thead> <tr> <th colspan="2">PRICE</th> </tr> </thead> <tbody> <tr> <td>1-24</td> <td>\$173.63</td> </tr> <tr> <td>25-49</td> <td>\$161.48</td> </tr> <tr> <td>50-99</td> <td>\$149.32</td> </tr> <tr> <td>100 +</td> <td>\$138.90</td> </tr> </tbody> </table> <p>PRECISION Model No: PE9502 2.4mm Female To N Female Max VSWR 1.15:1 @ 18 GHz</p>	PRICE		1-24	\$173.63	25-49	\$161.48	50-99	\$149.32	100 +	\$138.90	 <table border="1"> <thead> <tr> <th colspan="2">PRICE</th> </tr> </thead> <tbody> <tr> <td>1-24</td> <td>\$558.63</td> </tr> <tr> <td>25-49</td> <td>\$519.53</td> </tr> <tr> <td>50-99</td> <td>\$480.42</td> </tr> <tr> <td>100 +</td> <td>\$446.90</td> </tr> </tbody> </table> <p>PRECISION Model No: PE9458 2.4mm Male To 7mm Max VSWR 1.10:1 @ 18 GHz</p>	PRICE		1-24	\$558.63	25-49	\$519.53	50-99	\$480.42	100 +	\$446.90
PRICE																																												
1-24	\$180.37																																											
25-49	\$167.74																																											
50-99	\$155.12																																											
100 +	\$144.30																																											
PRICE																																												
1-24	\$173.63																																											
25-49	\$161.48																																											
50-99	\$149.32																																											
100 +	\$138.90																																											
PRICE																																												
1-24	\$173.63																																											
25-49	\$161.48																																											
50-99	\$149.32																																											
100 +	\$138.90																																											
PRICE																																												
1-24	\$558.63																																											
25-49	\$519.53																																											
50-99	\$480.42																																											
100 +	\$446.90																																											
4	 <table border="1"> <thead> <tr> <th colspan="2">PRICE</th> </tr> </thead> <tbody> <tr> <td>1-24</td> <td>\$588.68</td> </tr> <tr> <td>25-49</td> <td>\$547.47</td> </tr> <tr> <td>50-99</td> <td>\$506.26</td> </tr> <tr> <td>100 +</td> <td>\$470.94</td> </tr> </tbody> </table> <p>PRECISION Model No: PE9459 2.4mm Female To 7mm Max VSWR 1.10:1 @ 18 GHz</p>	PRICE		1-24	\$588.68	25-49	\$547.47	50-99	\$506.26	100 +	\$470.94	<div style="background-color: black; color: white; padding: 10px; text-align: center;"> <h2>1.85mm In-Series</h2>  </div>	 <table border="1"> <thead> <tr> <th colspan="2">PRICE</th> </tr> </thead> <tbody> <tr> <td>1-24</td> <td>\$459.13</td> </tr> <tr> <td>25-49</td> <td>\$426.99</td> </tr> <tr> <td>50-99</td> <td>\$394.85</td> </tr> <tr> <td>100 +</td> <td>\$367.30</td> </tr> </tbody> </table> <p>PRECISION Model No: PE9716 1.85mm Male To 1.85mm Male Max VSWR 1.50:1 @ 65 GHz</p>	PRICE		1-24	\$459.13	25-49	\$426.99	50-99	\$394.85	100 +	\$367.30	 <table border="1"> <thead> <tr> <th colspan="2">PRICE</th> </tr> </thead> <tbody> <tr> <td>1-24</td> <td>\$459.13</td> </tr> <tr> <td>25-49</td> <td>\$426.99</td> </tr> <tr> <td>50-99</td> <td>\$394.85</td> </tr> <tr> <td>100 +</td> <td>\$367.30</td> </tr> </tbody> </table> <p>PRECISION Model No: PE9715 1.85mm Male To 1.85mm Female Max VSWR 1.50:1 @ 65 GHz</p>	PRICE		1-24	\$459.13	25-49	\$426.99	50-99	\$394.85	100 +	\$367.30										
PRICE																																												
1-24	\$588.68																																											
25-49	\$547.47																																											
50-99	\$506.26																																											
100 +	\$470.94																																											
PRICE																																												
1-24	\$459.13																																											
25-49	\$426.99																																											
50-99	\$394.85																																											
100 +	\$367.30																																											
PRICE																																												
1-24	\$459.13																																											
25-49	\$426.99																																											
50-99	\$394.85																																											
100 +	\$367.30																																											
5	 <table border="1"> <thead> <tr> <th colspan="2">PRICE</th> </tr> </thead> <tbody> <tr> <td>1-24</td> <td>\$469.01</td> </tr> <tr> <td>25-49</td> <td>\$436.18</td> </tr> <tr> <td>50-99</td> <td>\$403.35</td> </tr> <tr> <td>100 +</td> <td>\$375.21</td> </tr> </tbody> </table> <p>PRECISION Model No: PE9717 1.85mm Female To 1.85mm Female Max VSWR 1.50:1 @ 65 GHz</p>	PRICE		1-24	\$469.01	25-49	\$436.18	50-99	\$403.35	100 +	\$375.21	<div style="background-color: black; color: white; padding: 10px; text-align: center;"> <h2>1.85mm Between-Series</h2>  </div>	 <table border="1"> <thead> <tr> <th colspan="2">PRICE</th> </tr> </thead> <tbody> <tr> <td>1-24</td> <td>\$229.51</td> </tr> <tr> <td>25-49</td> <td>\$213.44</td> </tr> <tr> <td>50-99</td> <td>\$197.38</td> </tr> <tr> <td>100 +</td> <td>\$183.61</td> </tr> </tbody> </table> <p>PRECISION Model No: PE9763 1.85mm Male To SSMA Male Max VSWR 1.30:1 @ 40 GHz</p>	PRICE		1-24	\$229.51	25-49	\$213.44	50-99	\$197.38	100 +	\$183.61	 <table border="1"> <thead> <tr> <th colspan="2">PRICE</th> </tr> </thead> <tbody> <tr> <td>1-24</td> <td>\$229.51</td> </tr> <tr> <td>25-49</td> <td>\$213.44</td> </tr> <tr> <td>50-99</td> <td>\$197.38</td> </tr> <tr> <td>100 +</td> <td>\$183.61</td> </tr> </tbody> </table> <p>PRECISION Model No: PE9762 1.85mm Male To SSMA Female Max VSWR 1.30:1 @ 40 GHz</p>	PRICE		1-24	\$229.51	25-49	\$213.44	50-99	\$197.38	100 +	\$183.61										
PRICE																																												
1-24	\$469.01																																											
25-49	\$436.18																																											
50-99	\$403.35																																											
100 +	\$375.21																																											
PRICE																																												
1-24	\$229.51																																											
25-49	\$213.44																																											
50-99	\$197.38																																											
100 +	\$183.61																																											
PRICE																																												
1-24	\$229.51																																											
25-49	\$213.44																																											
50-99	\$197.38																																											
100 +	\$183.61																																											
6	 <table border="1"> <thead> <tr> <th colspan="2">PRICE</th> </tr> </thead> <tbody> <tr> <td>1-24</td> <td>\$229.51</td> </tr> <tr> <td>25-49</td> <td>\$213.44</td> </tr> <tr> <td>50-99</td> <td>\$197.38</td> </tr> <tr> <td>100 +</td> <td>\$183.61</td> </tr> </tbody> </table> <p>PRECISION Model No: PE9764 1.85mm Female To SSMA Male Max VSWR 1.30:1 @ 40 GHz</p>	PRICE		1-24	\$229.51	25-49	\$213.44	50-99	\$197.38	100 +	\$183.61	 <table border="1"> <thead> <tr> <th colspan="2">PRICE</th> </tr> </thead> <tbody> <tr> <td>1-24</td> <td>\$229.51</td> </tr> <tr> <td>25-49</td> <td>\$213.44</td> </tr> <tr> <td>50-99</td> <td>\$197.38</td> </tr> <tr> <td>100 +</td> <td>\$183.61</td> </tr> </tbody> </table> <p>PRECISION Model No: PE9765 1.85mm Female To SSMA Female Max VSWR 1.30:1 @ 40 GHz</p>	PRICE		1-24	\$229.51	25-49	\$213.44	50-99	\$197.38	100 +	\$183.61	 <table border="1"> <thead> <tr> <th colspan="2">PRICE</th> </tr> </thead> <tbody> <tr> <td>1-24</td> <td>\$153.01</td> </tr> <tr> <td>25-49</td> <td>\$142.30</td> </tr> <tr> <td>50-99</td> <td>\$131.59</td> </tr> <tr> <td>100 +</td> <td>\$122.41</td> </tr> </tbody> </table> <p>PRECISION Model No: PE9718 1.85mm Male To N Male Max VSWR 1.25:1 @ 18 GHz</p>	PRICE		1-24	\$153.01	25-49	\$142.30	50-99	\$131.59	100 +	\$122.41	 <table border="1"> <thead> <tr> <th colspan="2">PRICE</th> </tr> </thead> <tbody> <tr> <td>1-24</td> <td>\$153.01</td> </tr> <tr> <td>25-49</td> <td>\$142.30</td> </tr> <tr> <td>50-99</td> <td>\$131.59</td> </tr> <tr> <td>100 +</td> <td>\$122.41</td> </tr> </tbody> </table> <p>PRECISION Model No: PE9719 1.85mm Male To N Female Max VSWR 1.25:1 @ 18 GHz</p>	PRICE		1-24	\$153.01	25-49	\$142.30	50-99	\$131.59	100 +	\$122.41
PRICE																																												
1-24	\$229.51																																											
25-49	\$213.44																																											
50-99	\$197.38																																											
100 +	\$183.61																																											
PRICE																																												
1-24	\$229.51																																											
25-49	\$213.44																																											
50-99	\$197.38																																											
100 +	\$183.61																																											
PRICE																																												
1-24	\$153.01																																											
25-49	\$142.30																																											
50-99	\$131.59																																											
100 +	\$122.41																																											
PRICE																																												
1-24	\$153.01																																											
25-49	\$142.30																																											
50-99	\$131.59																																											
100 +	\$122.41																																											

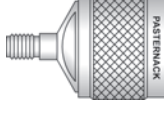
See Our Website For Real-Time Stock Availability!

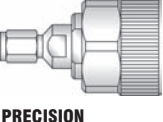
ADAPTERS

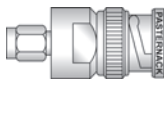
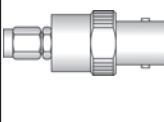
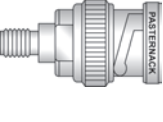
See Adapter Locator on Pages 140-145 or the Adapter Matrix on Pages 138-139

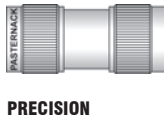
See Page 246 for Mounting Holes

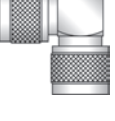
	A	B	C	D																																								
1	 <table border="1"> <thead> <tr> <th colspan="2">PRICE</th> </tr> </thead> <tbody> <tr> <td>1-24</td> <td>\$153.01</td> </tr> <tr> <td>25-49</td> <td>\$142.30</td> </tr> <tr> <td>50-99</td> <td>\$131.59</td> </tr> <tr> <td>100 +</td> <td>\$122.41</td> </tr> </tbody> </table> <p>PRECISION Model No: PE9720 1.85mm Female To N Male Max VSWR 1.25:1 @ 18 GHz</p>	PRICE		1-24	\$153.01	25-49	\$142.30	50-99	\$131.59	100 +	\$122.41	 <table border="1"> <thead> <tr> <th colspan="2">PRICE</th> </tr> </thead> <tbody> <tr> <td>1-24</td> <td>\$153.01</td> </tr> <tr> <td>25-49</td> <td>\$142.30</td> </tr> <tr> <td>50-99</td> <td>\$131.59</td> </tr> <tr> <td>100 +</td> <td>\$122.41</td> </tr> </tbody> </table> <p>PRECISION Model No: PE9721 1.85mm Female To N Female Max VSWR 1.25:1 @ 18 GHz</p>	PRICE		1-24	\$153.01	25-49	\$142.30	50-99	\$131.59	100 +	\$122.41	<p>SSMA <i>In-Series</i></p> 		 <table border="1"> <thead> <tr> <th colspan="2">PRICE</th> </tr> </thead> <tbody> <tr> <td>1-24</td> <td>\$83.50</td> </tr> <tr> <td>25-49</td> <td>\$77.66</td> </tr> <tr> <td>50-99</td> <td>\$71.81</td> </tr> <tr> <td>100 +</td> <td>\$66.80</td> </tr> </tbody> </table> <p>Model No: PE9357 SSMA Male To SSMA Male</p>	PRICE		1-24	\$83.50	25-49	\$77.66	50-99	\$71.81	100 +	\$66.80									
	PRICE																																											
1-24	\$153.01																																											
25-49	\$142.30																																											
50-99	\$131.59																																											
100 +	\$122.41																																											
PRICE																																												
1-24	\$153.01																																											
25-49	\$142.30																																											
50-99	\$131.59																																											
100 +	\$122.41																																											
PRICE																																												
1-24	\$83.50																																											
25-49	\$77.66																																											
50-99	\$71.81																																											
100 +	\$66.80																																											
2	 <table border="1"> <thead> <tr> <th colspan="2">PRICE</th> </tr> </thead> <tbody> <tr> <td>1-24</td> <td>\$47.12</td> </tr> <tr> <td>25-49</td> <td>\$43.82</td> </tr> <tr> <td>50-99</td> <td>\$40.52</td> </tr> <tr> <td>100 +</td> <td>\$37.70</td> </tr> </tbody> </table> <p>Model No: PE9358 SSMA Male To SSMA Female</p>	PRICE		1-24	\$47.12	25-49	\$43.82	50-99	\$40.52	100 +	\$37.70	 <table border="1"> <thead> <tr> <th colspan="2">PRICE</th> </tr> </thead> <tbody> <tr> <td>1-24</td> <td>\$116.78</td> </tr> <tr> <td>25-49</td> <td>\$108.61</td> </tr> <tr> <td>50-99</td> <td>\$100.43</td> </tr> <tr> <td>100 +</td> <td>\$93.42</td> </tr> </tbody> </table> <p>Model No: PE9685 SSMA Male Quick Disconnect To SSMA Female</p>	PRICE		1-24	\$116.78	25-49	\$108.61	50-99	\$100.43	100 +	\$93.42	 <table border="1"> <thead> <tr> <th colspan="2">PRICE</th> </tr> </thead> <tbody> <tr> <td>1-24</td> <td>\$60.54</td> </tr> <tr> <td>25-49</td> <td>\$56.30</td> </tr> <tr> <td>50-99</td> <td>\$52.06</td> </tr> <tr> <td>100 +</td> <td>\$48.43</td> </tr> </tbody> </table> <p>Model No: PE9334 SSMA Male To SSMA Female Right Angle</p>	PRICE		1-24	\$60.54	25-49	\$56.30	50-99	\$52.06	100 +	\$48.43	 <table border="1"> <thead> <tr> <th colspan="2">PRICE</th> </tr> </thead> <tbody> <tr> <td>1-24</td> <td>\$47.12</td> </tr> <tr> <td>25-49</td> <td>\$43.82</td> </tr> <tr> <td>50-99</td> <td>\$40.52</td> </tr> <tr> <td>100 +</td> <td>\$37.70</td> </tr> </tbody> </table> <p>Model No: PE9192 SSMA Female To SSMA Female</p>	PRICE		1-24	\$47.12	25-49	\$43.82	50-99	\$40.52	100 +	\$37.70
	PRICE																																											
1-24	\$47.12																																											
25-49	\$43.82																																											
50-99	\$40.52																																											
100 +	\$37.70																																											
PRICE																																												
1-24	\$116.78																																											
25-49	\$108.61																																											
50-99	\$100.43																																											
100 +	\$93.42																																											
PRICE																																												
1-24	\$60.54																																											
25-49	\$56.30																																											
50-99	\$52.06																																											
100 +	\$48.43																																											
PRICE																																												
1-24	\$47.12																																											
25-49	\$43.82																																											
50-99	\$40.52																																											
100 +	\$37.70																																											
3	 <table border="1"> <thead> <tr> <th colspan="2">PRICE</th> </tr> </thead> <tbody> <tr> <td>1-24</td> <td>\$46.21</td> </tr> <tr> <td>25-49</td> <td>\$42.98</td> </tr> <tr> <td>50-99</td> <td>\$39.74</td> </tr> <tr> <td>100 +</td> <td>\$36.97</td> </tr> </tbody> </table> <p>Model No: PE9189 SSMA Female To SSMA Female Bulkhead Mounting Hole B01</p>	PRICE		1-24	\$46.21	25-49	\$42.98	50-99	\$39.74	100 +	\$36.97	<p>SSMA <i>Between-Series</i></p> 		 <table border="1"> <thead> <tr> <th colspan="2">PRICE</th> </tr> </thead> <tbody> <tr> <td>1-24</td> <td>\$57.76</td> </tr> <tr> <td>25-49</td> <td>\$53.72</td> </tr> <tr> <td>50-99</td> <td>\$49.67</td> </tr> <tr> <td>100 +</td> <td>\$46.21</td> </tr> </tbody> </table> <p>Model No: PE9351 SSMA Male To N Male</p>	PRICE		1-24	\$57.76	25-49	\$53.72	50-99	\$49.67	100 +	\$46.21	 <table border="1"> <thead> <tr> <th colspan="2">PRICE</th> </tr> </thead> <tbody> <tr> <td>1-24</td> <td>\$67.44</td> </tr> <tr> <td>25-49</td> <td>\$62.72</td> </tr> <tr> <td>50-99</td> <td>\$58.00</td> </tr> <tr> <td>100 +</td> <td>\$53.95</td> </tr> </tbody> </table> <p>Model No: PE9353 SSMA Male To N Female</p>	PRICE		1-24	\$67.44	25-49	\$62.72	50-99	\$58.00	100 +	\$53.95									
	PRICE																																											
1-24	\$46.21																																											
25-49	\$42.98																																											
50-99	\$39.74																																											
100 +	\$36.97																																											
PRICE																																												
1-24	\$57.76																																											
25-49	\$53.72																																											
50-99	\$49.67																																											
100 +	\$46.21																																											
PRICE																																												
1-24	\$67.44																																											
25-49	\$62.72																																											
50-99	\$58.00																																											
100 +	\$53.95																																											
4	 <table border="1"> <thead> <tr> <th colspan="2">PRICE</th> </tr> </thead> <tbody> <tr> <td>1-24</td> <td>\$57.76</td> </tr> <tr> <td>25-49</td> <td>\$53.72</td> </tr> <tr> <td>50-99</td> <td>\$49.67</td> </tr> <tr> <td>100 +</td> <td>\$46.21</td> </tr> </tbody> </table> <p>Model No: PE9352 SSMA Female To N Male</p>	PRICE		1-24	\$57.76	25-49	\$53.72	50-99	\$49.67	100 +	\$46.21	 <table border="1"> <thead> <tr> <th colspan="2">PRICE</th> </tr> </thead> <tbody> <tr> <td>1-24</td> <td>\$58.87</td> </tr> <tr> <td>25-49</td> <td>\$54.75</td> </tr> <tr> <td>50-99</td> <td>\$50.63</td> </tr> <tr> <td>100 +</td> <td>\$47.10</td> </tr> </tbody> </table> <p>Model No: PE9354 SSMA Female To N Female</p>	PRICE		1-24	\$58.87	25-49	\$54.75	50-99	\$50.63	100 +	\$47.10	 <table border="1"> <thead> <tr> <th colspan="2">PRICE</th> </tr> </thead> <tbody> <tr> <td>1-24</td> <td>\$247.25</td> </tr> <tr> <td>25-49</td> <td>\$229.94</td> </tr> <tr> <td>50-99</td> <td>\$212.64</td> </tr> <tr> <td>100 +</td> <td>\$197.80</td> </tr> </tbody> </table> <p>PRECISION Model No: PE9355 SSMA Male To 7mm Max VSWR 1.15:1 @ 18 GHz</p>	PRICE		1-24	\$247.25	25-49	\$229.94	50-99	\$212.64	100 +	\$197.80	 <table border="1"> <thead> <tr> <th colspan="2">PRICE</th> </tr> </thead> <tbody> <tr> <td>1-24</td> <td>\$247.25</td> </tr> <tr> <td>25-49</td> <td>\$229.94</td> </tr> <tr> <td>50-99</td> <td>\$212.64</td> </tr> <tr> <td>100 +</td> <td>\$197.80</td> </tr> </tbody> </table> <p>PRECISION Model No: PE9356 SSMA Female To 7mm Max VSWR 1.15:1 @ 18 GHz</p>	PRICE		1-24	\$247.25	25-49	\$229.94	50-99	\$212.64	100 +	\$197.80
	PRICE																																											
1-24	\$57.76																																											
25-49	\$53.72																																											
50-99	\$49.67																																											
100 +	\$46.21																																											
PRICE																																												
1-24	\$58.87																																											
25-49	\$54.75																																											
50-99	\$50.63																																											
100 +	\$47.10																																											
PRICE																																												
1-24	\$247.25																																											
25-49	\$229.94																																											
50-99	\$212.64																																											
100 +	\$197.80																																											
PRICE																																												
1-24	\$247.25																																											
25-49	\$229.94																																											
50-99	\$212.64																																											
100 +	\$197.80																																											
5	 <table border="1"> <thead> <tr> <th colspan="2">PRICE</th> </tr> </thead> <tbody> <tr> <td>1-24</td> <td>\$84.86</td> </tr> <tr> <td>25-49</td> <td>\$78.92</td> </tr> <tr> <td>50-99</td> <td>\$72.98</td> </tr> <tr> <td>100 +</td> <td>\$67.89</td> </tr> </tbody> </table> <p>Model No: PE9213 SSMA Male To BNC Male</p>	PRICE		1-24	\$84.86	25-49	\$78.92	50-99	\$72.98	100 +	\$67.89	 <table border="1"> <thead> <tr> <th colspan="2">PRICE</th> </tr> </thead> <tbody> <tr> <td>1-24</td> <td>\$94.08</td> </tr> <tr> <td>25-49</td> <td>\$87.49</td> </tr> <tr> <td>50-99</td> <td>\$80.91</td> </tr> <tr> <td>100 +</td> <td>\$75.26</td> </tr> </tbody> </table> <p>Model No: PE9250 SSMA Male To BNC Female</p>	PRICE		1-24	\$94.08	25-49	\$87.49	50-99	\$80.91	100 +	\$75.26	 <table border="1"> <thead> <tr> <th colspan="2">PRICE</th> </tr> </thead> <tbody> <tr> <td>1-24</td> <td>\$56.24</td> </tr> <tr> <td>25-49</td> <td>\$52.30</td> </tr> <tr> <td>50-99</td> <td>\$48.37</td> </tr> <tr> <td>100 +</td> <td>\$44.99</td> </tr> </tbody> </table> <p>Model No: PE9191 SSMA Female To BNC Male</p>	PRICE		1-24	\$56.24	25-49	\$52.30	50-99	\$48.37	100 +	\$44.99	<p>N <i>In-Series</i></p> 										
	PRICE																																											
1-24	\$84.86																																											
25-49	\$78.92																																											
50-99	\$72.98																																											
100 +	\$67.89																																											
PRICE																																												
1-24	\$94.08																																											
25-49	\$87.49																																											
50-99	\$80.91																																											
100 +	\$75.26																																											
PRICE																																												
1-24	\$56.24																																											
25-49	\$52.30																																											
50-99	\$48.37																																											
100 +	\$44.99																																											
6	 <table border="1"> <thead> <tr> <th colspan="2">PRICE</th> </tr> </thead> <tbody> <tr> <td>1-24</td> <td>\$70.88</td> </tr> <tr> <td>25-49</td> <td>\$65.92</td> </tr> <tr> <td>50-99</td> <td>\$60.96</td> </tr> <tr> <td>100 +</td> <td>\$56.70</td> </tr> </tbody> </table> <p>PRECISION Model No: PE9427 N Male To N Male Max VSWR 1.15:1 @ 18 GHz</p>	PRICE		1-24	\$70.88	25-49	\$65.92	50-99	\$60.96	100 +	\$56.70	 <table border="1"> <thead> <tr> <th colspan="2">PRICE</th> </tr> </thead> <tbody> <tr> <td>1-24</td> <td>\$70.00</td> </tr> <tr> <td>25-49</td> <td>\$65.10</td> </tr> <tr> <td>50-99</td> <td>\$60.20</td> </tr> <tr> <td>100 +</td> <td>\$56.00</td> </tr> </tbody> </table> <p>PRECISION NEW Model No: PE91034 N Male To N Male Low PIM, Low VSWR</p>	PRICE		1-24	\$70.00	25-49	\$65.10	50-99	\$60.20	100 +	\$56.00	 <table border="1"> <thead> <tr> <th colspan="2">PRICE</th> </tr> </thead> <tbody> <tr> <td>1-24</td> <td>\$11.70</td> </tr> <tr> <td>25-49</td> <td>\$10.88</td> </tr> <tr> <td>50-99</td> <td>\$10.06</td> </tr> <tr> <td>100 +</td> <td>\$9.36</td> </tr> </tbody> </table> <p>Model No: PE9007 N Male To N Male</p>	PRICE		1-24	\$11.70	25-49	\$10.88	50-99	\$10.06	100 +	\$9.36	 <table border="1"> <thead> <tr> <th colspan="2">PRICE</th> </tr> </thead> <tbody> <tr> <td>1-24</td> <td>\$26.19</td> </tr> <tr> <td>25-49</td> <td>\$24.36</td> </tr> <tr> <td>50-99</td> <td>\$22.52</td> </tr> <tr> <td>100 +</td> <td>\$20.95</td> </tr> </tbody> </table> <p>Model No: PE9198 N Male To N Male Right Angle</p>	PRICE		1-24	\$26.19	25-49	\$24.36	50-99	\$22.52	100 +	\$20.95
	PRICE																																											
1-24	\$70.88																																											
25-49	\$65.92																																											
50-99	\$60.96																																											
100 +	\$56.70																																											
PRICE																																												
1-24	\$70.00																																											
25-49	\$65.10																																											
50-99	\$60.20																																											
100 +	\$56.00																																											
PRICE																																												
1-24	\$11.70																																											
25-49	\$10.88																																											
50-99	\$10.06																																											
100 +	\$9.36																																											
PRICE																																												
1-24	\$26.19																																											
25-49	\$24.36																																											
50-99	\$22.52																																											
100 +	\$20.95																																											

Adapters

See Our Website For Real-Time Stock Availability!











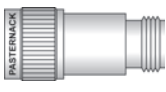
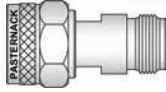
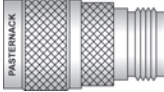

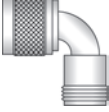

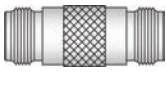

ADAPTERS

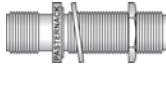
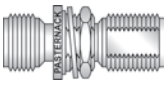
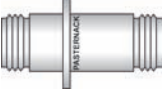
See Adapter Locator on Pages 140-145 or the Adapter Matrix on Pages 138-139

See Page 246 for Mounting Holes

Adapters

See Our Website For Real-Time Stock Availability!

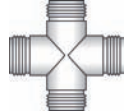









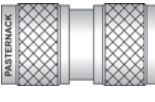
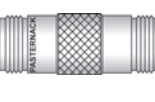
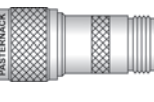
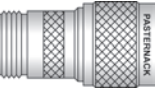

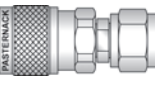
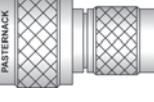
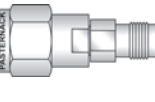
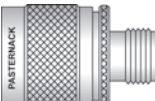
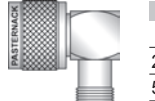
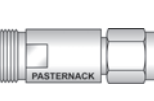
	A	B	C	D																																								
1	 <table border="1"> <thead> <tr> <th colspan="2">PRICE</th> </tr> </thead> <tbody> <tr> <td>1-24</td> <td>\$99.81</td> </tr> <tr> <td>25-49</td> <td>\$92.82</td> </tr> <tr> <td>50-99</td> <td>\$85.84</td> </tr> <tr> <td>100 +</td> <td>\$79.85</td> </tr> </tbody> </table> <p>PRECISION</p> <p>Model No: PE9426</p> <p>N Male To N Female Max VSWR 1.15:1 @ 18 GHz</p>	PRICE		1-24	\$99.81	25-49	\$92.82	50-99	\$85.84	100 +	\$79.85	 <table border="1"> <thead> <tr> <th colspan="2">PRICE</th> </tr> </thead> <tbody> <tr> <td>1-24</td> <td>\$65.00</td> </tr> <tr> <td>25-49</td> <td>\$60.45</td> </tr> <tr> <td>50-99</td> <td>\$55.90</td> </tr> <tr> <td>100 +</td> <td>\$52.00</td> </tr> </tbody> </table> <p>PRECISION NEW</p> <p>Model No: PE91040</p> <p>N Male To N Female Low PIM, Low VSWR</p>	PRICE		1-24	\$65.00	25-49	\$60.45	50-99	\$55.90	100 +	\$52.00	 <table border="1"> <thead> <tr> <th colspan="2">PRICE</th> </tr> </thead> <tbody> <tr> <td>1-24</td> <td>\$20.67</td> </tr> <tr> <td>25-49</td> <td>\$19.22</td> </tr> <tr> <td>50-99</td> <td>\$17.78</td> </tr> <tr> <td>100 +</td> <td>\$16.54</td> </tr> </tbody> </table> <p>Model No: PE9311</p> <p>N Male To N Female</p>	PRICE		1-24	\$20.67	25-49	\$19.22	50-99	\$17.78	100 +	\$16.54	 <table border="1"> <thead> <tr> <th colspan="2">PRICE</th> </tr> </thead> <tbody> <tr> <td>1-24</td> <td>\$127.32</td> </tr> <tr> <td>25-49</td> <td>\$118.41</td> </tr> <tr> <td>50-99</td> <td>\$109.50</td> </tr> <tr> <td>100 +</td> <td>\$101.86</td> </tr> </tbody> </table> <p>Model No: PE9547</p> <p>N Male Quick Disconnect To N Female</p>	PRICE		1-24	\$127.32	25-49	\$118.41	50-99	\$109.50	100 +	\$101.86
	PRICE																																											
1-24	\$99.81																																											
25-49	\$92.82																																											
50-99	\$85.84																																											
100 +	\$79.85																																											
PRICE																																												
1-24	\$65.00																																											
25-49	\$60.45																																											
50-99	\$55.90																																											
100 +	\$52.00																																											
PRICE																																												
1-24	\$20.67																																											
25-49	\$19.22																																											
50-99	\$17.78																																											
100 +	\$16.54																																											
PRICE																																												
1-24	\$127.32																																											
25-49	\$118.41																																											
50-99	\$109.50																																											
100 +	\$101.86																																											
2	 <table border="1"> <thead> <tr> <th colspan="2">PRICE</th> </tr> </thead> <tbody> <tr> <td>1-24</td> <td>\$33.08</td> </tr> <tr> <td>25-49</td> <td>\$30.76</td> </tr> <tr> <td>50-99</td> <td>\$28.45</td> </tr> <tr> <td>100 +</td> <td>\$26.46</td> </tr> </tbody> </table> <p>Model No: PE9595</p> <p>N Male To N Female Bulkhead Mounting Hole G01</p>	PRICE		1-24	\$33.08	25-49	\$30.76	50-99	\$28.45	100 +	\$26.46	 <table border="1"> <thead> <tr> <th colspan="2">PRICE</th> </tr> </thead> <tbody> <tr> <td>1-24</td> <td>\$177.18</td> </tr> <tr> <td>25-49</td> <td>\$164.78</td> </tr> <tr> <td>50-99</td> <td>\$152.37</td> </tr> <tr> <td>100 +</td> <td>\$141.74</td> </tr> </tbody> </table> <p>PRECISION</p> <p>Model No: PE9515</p> <p>N Male To N Female Radius Right Angle Max VSWR 1.20:1 @ 11 GHz 1.30:1 @ 18 GHz</p>	PRICE		1-24	\$177.18	25-49	\$164.78	50-99	\$152.37	100 +	\$141.74	 <table border="1"> <thead> <tr> <th colspan="2">PRICE</th> </tr> </thead> <tbody> <tr> <td>1-24</td> <td>\$17.52</td> </tr> <tr> <td>25-49</td> <td>\$16.29</td> </tr> <tr> <td>50-99</td> <td>\$15.07</td> </tr> <tr> <td>100 +</td> <td>\$14.02</td> </tr> </tbody> </table> <p>Model No: PE9086</p> <p>N Male To N Female Right Angle</p>	PRICE		1-24	\$17.52	25-49	\$16.29	50-99	\$15.07	100 +	\$14.02	 <table border="1"> <thead> <tr> <th colspan="2">PRICE</th> </tr> </thead> <tbody> <tr> <td>1-24</td> <td>\$78.23</td> </tr> <tr> <td>25-49</td> <td>\$72.75</td> </tr> <tr> <td>50-99</td> <td>\$67.28</td> </tr> <tr> <td>100 +</td> <td>\$62.58</td> </tr> </tbody> </table> <p>PRECISION</p> <p>Model No: PE9428</p> <p>N Female To N Female Max VSWR 1.15:1 @ 18 GHz</p>	PRICE		1-24	\$78.23	25-49	\$72.75	50-99	\$67.28	100 +	\$62.58
	PRICE																																											
1-24	\$33.08																																											
25-49	\$30.76																																											
50-99	\$28.45																																											
100 +	\$26.46																																											
PRICE																																												
1-24	\$177.18																																											
25-49	\$164.78																																											
50-99	\$152.37																																											
100 +	\$141.74																																											
PRICE																																												
1-24	\$17.52																																											
25-49	\$16.29																																											
50-99	\$15.07																																											
100 +	\$14.02																																											
PRICE																																												
1-24	\$78.23																																											
25-49	\$72.75																																											
50-99	\$67.28																																											
100 +	\$62.58																																											
3	 <table border="1"> <thead> <tr> <th colspan="2">PRICE</th> </tr> </thead> <tbody> <tr> <td>1-24</td> <td>\$35.00</td> </tr> <tr> <td>25-49</td> <td>\$32.55</td> </tr> <tr> <td>50-99</td> <td>\$30.10</td> </tr> <tr> <td>100 +</td> <td>\$28.00</td> </tr> </tbody> </table> <p>PRECISION NEW</p> <p>Model No: PE91035</p> <p>N Female To N Female Low PIM, Low VSWR</p>	PRICE		1-24	\$35.00	25-49	\$32.55	50-99	\$30.10	100 +	\$28.00	 <table border="1"> <thead> <tr> <th colspan="2">PRICE</th> </tr> </thead> <tbody> <tr> <td>1-24</td> <td>\$143.23</td> </tr> <tr> <td>25-49</td> <td>\$133.20</td> </tr> <tr> <td>50-99</td> <td>\$123.18</td> </tr> <tr> <td>100 +</td> <td>\$114.58</td> </tr> </tbody> </table> <p>PRECISION</p> <p>Model No: PE9500</p> <p>N Female To N Female Bulkhead Max VSWR 1.15:1 @ 18 GHz Mounting Hole G01</p>	PRICE		1-24	\$143.23	25-49	\$133.20	50-99	\$123.18	100 +	\$114.58	 <table border="1"> <thead> <tr> <th colspan="2">PRICE</th> </tr> </thead> <tbody> <tr> <td>1-24</td> <td>\$92.56</td> </tr> <tr> <td>25-49</td> <td>\$86.08</td> </tr> <tr> <td>50-99</td> <td>\$79.60</td> </tr> <tr> <td>100 +</td> <td>\$74.05</td> </tr> </tbody> </table> <p>PRECISION</p> <p>Model No: PE9429</p> <p>N Female To N Female Panel Mount Max VSWR 1.15:1 @ 18 GHz Mounting Hole A05</p>	PRICE		1-24	\$92.56	25-49	\$86.08	50-99	\$79.60	100 +	\$74.05	 <table border="1"> <thead> <tr> <th colspan="2">PRICE</th> </tr> </thead> <tbody> <tr> <td>1-24</td> <td>\$11.70</td> </tr> <tr> <td>25-49</td> <td>\$10.88</td> </tr> <tr> <td>50-99</td> <td>\$10.06</td> </tr> <tr> <td>100 +</td> <td>\$9.36</td> </tr> </tbody> </table> <p>Model No: PE9006</p> <p>N Female To N Female</p>	PRICE		1-24	\$11.70	25-49	\$10.88	50-99	\$10.06	100 +	\$9.36
	PRICE																																											
1-24	\$35.00																																											
25-49	\$32.55																																											
50-99	\$30.10																																											
100 +	\$28.00																																											
PRICE																																												
1-24	\$143.23																																											
25-49	\$133.20																																											
50-99	\$123.18																																											
100 +	\$114.58																																											
PRICE																																												
1-24	\$92.56																																											
25-49	\$86.08																																											
50-99	\$79.60																																											
100 +	\$74.05																																											
PRICE																																												
1-24	\$11.70																																											
25-49	\$10.88																																											
50-99	\$10.06																																											
100 +	\$9.36																																											
4	 <table border="1"> <thead> <tr> <th colspan="2">PRICE</th> </tr> </thead> <tbody> <tr> <td>1-24</td> <td>\$18.46</td> </tr> <tr> <td>25-49</td> <td>\$17.17</td> </tr> <tr> <td>50-99</td> <td>\$15.88</td> </tr> <tr> <td>100 +</td> <td>\$14.77</td> </tr> </tbody> </table> <p>Model No: PE9128</p> <p>N Female To N Female Bulkhead Hermetically Sealed Mounting Hole G01</p>	PRICE		1-24	\$18.46	25-49	\$17.17	50-99	\$15.88	100 +	\$14.77	 <table border="1"> <thead> <tr> <th colspan="2">PRICE</th> </tr> </thead> <tbody> <tr> <td>1-24</td> <td>\$56.80</td> </tr> <tr> <td>25-49</td> <td>\$52.82</td> </tr> <tr> <td>50-99</td> <td>\$48.85</td> </tr> <tr> <td>100 +</td> <td>\$45.44</td> </tr> </tbody> </table> <p>Model No: PE9383</p> <p>N Female To N Female Bulkhead Hermetically Sealed For A 1" Max Panel Mounting Hole G01</p>	PRICE		1-24	\$56.80	25-49	\$52.82	50-99	\$48.85	100 +	\$45.44	 <table border="1"> <thead> <tr> <th colspan="2">PRICE</th> </tr> </thead> <tbody> <tr> <td>1-24</td> <td>\$31.36</td> </tr> <tr> <td>25-49</td> <td>\$29.16</td> </tr> <tr> <td>50-99</td> <td>\$26.97</td> </tr> <tr> <td>100 +</td> <td>\$25.09</td> </tr> </tbody> </table> <p>Model No: PE9382</p> <p>N Female To N Female Bulkhead Isolated Ground Mounting Hole G01</p>	PRICE		1-24	\$31.36	25-49	\$29.16	50-99	\$26.97	100 +	\$25.09	 <table border="1"> <thead> <tr> <th colspan="2">PRICE</th> </tr> </thead> <tbody> <tr> <td>1-24</td> <td>\$22.92</td> </tr> <tr> <td>25-49</td> <td>\$21.32</td> </tr> <tr> <td>50-99</td> <td>\$19.71</td> </tr> <tr> <td>100 +</td> <td>\$18.34</td> </tr> </tbody> </table> <p>Model No: PE9173</p> <p>N Female To N Female Panel Mount Mounting Hole A05</p>	PRICE		1-24	\$22.92	25-49	\$21.32	50-99	\$19.71	100 +	\$18.34
	PRICE																																											
1-24	\$18.46																																											
25-49	\$17.17																																											
50-99	\$15.88																																											
100 +	\$14.77																																											
PRICE																																												
1-24	\$56.80																																											
25-49	\$52.82																																											
50-99	\$48.85																																											
100 +	\$45.44																																											
PRICE																																												
1-24	\$31.36																																											
25-49	\$29.16																																											
50-99	\$26.97																																											
100 +	\$25.09																																											
PRICE																																												
1-24	\$22.92																																											
25-49	\$21.32																																											
50-99	\$19.71																																											
100 +	\$18.34																																											
5	 <table border="1"> <thead> <tr> <th colspan="2">PRICE</th> </tr> </thead> <tbody> <tr> <td>1-24</td> <td>\$34.71</td> </tr> <tr> <td>25-49</td> <td>\$32.28</td> </tr> <tr> <td>50-99</td> <td>\$29.85</td> </tr> <tr> <td>100 +</td> <td>\$27.77</td> </tr> </tbody> </table> <p>Model No: PE9359</p> <p>N Female To N Female Right Angle</p>	PRICE		1-24	\$34.71	25-49	\$32.28	50-99	\$29.85	100 +	\$27.77	 <table border="1"> <thead> <tr> <th colspan="2">PRICE</th> </tr> </thead> <tbody> <tr> <td>1-24</td> <td>\$57.81</td> </tr> <tr> <td>25-49</td> <td>\$53.76</td> </tr> <tr> <td>50-99</td> <td>\$49.72</td> </tr> <tr> <td>100 +</td> <td>\$46.25</td> </tr> </tbody> </table> <p>Model No: PE9541</p> <p>N Female To N Female Bulkhead Right Angle Mounting Hole G01</p>	PRICE		1-24	\$57.81	25-49	\$53.76	50-99	\$49.72	100 +	\$46.25	 <table border="1"> <thead> <tr> <th colspan="2">PRICE</th> </tr> </thead> <tbody> <tr> <td>1-24</td> <td>\$46.21</td> </tr> <tr> <td>25-49</td> <td>\$42.98</td> </tr> <tr> <td>50-99</td> <td>\$39.74</td> </tr> <tr> <td>100 +</td> <td>\$36.97</td> </tr> </tbody> </table> <p>Model No: PE9390</p> <p>N "T" Male-Male-Male</p>	PRICE		1-24	\$46.21	25-49	\$42.98	50-99	\$39.74	100 +	\$36.97	 <table border="1"> <thead> <tr> <th colspan="2">PRICE</th> </tr> </thead> <tbody> <tr> <td>1-24</td> <td>\$24.07</td> </tr> <tr> <td>25-49</td> <td>\$22.39</td> </tr> <tr> <td>50-99</td> <td>\$20.70</td> </tr> <tr> <td>100 +</td> <td>\$19.26</td> </tr> </tbody> </table> <p>Model No: PE9102</p> <p>N "T" Female-Male-Female</p>	PRICE		1-24	\$24.07	25-49	\$22.39	50-99	\$20.70	100 +	\$19.26
	PRICE																																											
1-24	\$34.71																																											
25-49	\$32.28																																											
50-99	\$29.85																																											
100 +	\$27.77																																											
PRICE																																												
1-24	\$57.81																																											
25-49	\$53.76																																											
50-99	\$49.72																																											
100 +	\$46.25																																											
PRICE																																												
1-24	\$46.21																																											
25-49	\$42.98																																											
50-99	\$39.74																																											
100 +	\$36.97																																											
PRICE																																												
1-24	\$24.07																																											
25-49	\$22.39																																											
50-99	\$20.70																																											
100 +	\$19.26																																											
6	 <table border="1"> <thead> <tr> <th colspan="2">PRICE</th> </tr> </thead> <tbody> <tr> <td>1-24</td> <td>\$57.81</td> </tr> <tr> <td>25-49</td> <td>\$53.76</td> </tr> <tr> <td>50-99</td> <td>\$49.72</td> </tr> <tr> <td>100 +</td> <td>\$46.25</td> </tr> </tbody> </table> <p>Model No: PE9481</p> <p>N "T" Male-Female-Female</p>	PRICE		1-24	\$57.81	25-49	\$53.76	50-99	\$49.72	100 +	\$46.25	 <table border="1"> <thead> <tr> <th colspan="2">PRICE</th> </tr> </thead> <tbody> <tr> <td>1-24</td> <td>\$21.66</td> </tr> <tr> <td>25-49</td> <td>\$20.14</td> </tr> <tr> <td>50-99</td> <td>\$18.63</td> </tr> <tr> <td>100 +</td> <td>\$17.33</td> </tr> </tbody> </table> <p>Model No: PE9101</p> <p>N "T" Female-Female-Female</p>	PRICE		1-24	\$21.66	25-49	\$20.14	50-99	\$18.63	100 +	\$17.33	 <table border="1"> <thead> <tr> <th colspan="2">PRICE</th> </tr> </thead> <tbody> <tr> <td>1-24</td> <td>\$58.87</td> </tr> <tr> <td>25-49</td> <td>\$54.75</td> </tr> <tr> <td>50-99</td> <td>\$50.63</td> </tr> <tr> <td>100 +</td> <td>\$47.10</td> </tr> </tbody> </table> <p>Model No: PE9549</p> <p>N Cross Female-Female-Female-Male</p>	PRICE		1-24	\$58.87	25-49	\$54.75	50-99	\$50.63	100 +	\$47.10	 <table border="1"> <thead> <tr> <th colspan="2">PRICE</th> </tr> </thead> <tbody> <tr> <td>1-24</td> <td>\$58.87</td> </tr> <tr> <td>25-49</td> <td>\$54.75</td> </tr> <tr> <td>50-99</td> <td>\$50.63</td> </tr> <tr> <td>100 +</td> <td>\$47.10</td> </tr> </tbody> </table> <p>Model No: PE9548</p> <p>N Cross Female-Female-Female-Female</p>	PRICE		1-24	\$58.87	25-49	\$54.75	50-99	\$50.63	100 +	\$47.10
	PRICE																																											
1-24	\$57.81																																											
25-49	\$53.76																																											
50-99	\$49.72																																											
100 +	\$46.25																																											
PRICE																																												
1-24	\$21.66																																											
25-49	\$20.14																																											
50-99	\$18.63																																											
100 +	\$17.33																																											
PRICE																																												
1-24	\$58.87																																											
25-49	\$54.75																																											
50-99	\$50.63																																											
100 +	\$47.10																																											
PRICE																																												
1-24	\$58.87																																											
25-49	\$54.75																																											
50-99	\$50.63																																											
100 +	\$47.10																																											

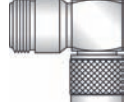
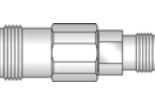
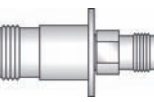
ROHS & REACH COMPLIANT. CUSTOM-LENGTH CABLE ASSEMBLIES MAY BE ORDERED ON OUR WEBSITE.

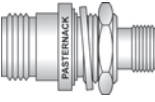
ADAPTERS

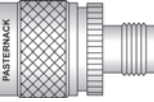
See Adapter Locator on Pages 140-145 or the Adapter Matrix on Pages 138-139

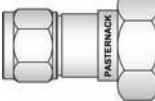
See Page 246 for Mounting Holes

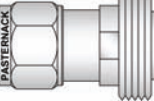
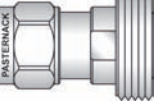
	A	B	C	D																																								
1	 <table border="1"> <thead> <tr> <th colspan="2">PRICE</th> </tr> </thead> <tbody> <tr> <td>1-24</td> <td>\$27.06</td> </tr> <tr> <td>25-49</td> <td>\$25.17</td> </tr> <tr> <td>50-99</td> <td>\$23.27</td> </tr> <tr> <td>100 +</td> <td>\$21.65</td> </tr> </tbody> </table> <p>Model No: PE9772 Reverse Polarity N Male To Reverse Polarity N Male</p>	PRICE		1-24	\$27.06	25-49	\$25.17	50-99	\$23.27	100 +	\$21.65	 <table border="1"> <thead> <tr> <th colspan="2">PRICE</th> </tr> </thead> <tbody> <tr> <td>1-24</td> <td>\$23.51</td> </tr> <tr> <td>25-49</td> <td>\$21.86</td> </tr> <tr> <td>50-99</td> <td>\$20.22</td> </tr> <tr> <td>100 +</td> <td>\$18.81</td> </tr> </tbody> </table> <p>Model No: PE9773 Reverse Polarity N Female To Reverse Polarity N Female</p>	PRICE		1-24	\$23.51	25-49	\$21.86	50-99	\$20.22	100 +	\$18.81	 <table border="1"> <thead> <tr> <th colspan="2">PRICE</th> </tr> </thead> <tbody> <tr> <td>1-24</td> <td>\$23.51</td> </tr> <tr> <td>25-49</td> <td>\$21.86</td> </tr> <tr> <td>50-99</td> <td>\$20.22</td> </tr> <tr> <td>100 +</td> <td>\$18.81</td> </tr> </tbody> </table> <p>Model No: PE9771 N Male To Reverse Polarity N Female</p>	PRICE		1-24	\$23.51	25-49	\$21.86	50-99	\$20.22	100 +	\$18.81	 <table border="1"> <thead> <tr> <th colspan="2">PRICE</th> </tr> </thead> <tbody> <tr> <td>1-24</td> <td>\$23.15</td> </tr> <tr> <td>25-49</td> <td>\$21.53</td> </tr> <tr> <td>50-99</td> <td>\$19.91</td> </tr> <tr> <td>100 +</td> <td>\$18.52</td> </tr> </tbody> </table> <p>Model No: PE9770 N Female To Reverse Polarity N Male</p>	PRICE		1-24	\$23.15	25-49	\$21.53	50-99	\$19.91	100 +	\$18.52
	PRICE																																											
1-24	\$27.06																																											
25-49	\$25.17																																											
50-99	\$23.27																																											
100 +	\$21.65																																											
PRICE																																												
1-24	\$23.51																																											
25-49	\$21.86																																											
50-99	\$20.22																																											
100 +	\$18.81																																											
PRICE																																												
1-24	\$23.51																																											
25-49	\$21.86																																											
50-99	\$20.22																																											
100 +	\$18.81																																											
PRICE																																												
1-24	\$23.15																																											
25-49	\$21.53																																											
50-99	\$19.91																																											
100 +	\$18.52																																											
2	<div style="background-color: black; color: white; padding: 10px; text-align: center;"> <h2 style="margin: 0;">N Between-Series</h2>  </div>																																											
	 <table border="1"> <thead> <tr> <th colspan="2">PRICE</th> </tr> </thead> <tbody> <tr> <td>1-24</td> <td>\$107.78</td> </tr> <tr> <td>25-49</td> <td>\$100.24</td> </tr> <tr> <td>50-99</td> <td>\$92.69</td> </tr> <tr> <td>100 +</td> <td>\$86.22</td> </tr> </tbody> </table> <p>PRECISION Model No: PE9446 N Male To TNC Male Max VSWR 1.15:1 @ 18 GHz</p>	PRICE		1-24	\$107.78	25-49	\$100.24	50-99	\$92.69	100 +	\$86.22	 <table border="1"> <thead> <tr> <th colspan="2">PRICE</th> </tr> </thead> <tbody> <tr> <td>1-24</td> <td>\$32.15</td> </tr> <tr> <td>25-49</td> <td>\$29.90</td> </tr> <tr> <td>50-99</td> <td>\$27.65</td> </tr> <tr> <td>100 +</td> <td>\$25.72</td> </tr> </tbody> </table> <p>Model No: PE9130 N Male To TNC Male</p>	PRICE		1-24	\$32.15	25-49	\$29.90	50-99	\$27.65	100 +	\$25.72	 <table border="1"> <thead> <tr> <th colspan="2">PRICE</th> </tr> </thead> <tbody> <tr> <td>1-24</td> <td>\$104.12</td> </tr> <tr> <td>25-49</td> <td>\$96.83</td> </tr> <tr> <td>50-99</td> <td>\$89.54</td> </tr> <tr> <td>100 +</td> <td>\$83.30</td> </tr> </tbody> </table> <p>PRECISION Model No: PE9448 N Male To TNC Female Max VSWR 1.15:1 @ 18 GHz</p>	PRICE		1-24	\$104.12	25-49	\$96.83	50-99	\$89.54	100 +	\$83.30											
PRICE																																												
1-24	\$107.78																																											
25-49	\$100.24																																											
50-99	\$92.69																																											
100 +	\$86.22																																											
PRICE																																												
1-24	\$32.15																																											
25-49	\$29.90																																											
50-99	\$27.65																																											
100 +	\$25.72																																											
PRICE																																												
1-24	\$104.12																																											
25-49	\$96.83																																											
50-99	\$89.54																																											
100 +	\$83.30																																											
3	 <table border="1"> <thead> <tr> <th colspan="2">PRICE</th> </tr> </thead> <tbody> <tr> <td>1-24</td> <td>\$20.88</td> </tr> <tr> <td>25-49</td> <td>\$19.42</td> </tr> <tr> <td>50-99</td> <td>\$17.96</td> </tr> <tr> <td>100 +</td> <td>\$16.70</td> </tr> </tbody> </table> <p>Model No: PE9090 N Male To TNC Female</p>	PRICE		1-24	\$20.88	25-49	\$19.42	50-99	\$17.96	100 +	\$16.70	 <table border="1"> <thead> <tr> <th colspan="2">PRICE</th> </tr> </thead> <tbody> <tr> <td>1-24</td> <td>\$57.81</td> </tr> <tr> <td>25-49</td> <td>\$53.76</td> </tr> <tr> <td>50-99</td> <td>\$49.72</td> </tr> <tr> <td>100 +</td> <td>\$46.25</td> </tr> </tbody> </table> <p>Model No: PE9550 N Male To TNC Female Right Angle</p>	PRICE		1-24	\$57.81	25-49	\$53.76	50-99	\$49.72	100 +	\$46.25	 <table border="1"> <thead> <tr> <th colspan="2">PRICE</th> </tr> </thead> <tbody> <tr> <td>1-24</td> <td>\$104.12</td> </tr> <tr> <td>25-49</td> <td>\$96.83</td> </tr> <tr> <td>50-99</td> <td>\$89.54</td> </tr> <tr> <td>100 +</td> <td>\$83.30</td> </tr> </tbody> </table> <p>PRECISION Model No: PE9447 N Female To TNC Male Max VSWR 1.15:1 @ 18 GHz</p>	PRICE		1-24	\$104.12	25-49	\$96.83	50-99	\$89.54	100 +	\$83.30	 <table border="1"> <thead> <tr> <th colspan="2">PRICE</th> </tr> </thead> <tbody> <tr> <td>1-24</td> <td>\$21.82</td> </tr> <tr> <td>25-49</td> <td>\$20.29</td> </tr> <tr> <td>50-99</td> <td>\$18.77</td> </tr> <tr> <td>100 +</td> <td>\$17.46</td> </tr> </tbody> </table> <p>Model No: PE9089 N Female To TNC Male</p>	PRICE		1-24	\$21.82	25-49	\$20.29	50-99	\$18.77	100 +	\$17.46
	PRICE																																											
1-24	\$20.88																																											
25-49	\$19.42																																											
50-99	\$17.96																																											
100 +	\$16.70																																											
PRICE																																												
1-24	\$57.81																																											
25-49	\$53.76																																											
50-99	\$49.72																																											
100 +	\$46.25																																											
PRICE																																												
1-24	\$104.12																																											
25-49	\$96.83																																											
50-99	\$89.54																																											
100 +	\$83.30																																											
PRICE																																												
1-24	\$21.82																																											
25-49	\$20.29																																											
50-99	\$18.77																																											
100 +	\$17.46																																											
4	 <table border="1"> <thead> <tr> <th colspan="2">PRICE</th> </tr> </thead> <tbody> <tr> <td>1-24</td> <td>\$47.42</td> </tr> <tr> <td>25-49</td> <td>\$44.10</td> </tr> <tr> <td>50-99</td> <td>\$40.78</td> </tr> <tr> <td>100 +</td> <td>\$37.94</td> </tr> </tbody> </table> <p>Model No: PE9263 N Female To TNC Male Right Angle</p>	PRICE		1-24	\$47.42	25-49	\$44.10	50-99	\$40.78	100 +	\$37.94	 <table border="1"> <thead> <tr> <th colspan="2">PRICE</th> </tr> </thead> <tbody> <tr> <td>1-24</td> <td>\$110.04</td> </tr> <tr> <td>25-49</td> <td>\$102.34</td> </tr> <tr> <td>50-99</td> <td>\$94.63</td> </tr> <tr> <td>100 +</td> <td>\$88.03</td> </tr> </tbody> </table> <p>PRECISION Model No: PE9449 N Female To TNC Female Max VSWR 1.15:1 @ 18 GHz</p>	PRICE		1-24	\$110.04	25-49	\$102.34	50-99	\$94.63	100 +	\$88.03	 <table border="1"> <thead> <tr> <th colspan="2">PRICE</th> </tr> </thead> <tbody> <tr> <td>1-24</td> <td>\$104.12</td> </tr> <tr> <td>25-49</td> <td>\$96.83</td> </tr> <tr> <td>50-99</td> <td>\$89.54</td> </tr> <tr> <td>100 +</td> <td>\$83.30</td> </tr> </tbody> </table> <p>PRECISION Model No: PE9450 N Female To TNC Female Panel Mount Max VSWR 1.15:1 @ 18 GHz Mounting Hole A05</p>	PRICE		1-24	\$104.12	25-49	\$96.83	50-99	\$89.54	100 +	\$83.30	 <table border="1"> <thead> <tr> <th colspan="2">PRICE</th> </tr> </thead> <tbody> <tr> <td>1-24</td> <td>\$34.62</td> </tr> <tr> <td>25-49</td> <td>\$32.20</td> </tr> <tr> <td>50-99</td> <td>\$29.77</td> </tr> <tr> <td>100 +</td> <td>\$27.70</td> </tr> </tbody> </table> <p>Model No: PE9131 N Female To TNC Female</p>	PRICE		1-24	\$34.62	25-49	\$32.20	50-99	\$29.77	100 +	\$27.70
	PRICE																																											
1-24	\$47.42																																											
25-49	\$44.10																																											
50-99	\$40.78																																											
100 +	\$37.94																																											
PRICE																																												
1-24	\$110.04																																											
25-49	\$102.34																																											
50-99	\$94.63																																											
100 +	\$88.03																																											
PRICE																																												
1-24	\$104.12																																											
25-49	\$96.83																																											
50-99	\$89.54																																											
100 +	\$83.30																																											
PRICE																																												
1-24	\$34.62																																											
25-49	\$32.20																																											
50-99	\$29.77																																											
100 +	\$27.70																																											
5	 <table border="1"> <thead> <tr> <th colspan="2">PRICE</th> </tr> </thead> <tbody> <tr> <td>1-24</td> <td>\$33.79</td> </tr> <tr> <td>25-49</td> <td>\$31.42</td> </tr> <tr> <td>50-99</td> <td>\$29.06</td> </tr> <tr> <td>100 +</td> <td>\$27.03</td> </tr> </tbody> </table> <p>Model No: PE9482 N Female To TNC Female Bulkhead Mounting Hole G01</p>	PRICE		1-24	\$33.79	25-49	\$31.42	50-99	\$29.06	100 +	\$27.03	 <table border="1"> <thead> <tr> <th colspan="2">PRICE</th> </tr> </thead> <tbody> <tr> <td>1-24</td> <td>\$58.87</td> </tr> <tr> <td>25-49</td> <td>\$54.75</td> </tr> <tr> <td>50-99</td> <td>\$50.63</td> </tr> <tr> <td>100 +</td> <td>\$47.10</td> </tr> </tbody> </table> <p>Model No: PE9552 N Female To TNC Female Panel Mount Mounting Hole A05</p>	PRICE		1-24	\$58.87	25-49	\$54.75	50-99	\$50.63	100 +	\$47.10	 <table border="1"> <thead> <tr> <th colspan="2">PRICE</th> </tr> </thead> <tbody> <tr> <td>1-24</td> <td>\$34.50</td> </tr> <tr> <td>25-49</td> <td>\$32.09</td> </tr> <tr> <td>50-99</td> <td>\$29.67</td> </tr> <tr> <td>100 +</td> <td>\$27.60</td> </tr> </tbody> </table> <p>Model No: PE9730 N Male To Reverse Polarity TNC Female</p>	PRICE		1-24	\$34.50	25-49	\$32.09	50-99	\$29.67	100 +	\$27.60	 <table border="1"> <thead> <tr> <th colspan="2">PRICE</th> </tr> </thead> <tbody> <tr> <td>1-24</td> <td>\$31.72</td> </tr> <tr> <td>25-49</td> <td>\$29.50</td> </tr> <tr> <td>50-99</td> <td>\$27.28</td> </tr> <tr> <td>100 +</td> <td>\$25.38</td> </tr> </tbody> </table> <p>Model No: PE9731 N Female To Reverse Polarity TNC Male</p>	PRICE		1-24	\$31.72	25-49	\$29.50	50-99	\$27.28	100 +	\$25.38
	PRICE																																											
1-24	\$33.79																																											
25-49	\$31.42																																											
50-99	\$29.06																																											
100 +	\$27.03																																											
PRICE																																												
1-24	\$58.87																																											
25-49	\$54.75																																											
50-99	\$50.63																																											
100 +	\$47.10																																											
PRICE																																												
1-24	\$34.50																																											
25-49	\$32.09																																											
50-99	\$29.67																																											
100 +	\$27.60																																											
PRICE																																												
1-24	\$31.72																																											
25-49	\$29.50																																											
50-99	\$27.28																																											
100 +	\$25.38																																											
6	 <table border="1"> <thead> <tr> <th colspan="2">PRICE</th> </tr> </thead> <tbody> <tr> <td>1-24</td> <td>\$65.00</td> </tr> <tr> <td>25-49</td> <td>\$60.45</td> </tr> <tr> <td>50-99</td> <td>\$55.90</td> </tr> <tr> <td>100 +</td> <td>\$52.00</td> </tr> </tbody> </table> <p>PRECISION NEW Model No: PE91030 N Male To 7/16 Male Low PIM, Low VSWR</p>	PRICE		1-24	\$65.00	25-49	\$60.45	50-99	\$55.90	100 +	\$52.00	 <table border="1"> <thead> <tr> <th colspan="2">PRICE</th> </tr> </thead> <tbody> <tr> <td>1-24</td> <td>\$140.29</td> </tr> <tr> <td>25-49</td> <td>\$130.47</td> </tr> <tr> <td>50-99</td> <td>\$120.65</td> </tr> <tr> <td>100 +</td> <td>\$112.23</td> </tr> </tbody> </table> <p>Model No: PE9535 N Male To 7/16 Male</p>	PRICE		1-24	\$140.29	25-49	\$130.47	50-99	\$120.65	100 +	\$112.23	 <table border="1"> <thead> <tr> <th colspan="2">PRICE</th> </tr> </thead> <tbody> <tr> <td>1-24</td> <td>\$65.00</td> </tr> <tr> <td>25-49</td> <td>\$60.45</td> </tr> <tr> <td>50-99</td> <td>\$55.90</td> </tr> <tr> <td>100 +</td> <td>\$52.00</td> </tr> </tbody> </table> <p>PRECISION NEW Model No: PE91032 N Male To 7/16 Female Low PIM, Low VSWR</p>	PRICE		1-24	\$65.00	25-49	\$60.45	50-99	\$55.90	100 +	\$52.00	 <table border="1"> <thead> <tr> <th colspan="2">PRICE</th> </tr> </thead> <tbody> <tr> <td>1-24</td> <td>\$82.99</td> </tr> <tr> <td>25-49</td> <td>\$77.18</td> </tr> <tr> <td>50-99</td> <td>\$71.37</td> </tr> <tr> <td>100 +</td> <td>\$66.39</td> </tr> </tbody> </table> <p>Model No: PE9178 N Male To 7/16 Female</p>	PRICE		1-24	\$82.99	25-49	\$77.18	50-99	\$71.37	100 +	\$66.39
	PRICE																																											
1-24	\$65.00																																											
25-49	\$60.45																																											
50-99	\$55.90																																											
100 +	\$52.00																																											
PRICE																																												
1-24	\$140.29																																											
25-49	\$130.47																																											
50-99	\$120.65																																											
100 +	\$112.23																																											
PRICE																																												
1-24	\$65.00																																											
25-49	\$60.45																																											
50-99	\$55.90																																											
100 +	\$52.00																																											
PRICE																																												
1-24	\$82.99																																											
25-49	\$77.18																																											
50-99	\$71.37																																											
100 +	\$66.39																																											

Adapters

See Our Website For Real-Time Stock Availability!











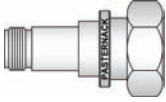
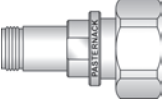
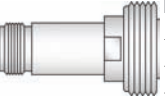

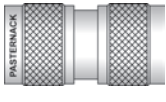
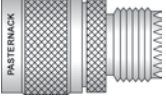
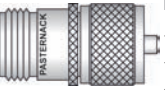
ADAPTERS

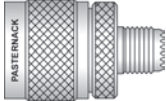
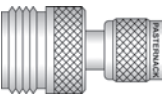
See Adapter Locator on Pages 140-145 or the Adapter Matrix on Pages 138-139

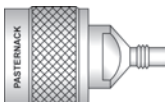
See Page 246 for Mounting Holes

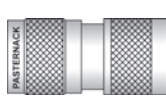
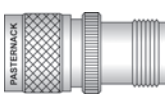
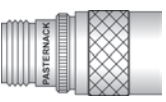
Adapters

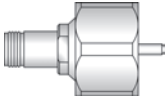
See Our Website For Real-Time Stock Availability!

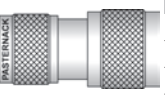
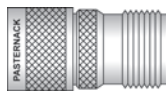









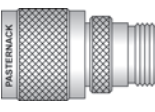

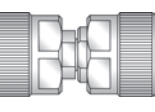

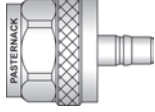
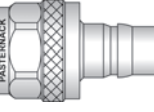

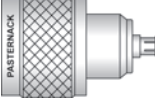

	A	B	C	D																																								
1	 <table border="1"> <thead> <tr> <th colspan="2">PRICE</th> </tr> </thead> <tbody> <tr> <td>1-24</td> <td>\$75.00</td> </tr> <tr> <td>25-49</td> <td>\$69.75</td> </tr> <tr> <td>50-99</td> <td>\$64.50</td> </tr> <tr> <td>100 +</td> <td>\$60.00</td> </tr> </tbody> </table> <p>PRECISION NEW Model No: PE91031 N Female To 7/16 Male Low PIM, Low VSWR</p>	PRICE		1-24	\$75.00	25-49	\$69.75	50-99	\$64.50	100 +	\$60.00	 <table border="1"> <thead> <tr> <th colspan="2">PRICE</th> </tr> </thead> <tbody> <tr> <td>1-24</td> <td>\$104.52</td> </tr> <tr> <td>25-49</td> <td>\$97.20</td> </tr> <tr> <td>50-99</td> <td>\$89.89</td> </tr> <tr> <td>100 +</td> <td>\$83.62</td> </tr> </tbody> </table> <p>Model No: PE9179 N Female To 7/16 Male</p>	PRICE		1-24	\$104.52	25-49	\$97.20	50-99	\$89.89	100 +	\$83.62	 <table border="1"> <thead> <tr> <th colspan="2">PRICE</th> </tr> </thead> <tbody> <tr> <td>1-24</td> <td>\$65.00</td> </tr> <tr> <td>25-49</td> <td>\$60.45</td> </tr> <tr> <td>50-99</td> <td>\$55.90</td> </tr> <tr> <td>100 +</td> <td>\$52.00</td> </tr> </tbody> </table> <p>PRECISION NEW Model No: PE91033 N Female To 7/16 Female Low PIM, Low VSWR</p>	PRICE		1-24	\$65.00	25-49	\$60.45	50-99	\$55.90	100 +	\$52.00	 <table border="1"> <thead> <tr> <th colspan="2">PRICE</th> </tr> </thead> <tbody> <tr> <td>1-24</td> <td>\$98.34</td> </tr> <tr> <td>25-49</td> <td>\$91.46</td> </tr> <tr> <td>50-99</td> <td>\$84.57</td> </tr> <tr> <td>100 +</td> <td>\$78.67</td> </tr> </tbody> </table> <p>Model No: PE9180 N Female To 7/16 Female</p>	PRICE		1-24	\$98.34	25-49	\$91.46	50-99	\$84.57	100 +	\$78.67
	PRICE																																											
1-24	\$75.00																																											
25-49	\$69.75																																											
50-99	\$64.50																																											
100 +	\$60.00																																											
PRICE																																												
1-24	\$104.52																																											
25-49	\$97.20																																											
50-99	\$89.89																																											
100 +	\$83.62																																											
PRICE																																												
1-24	\$65.00																																											
25-49	\$60.45																																											
50-99	\$55.90																																											
100 +	\$52.00																																											
PRICE																																												
1-24	\$98.34																																											
25-49	\$91.46																																											
50-99	\$84.57																																											
100 +	\$78.67																																											
2	 <table border="1"> <thead> <tr> <th colspan="2">PRICE</th> </tr> </thead> <tbody> <tr> <td>1-24</td> <td>\$22.95</td> </tr> <tr> <td>25-49</td> <td>\$21.34</td> </tr> <tr> <td>50-99</td> <td>\$19.74</td> </tr> <tr> <td>100 +</td> <td>\$18.36</td> </tr> </tbody> </table> <p>Model No: PE9113 N Male To UHF Male</p>	PRICE		1-24	\$22.95	25-49	\$21.34	50-99	\$19.74	100 +	\$18.36	 <table border="1"> <thead> <tr> <th colspan="2">PRICE</th> </tr> </thead> <tbody> <tr> <td>1-24</td> <td>\$21.66</td> </tr> <tr> <td>25-49</td> <td>\$20.14</td> </tr> <tr> <td>50-99</td> <td>\$18.63</td> </tr> <tr> <td>100 +</td> <td>\$17.33</td> </tr> </tbody> </table> <p>Model No: PE9111 N Male To UHF Female</p>	PRICE		1-24	\$21.66	25-49	\$20.14	50-99	\$18.63	100 +	\$17.33	 <table border="1"> <thead> <tr> <th colspan="2">PRICE</th> </tr> </thead> <tbody> <tr> <td>1-24</td> <td>\$18.62</td> </tr> <tr> <td>25-49</td> <td>\$17.32</td> </tr> <tr> <td>50-99</td> <td>\$16.01</td> </tr> <tr> <td>100 +</td> <td>\$14.90</td> </tr> </tbody> </table> <p>Model No: PE9112 N Female To UHF Male</p>	PRICE		1-24	\$18.62	25-49	\$17.32	50-99	\$16.01	100 +	\$14.90	 <table border="1"> <thead> <tr> <th colspan="2">PRICE</th> </tr> </thead> <tbody> <tr> <td>1-24</td> <td>\$16.87</td> </tr> <tr> <td>25-49</td> <td>\$15.69</td> </tr> <tr> <td>50-99</td> <td>\$14.51</td> </tr> <tr> <td>100 +</td> <td>\$13.50</td> </tr> </tbody> </table> <p>Model No: PE9385 N Female To UHF Female</p>	PRICE		1-24	\$16.87	25-49	\$15.69	50-99	\$14.51	100 +	\$13.50
	PRICE																																											
1-24	\$22.95																																											
25-49	\$21.34																																											
50-99	\$19.74																																											
100 +	\$18.36																																											
PRICE																																												
1-24	\$21.66																																											
25-49	\$20.14																																											
50-99	\$18.63																																											
100 +	\$17.33																																											
PRICE																																												
1-24	\$18.62																																											
25-49	\$17.32																																											
50-99	\$16.01																																											
100 +	\$14.90																																											
PRICE																																												
1-24	\$16.87																																											
25-49	\$15.69																																											
50-99	\$14.51																																											
100 +	\$13.50																																											
3	 <table border="1"> <thead> <tr> <th colspan="2">PRICE</th> </tr> </thead> <tbody> <tr> <td>1-24</td> <td>\$13.22</td> </tr> <tr> <td>25-49</td> <td>\$12.29</td> </tr> <tr> <td>50-99</td> <td>\$11.37</td> </tr> <tr> <td>100 +</td> <td>\$10.58</td> </tr> </tbody> </table> <p>Model No: PE9064 N Male To Mini UHF Female</p>	PRICE		1-24	\$13.22	25-49	\$12.29	50-99	\$11.37	100 +	\$10.58	 <table border="1"> <thead> <tr> <th colspan="2">PRICE</th> </tr> </thead> <tbody> <tr> <td>1-24</td> <td>\$15.66</td> </tr> <tr> <td>25-49</td> <td>\$14.56</td> </tr> <tr> <td>50-99</td> <td>\$13.47</td> </tr> <tr> <td>100 +</td> <td>\$12.53</td> </tr> </tbody> </table> <p>Model No: PE9183 N Female To Mini UHF Male</p>	PRICE		1-24	\$15.66	25-49	\$14.56	50-99	\$13.47	100 +	\$12.53	 <table border="1"> <thead> <tr> <th colspan="2">PRICE</th> </tr> </thead> <tbody> <tr> <td>1-24</td> <td>\$11.70</td> </tr> <tr> <td>25-49</td> <td>\$10.88</td> </tr> <tr> <td>50-99</td> <td>\$10.06</td> </tr> <tr> <td>100 +</td> <td>\$9.36</td> </tr> </tbody> </table> <p>Model No: PE9704 N Male To FME Plug</p>	PRICE		1-24	\$11.70	25-49	\$10.88	50-99	\$10.06	100 +	\$9.36	 <table border="1"> <thead> <tr> <th colspan="2">PRICE</th> </tr> </thead> <tbody> <tr> <td>1-24</td> <td>\$63.13</td> </tr> <tr> <td>25-49</td> <td>\$58.71</td> </tr> <tr> <td>50-99</td> <td>\$54.29</td> </tr> <tr> <td>100 +</td> <td>\$50.50</td> </tr> </tbody> </table> <p>Model No: PE9318 N Male To SMC Plug</p>	PRICE		1-24	\$63.13	25-49	\$58.71	50-99	\$54.29	100 +	\$50.50
	PRICE																																											
1-24	\$13.22																																											
25-49	\$12.29																																											
50-99	\$11.37																																											
100 +	\$10.58																																											
PRICE																																												
1-24	\$15.66																																											
25-49	\$14.56																																											
50-99	\$13.47																																											
100 +	\$12.53																																											
PRICE																																												
1-24	\$11.70																																											
25-49	\$10.88																																											
50-99	\$10.06																																											
100 +	\$9.36																																											
PRICE																																												
1-24	\$63.13																																											
25-49	\$58.71																																											
50-99	\$54.29																																											
100 +	\$50.50																																											
4	 <table border="1"> <thead> <tr> <th colspan="2">PRICE</th> </tr> </thead> <tbody> <tr> <td>1-24</td> <td>\$58.87</td> </tr> <tr> <td>25-49</td> <td>\$54.75</td> </tr> <tr> <td>50-99</td> <td>\$50.63</td> </tr> <tr> <td>100 +</td> <td>\$47.10</td> </tr> </tbody> </table> <p>Model No: PE9317 N Male To SMC Jack</p>	PRICE		1-24	\$58.87	25-49	\$54.75	50-99	\$50.63	100 +	\$47.10	 <table border="1"> <thead> <tr> <th colspan="2">PRICE</th> </tr> </thead> <tbody> <tr> <td>1-24</td> <td>\$58.87</td> </tr> <tr> <td>25-49</td> <td>\$54.75</td> </tr> <tr> <td>50-99</td> <td>\$50.63</td> </tr> <tr> <td>100 +</td> <td>\$47.10</td> </tr> </tbody> </table> <p>Model No: PE9320 N Female To SMC Plug</p>	PRICE		1-24	\$58.87	25-49	\$54.75	50-99	\$50.63	100 +	\$47.10	 <table border="1"> <thead> <tr> <th colspan="2">PRICE</th> </tr> </thead> <tbody> <tr> <td>1-24</td> <td>\$58.87</td> </tr> <tr> <td>25-49</td> <td>\$54.75</td> </tr> <tr> <td>50-99</td> <td>\$50.63</td> </tr> <tr> <td>100 +</td> <td>\$47.10</td> </tr> </tbody> </table> <p>Model No: PE9319 N Female To SMC Jack</p>	PRICE		1-24	\$58.87	25-49	\$54.75	50-99	\$50.63	100 +	\$47.10	 <table border="1"> <thead> <tr> <th colspan="2">PRICE</th> </tr> </thead> <tbody> <tr> <td>1-24</td> <td>\$83.70</td> </tr> <tr> <td>25-49</td> <td>\$77.84</td> </tr> <tr> <td>50-99</td> <td>\$71.98</td> </tr> <tr> <td>100 +</td> <td>\$66.96</td> </tr> </tbody> </table> <p>Model No: PE9570 N Male To SC Male</p>	PRICE		1-24	\$83.70	25-49	\$77.84	50-99	\$71.98	100 +	\$66.96
	PRICE																																											
1-24	\$58.87																																											
25-49	\$54.75																																											
50-99	\$50.63																																											
100 +	\$47.10																																											
PRICE																																												
1-24	\$58.87																																											
25-49	\$54.75																																											
50-99	\$50.63																																											
100 +	\$47.10																																											
PRICE																																												
1-24	\$58.87																																											
25-49	\$54.75																																											
50-99	\$50.63																																											
100 +	\$47.10																																											
PRICE																																												
1-24	\$83.70																																											
25-49	\$77.84																																											
50-99	\$71.98																																											
100 +	\$66.96																																											
5	 <table border="1"> <thead> <tr> <th colspan="2">PRICE</th> </tr> </thead> <tbody> <tr> <td>1-24</td> <td>\$83.82</td> </tr> <tr> <td>25-49</td> <td>\$77.95</td> </tr> <tr> <td>50-99</td> <td>\$72.09</td> </tr> <tr> <td>100 +</td> <td>\$67.06</td> </tr> </tbody> </table> <p>Model No: PE9196 N Male To SC Female</p>	PRICE		1-24	\$83.82	25-49	\$77.95	50-99	\$72.09	100 +	\$67.06	 <table border="1"> <thead> <tr> <th colspan="2">PRICE</th> </tr> </thead> <tbody> <tr> <td>1-24</td> <td>\$84.56</td> </tr> <tr> <td>25-49</td> <td>\$78.64</td> </tr> <tr> <td>50-99</td> <td>\$72.72</td> </tr> <tr> <td>100 +</td> <td>\$67.65</td> </tr> </tbody> </table> <p>Model No: PE9277 N Female To SC Male</p>	PRICE		1-24	\$84.56	25-49	\$78.64	50-99	\$72.72	100 +	\$67.65	 <table border="1"> <thead> <tr> <th colspan="2">PRICE</th> </tr> </thead> <tbody> <tr> <td>1-24</td> <td>\$80.96</td> </tr> <tr> <td>25-49</td> <td>\$75.29</td> </tr> <tr> <td>50-99</td> <td>\$69.63</td> </tr> <tr> <td>100 +</td> <td>\$64.77</td> </tr> </tbody> </table> <p>Model No: PE9292 N Female To SC Female</p>	PRICE		1-24	\$80.96	25-49	\$75.29	50-99	\$69.63	100 +	\$64.77	 <table border="1"> <thead> <tr> <th colspan="2">PRICE</th> </tr> </thead> <tbody> <tr> <td>1-24</td> <td>\$219.94</td> </tr> <tr> <td>25-49</td> <td>\$204.54</td> </tr> <tr> <td>50-99</td> <td>\$189.15</td> </tr> <tr> <td>100 +</td> <td>\$175.95</td> </tr> </tbody> </table> <p>Model No: PE9299 N Male To LC Female</p>	PRICE		1-24	\$219.94	25-49	\$204.54	50-99	\$189.15	100 +	\$175.95
	PRICE																																											
1-24	\$83.82																																											
25-49	\$77.95																																											
50-99	\$72.09																																											
100 +	\$67.06																																											
PRICE																																												
1-24	\$84.56																																											
25-49	\$78.64																																											
50-99	\$72.72																																											
100 +	\$67.65																																											
PRICE																																												
1-24	\$80.96																																											
25-49	\$75.29																																											
50-99	\$69.63																																											
100 +	\$64.77																																											
PRICE																																												
1-24	\$219.94																																											
25-49	\$204.54																																											
50-99	\$189.15																																											
100 +	\$175.95																																											
6	 <table border="1"> <thead> <tr> <th colspan="2">PRICE</th> </tr> </thead> <tbody> <tr> <td>1-24</td> <td>\$177.68</td> </tr> <tr> <td>25-49</td> <td>\$165.24</td> </tr> <tr> <td>50-99</td> <td>\$152.80</td> </tr> <tr> <td>100 +</td> <td>\$142.14</td> </tr> </tbody> </table> <p>Model No: PE9237 N Female To LC Male</p>	PRICE		1-24	\$177.68	25-49	\$165.24	50-99	\$152.80	100 +	\$142.14	 <table border="1"> <thead> <tr> <th colspan="2">PRICE</th> </tr> </thead> <tbody> <tr> <td>1-24</td> <td>\$184.93</td> </tr> <tr> <td>25-49</td> <td>\$171.98</td> </tr> <tr> <td>50-99</td> <td>\$159.04</td> </tr> <tr> <td>100 +</td> <td>\$147.94</td> </tr> </tbody> </table> <p>Model No: PE9298 N Female To LC Female</p>	PRICE		1-24	\$184.93	25-49	\$171.98	50-99	\$159.04	100 +	\$147.94	 <table border="1"> <thead> <tr> <th colspan="2">PRICE</th> </tr> </thead> <tbody> <tr> <td>1-24</td> <td>\$57.81</td> </tr> <tr> <td>25-49</td> <td>\$53.76</td> </tr> <tr> <td>50-99</td> <td>\$49.72</td> </tr> <tr> <td>100 +</td> <td>\$46.25</td> </tr> </tbody> </table> <p>Model No: PE9554 N Male To HN Male</p>	PRICE		1-24	\$57.81	25-49	\$53.76	50-99	\$49.72	100 +	\$46.25	 <table border="1"> <thead> <tr> <th colspan="2">PRICE</th> </tr> </thead> <tbody> <tr> <td>1-24</td> <td>\$38.97</td> </tr> <tr> <td>25-49</td> <td>\$36.24</td> </tr> <tr> <td>50-99</td> <td>\$33.51</td> </tr> <tr> <td>100 +</td> <td>\$31.18</td> </tr> </tbody> </table> <p>Model No: PE9125 N Male To HN Female</p>	PRICE		1-24	\$38.97	25-49	\$36.24	50-99	\$33.51	100 +	\$31.18
	PRICE																																											
1-24	\$177.68																																											
25-49	\$165.24																																											
50-99	\$152.80																																											
100 +	\$142.14																																											
PRICE																																												
1-24	\$184.93																																											
25-49	\$171.98																																											
50-99	\$159.04																																											
100 +	\$147.94																																											
PRICE																																												
1-24	\$57.81																																											
25-49	\$53.76																																											
50-99	\$49.72																																											
100 +	\$46.25																																											
PRICE																																												
1-24	\$38.97																																											
25-49	\$36.24																																											
50-99	\$33.51																																											
100 +	\$31.18																																											

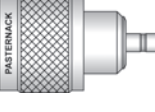
ROHS & REACH COMPLIANT. CUSTOM-LENGTH CABLE ASSEMBLIES MAY BE ORDERED ON OUR WEBSITE.

ADAPTERS

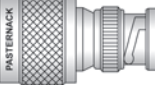
See Adapter Locator on Pages 140-145 or the Adapter Matrix on Pages 138-139

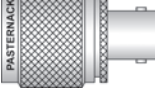
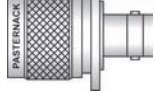
See Page 246 for Mounting Holes

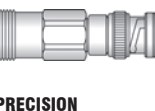
	A	B	C	D																																								
1	 <table border="1"> <thead> <tr> <th colspan="2">PRICE</th> </tr> </thead> <tbody> <tr> <td>1-24</td> <td>\$37.08</td> </tr> <tr> <td>25-49</td> <td>\$34.48</td> </tr> <tr> <td>50-99</td> <td>\$31.89</td> </tr> <tr> <td>100 +</td> <td>\$29.66</td> </tr> </tbody> </table> <p>Model No: PE9194 N Female To HN Male</p>	PRICE		1-24	\$37.08	25-49	\$34.48	50-99	\$31.89	100 +	\$29.66	 <table border="1"> <thead> <tr> <th colspan="2">PRICE</th> </tr> </thead> <tbody> <tr> <td>1-24</td> <td>\$55.53</td> </tr> <tr> <td>25-49</td> <td>\$51.64</td> </tr> <tr> <td>50-99</td> <td>\$47.76</td> </tr> <tr> <td>100 +</td> <td>\$44.42</td> </tr> </tbody> </table> <p>Model No: PE9360 N Female To HN Female</p>	PRICE		1-24	\$55.53	25-49	\$51.64	50-99	\$47.76	100 +	\$44.42	 <table border="1"> <thead> <tr> <th colspan="2">PRICE</th> </tr> </thead> <tbody> <tr> <td>1-24</td> <td>\$58.87</td> </tr> <tr> <td>25-49</td> <td>\$54.75</td> </tr> <tr> <td>50-99</td> <td>\$50.63</td> </tr> <tr> <td>100 +</td> <td>\$47.10</td> </tr> </tbody> </table> <p>Model No: PE9553 N Female To HN Female Panel Mount Mounting Hole A08</p>	PRICE		1-24	\$58.87	25-49	\$54.75	50-99	\$50.63	100 +	\$47.10	 <table border="1"> <thead> <tr> <th colspan="2">PRICE</th> </tr> </thead> <tbody> <tr> <td>1-24</td> <td>\$173.63</td> </tr> <tr> <td>25-49</td> <td>\$161.48</td> </tr> <tr> <td>50-99</td> <td>\$149.32</td> </tr> <tr> <td>100 +</td> <td>\$138.90</td> </tr> </tbody> </table> <p>PRECISION Model No: PE9217 N Male To 7mm Max VSWR 1.15:1 @ 18 GHz</p>	PRICE		1-24	\$173.63	25-49	\$161.48	50-99	\$149.32	100 +	\$138.90
	PRICE																																											
1-24	\$37.08																																											
25-49	\$34.48																																											
50-99	\$31.89																																											
100 +	\$29.66																																											
PRICE																																												
1-24	\$55.53																																											
25-49	\$51.64																																											
50-99	\$47.76																																											
100 +	\$44.42																																											
PRICE																																												
1-24	\$58.87																																											
25-49	\$54.75																																											
50-99	\$50.63																																											
100 +	\$47.10																																											
PRICE																																												
1-24	\$173.63																																											
25-49	\$161.48																																											
50-99	\$149.32																																											
100 +	\$138.90																																											
2	 <table border="1"> <thead> <tr> <th colspan="2">PRICE</th> </tr> </thead> <tbody> <tr> <td>1-24</td> <td>\$190.04</td> </tr> <tr> <td>25-49</td> <td>\$176.74</td> </tr> <tr> <td>50-99</td> <td>\$163.43</td> </tr> <tr> <td>100 +</td> <td>\$152.03</td> </tr> </tbody> </table> <p>PRECISION Model No: PE9216 N Female To 7mm Max VSWR 1.15:1 @ 18 GHz</p>	PRICE		1-24	\$190.04	25-49	\$176.74	50-99	\$163.43	100 +	\$152.03	 <table border="1"> <thead> <tr> <th colspan="2">PRICE</th> </tr> </thead> <tbody> <tr> <td>1-24</td> <td>\$101.33</td> </tr> <tr> <td>25-49</td> <td>\$94.24</td> </tr> <tr> <td>50-99</td> <td>\$87.14</td> </tr> <tr> <td>100 +</td> <td>\$81.06</td> </tr> </tbody> </table> <p>Model No: PE9787 N Male To QMA Female</p>	PRICE		1-24	\$101.33	25-49	\$94.24	50-99	\$87.14	100 +	\$81.06	 <table border="1"> <thead> <tr> <th colspan="2">PRICE</th> </tr> </thead> <tbody> <tr> <td>1-24</td> <td>\$101.33</td> </tr> <tr> <td>25-49</td> <td>\$94.24</td> </tr> <tr> <td>50-99</td> <td>\$87.14</td> </tr> <tr> <td>100 +</td> <td>\$81.06</td> </tr> </tbody> </table> <p>Model No: PE9789 N Male To QN Female</p>	PRICE		1-24	\$101.33	25-49	\$94.24	50-99	\$87.14	100 +	\$81.06	 <table border="1"> <thead> <tr> <th colspan="2">PRICE</th> </tr> </thead> <tbody> <tr> <td>1-24</td> <td>\$101.28</td> </tr> <tr> <td>25-49</td> <td>\$94.19</td> </tr> <tr> <td>50-99</td> <td>\$87.10</td> </tr> <tr> <td>100 +</td> <td>\$81.02</td> </tr> </tbody> </table> <p>Model No: PE9788 N Female To QN Male</p>	PRICE		1-24	\$101.28	25-49	\$94.19	50-99	\$87.10	100 +	\$81.02
	PRICE																																											
1-24	\$190.04																																											
25-49	\$176.74																																											
50-99	\$163.43																																											
100 +	\$152.03																																											
PRICE																																												
1-24	\$101.33																																											
25-49	\$94.24																																											
50-99	\$87.14																																											
100 +	\$81.06																																											
PRICE																																												
1-24	\$101.33																																											
25-49	\$94.24																																											
50-99	\$87.14																																											
100 +	\$81.06																																											
PRICE																																												
1-24	\$101.28																																											
25-49	\$94.19																																											
50-99	\$87.10																																											
100 +	\$81.02																																											
3	 <table border="1"> <thead> <tr> <th colspan="2">PRICE</th> </tr> </thead> <tbody> <tr> <td>1-24</td> <td>\$70.68</td> </tr> <tr> <td>25-49</td> <td>\$65.73</td> </tr> <tr> <td>50-99</td> <td>\$60.78</td> </tr> <tr> <td>100 +</td> <td>\$56.54</td> </tr> </tbody> </table> <p>Model No: PE9465 N Male To MCX Plug</p>	PRICE		1-24	\$70.68	25-49	\$65.73	50-99	\$60.78	100 +	\$56.54	 <table border="1"> <thead> <tr> <th colspan="2">PRICE</th> </tr> </thead> <tbody> <tr> <td>1-24</td> <td>\$70.68</td> </tr> <tr> <td>25-49</td> <td>\$65.73</td> </tr> <tr> <td>50-99</td> <td>\$60.78</td> </tr> <tr> <td>100 +</td> <td>\$56.54</td> </tr> </tbody> </table> <p>Model No: PE9464 N Male To MCX Jack</p>	PRICE		1-24	\$70.68	25-49	\$65.73	50-99	\$60.78	100 +	\$56.54	 <table border="1"> <thead> <tr> <th colspan="2">PRICE</th> </tr> </thead> <tbody> <tr> <td>1-24</td> <td>\$70.68</td> </tr> <tr> <td>25-49</td> <td>\$65.73</td> </tr> <tr> <td>50-99</td> <td>\$60.78</td> </tr> <tr> <td>100 +</td> <td>\$56.54</td> </tr> </tbody> </table> <p>Model No: PE9463 N Female To MCX Plug</p>	PRICE		1-24	\$70.68	25-49	\$65.73	50-99	\$60.78	100 +	\$56.54	 <table border="1"> <thead> <tr> <th colspan="2">PRICE</th> </tr> </thead> <tbody> <tr> <td>1-24</td> <td>\$70.68</td> </tr> <tr> <td>25-49</td> <td>\$65.73</td> </tr> <tr> <td>50-99</td> <td>\$60.78</td> </tr> <tr> <td>100 +</td> <td>\$56.54</td> </tr> </tbody> </table> <p>Model No: PE9462 N Female To MCX Jack</p>	PRICE		1-24	\$70.68	25-49	\$65.73	50-99	\$60.78	100 +	\$56.54
	PRICE																																											
1-24	\$70.68																																											
25-49	\$65.73																																											
50-99	\$60.78																																											
100 +	\$56.54																																											
PRICE																																												
1-24	\$70.68																																											
25-49	\$65.73																																											
50-99	\$60.78																																											
100 +	\$56.54																																											
PRICE																																												
1-24	\$70.68																																											
25-49	\$65.73																																											
50-99	\$60.78																																											
100 +	\$56.54																																											
PRICE																																												
1-24	\$70.68																																											
25-49	\$65.73																																											
50-99	\$60.78																																											
100 +	\$56.54																																											
4	 <table border="1"> <thead> <tr> <th colspan="2">PRICE</th> </tr> </thead> <tbody> <tr> <td>1-24</td> <td>\$48.08</td> </tr> <tr> <td>25-49</td> <td>\$44.71</td> </tr> <tr> <td>50-99</td> <td>\$41.35</td> </tr> <tr> <td>100 +</td> <td>\$38.46</td> </tr> </tbody> </table> <p>Model No: PE9314 N Male To SMB Plug</p>	PRICE		1-24	\$48.08	25-49	\$44.71	50-99	\$41.35	100 +	\$38.46	 <table border="1"> <thead> <tr> <th colspan="2">PRICE</th> </tr> </thead> <tbody> <tr> <td>1-24</td> <td>\$46.21</td> </tr> <tr> <td>25-49</td> <td>\$42.98</td> </tr> <tr> <td>50-99</td> <td>\$39.74</td> </tr> <tr> <td>100 +</td> <td>\$36.97</td> </tr> </tbody> </table> <p>Model No: PE9313 N Male To SMB Jack</p>	PRICE		1-24	\$46.21	25-49	\$42.98	50-99	\$39.74	100 +	\$36.97	 <table border="1"> <thead> <tr> <th colspan="2">PRICE</th> </tr> </thead> <tbody> <tr> <td>1-24</td> <td>\$47.12</td> </tr> <tr> <td>25-49</td> <td>\$43.82</td> </tr> <tr> <td>50-99</td> <td>\$40.52</td> </tr> <tr> <td>100 +</td> <td>\$37.70</td> </tr> </tbody> </table> <p>Model No: PE9316 N Female To SMB Plug</p>	PRICE		1-24	\$47.12	25-49	\$43.82	50-99	\$40.52	100 +	\$37.70	 <table border="1"> <thead> <tr> <th colspan="2">PRICE</th> </tr> </thead> <tbody> <tr> <td>1-24</td> <td>\$47.12</td> </tr> <tr> <td>25-49</td> <td>\$43.82</td> </tr> <tr> <td>50-99</td> <td>\$40.52</td> </tr> <tr> <td>100 +</td> <td>\$37.70</td> </tr> </tbody> </table> <p>Model No: PE9315 N Female To SMB Jack</p>	PRICE		1-24	\$47.12	25-49	\$43.82	50-99	\$40.52	100 +	\$37.70
	PRICE																																											
1-24	\$48.08																																											
25-49	\$44.71																																											
50-99	\$41.35																																											
100 +	\$38.46																																											
PRICE																																												
1-24	\$46.21																																											
25-49	\$42.98																																											
50-99	\$39.74																																											
100 +	\$36.97																																											
PRICE																																												
1-24	\$47.12																																											
25-49	\$43.82																																											
50-99	\$40.52																																											
100 +	\$37.70																																											
PRICE																																												
1-24	\$47.12																																											
25-49	\$43.82																																											
50-99	\$40.52																																											
100 +	\$37.70																																											
5	 <table border="1"> <thead> <tr> <th colspan="2">PRICE</th> </tr> </thead> <tbody> <tr> <td>1-24</td> <td>\$106.35</td> </tr> <tr> <td>25-49</td> <td>\$98.91</td> </tr> <tr> <td>50-99</td> <td>\$91.46</td> </tr> <tr> <td>100 +</td> <td>\$85.08</td> </tr> </tbody> </table> <p>PRECISION Model No: PE9489 N Male To BNC Male VSWR 1.20:1 @ 8 GHz</p>	PRICE		1-24	\$106.35	25-49	\$98.91	50-99	\$91.46	100 +	\$85.08	 <table border="1"> <thead> <tr> <th colspan="2">PRICE</th> </tr> </thead> <tbody> <tr> <td>1-24</td> <td>\$31.77</td> </tr> <tr> <td>25-49</td> <td>\$29.55</td> </tr> <tr> <td>50-99</td> <td>\$27.32</td> </tr> <tr> <td>100 +</td> <td>\$25.42</td> </tr> </tbody> </table> <p>Model No: PE9127 N Male To BNC Male</p>	PRICE		1-24	\$31.77	25-49	\$29.55	50-99	\$27.32	100 +	\$25.42	 <table border="1"> <thead> <tr> <th colspan="2">PRICE</th> </tr> </thead> <tbody> <tr> <td>1-24</td> <td>\$70.68</td> </tr> <tr> <td>25-49</td> <td>\$65.73</td> </tr> <tr> <td>50-99</td> <td>\$60.78</td> </tr> <tr> <td>100 +</td> <td>\$56.54</td> </tr> </tbody> </table> <p>Model No: PE9565 N Male To BNC Male Right Angle</p>	PRICE		1-24	\$70.68	25-49	\$65.73	50-99	\$60.78	100 +	\$56.54	 <table border="1"> <thead> <tr> <th colspan="2">PRICE</th> </tr> </thead> <tbody> <tr> <td>1-24</td> <td>\$104.12</td> </tr> <tr> <td>25-49</td> <td>\$96.83</td> </tr> <tr> <td>50-99</td> <td>\$89.54</td> </tr> <tr> <td>100 +</td> <td>\$83.30</td> </tr> </tbody> </table> <p>PRECISION Model No: PE9491 N Male To BNC Female Max VSWR 1.20:1 @ 8 GHz</p>	PRICE		1-24	\$104.12	25-49	\$96.83	50-99	\$89.54	100 +	\$83.30
	PRICE																																											
1-24	\$106.35																																											
25-49	\$98.91																																											
50-99	\$91.46																																											
100 +	\$85.08																																											
PRICE																																												
1-24	\$31.77																																											
25-49	\$29.55																																											
50-99	\$27.32																																											
100 +	\$25.42																																											
PRICE																																												
1-24	\$70.68																																											
25-49	\$65.73																																											
50-99	\$60.78																																											
100 +	\$56.54																																											
PRICE																																												
1-24	\$104.12																																											
25-49	\$96.83																																											
50-99	\$89.54																																											
100 +	\$83.30																																											
6	 <table border="1"> <thead> <tr> <th colspan="2">PRICE</th> </tr> </thead> <tbody> <tr> <td>1-24</td> <td>\$14.21</td> </tr> <tr> <td>25-49</td> <td>\$13.22</td> </tr> <tr> <td>50-99</td> <td>\$12.22</td> </tr> <tr> <td>100 +</td> <td>\$11.37</td> </tr> </tbody> </table> <p>Model No: PE9002 N Male To BNC Female</p>	PRICE		1-24	\$14.21	25-49	\$13.22	50-99	\$12.22	100 +	\$11.37	 <table border="1"> <thead> <tr> <th colspan="2">PRICE</th> </tr> </thead> <tbody> <tr> <td>1-24</td> <td>\$41.14</td> </tr> <tr> <td>25-49</td> <td>\$38.26</td> </tr> <tr> <td>50-99</td> <td>\$35.38</td> </tr> <tr> <td>100 +</td> <td>\$32.91</td> </tr> </tbody> </table> <p>Model No: PE9388 N Male To BNC Female Panel Mount Mounting Hole A05</p>	PRICE		1-24	\$41.14	25-49	\$38.26	50-99	\$35.38	100 +	\$32.91	 <table border="1"> <thead> <tr> <th colspan="2">PRICE</th> </tr> </thead> <tbody> <tr> <td>1-24</td> <td>\$44.74</td> </tr> <tr> <td>25-49</td> <td>\$41.61</td> </tr> <tr> <td>50-99</td> <td>\$38.48</td> </tr> <tr> <td>100 +</td> <td>\$35.79</td> </tr> </tbody> </table> <p>Model No: PE9278 N Male To BNC Female Right Angle</p>	PRICE		1-24	\$44.74	25-49	\$41.61	50-99	\$38.48	100 +	\$35.79	 <table border="1"> <thead> <tr> <th colspan="2">PRICE</th> </tr> </thead> <tbody> <tr> <td>1-24</td> <td>\$104.12</td> </tr> <tr> <td>25-49</td> <td>\$96.83</td> </tr> <tr> <td>50-99</td> <td>\$89.54</td> </tr> <tr> <td>100 +</td> <td>\$83.30</td> </tr> </tbody> </table> <p>PRECISION Model No: PE9490 N Female To BNC Male Max VSWR 1.20:1 @ 8 GHz</p>	PRICE		1-24	\$104.12	25-49	\$96.83	50-99	\$89.54	100 +	\$83.30
	PRICE																																											
1-24	\$14.21																																											
25-49	\$13.22																																											
50-99	\$12.22																																											
100 +	\$11.37																																											
PRICE																																												
1-24	\$41.14																																											
25-49	\$38.26																																											
50-99	\$35.38																																											
100 +	\$32.91																																											
PRICE																																												
1-24	\$44.74																																											
25-49	\$41.61																																											
50-99	\$38.48																																											
100 +	\$35.79																																											
PRICE																																												
1-24	\$104.12																																											
25-49	\$96.83																																											
50-99	\$89.54																																											
100 +	\$83.30																																											

Adapters

See Our Website For Real-Time Stock Availability!













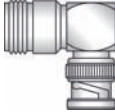
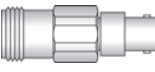

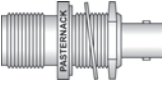



ADAPTERS

See Adapter Locator on Pages 140-145 or the Adapter Matrix on Pages 138-139

See Page 246 for Mounting Holes

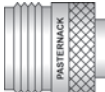
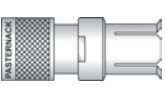
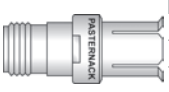
Adapters

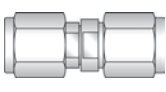
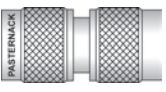











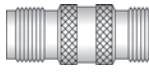
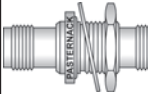
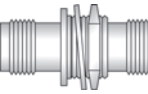

See Our Website For Real-Time Stock Availability!

	A	B	C	D																																								
1	 <table border="1"> <thead> <tr> <th colspan="2">PRICE</th> </tr> </thead> <tbody> <tr> <td>1-24</td> <td>\$12.96</td> </tr> <tr> <td>25-49</td> <td>\$12.05</td> </tr> <tr> <td>50-99</td> <td>\$11.15</td> </tr> <tr> <td>100 +</td> <td>\$10.37</td> </tr> </tbody> </table> <p>Model No: PE9005 N Female To BNC Male</p>	PRICE		1-24	\$12.96	25-49	\$12.05	50-99	\$11.15	100 +	\$10.37	 <table border="1"> <thead> <tr> <th colspan="2">PRICE</th> </tr> </thead> <tbody> <tr> <td>1-24</td> <td>\$58.87</td> </tr> <tr> <td>25-49</td> <td>\$54.75</td> </tr> <tr> <td>50-99</td> <td>\$50.63</td> </tr> <tr> <td>100 +</td> <td>\$47.10</td> </tr> </tbody> </table> <p>Model No: PE9123 N Female To BNC Male Panel Mount Mounting Hole A05</p>	PRICE		1-24	\$58.87	25-49	\$54.75	50-99	\$50.63	100 +	\$47.10	 <table border="1"> <thead> <tr> <th colspan="2">PRICE</th> </tr> </thead> <tbody> <tr> <td>1-24</td> <td>\$47.27</td> </tr> <tr> <td>25-49</td> <td>\$43.96</td> </tr> <tr> <td>50-99</td> <td>\$40.65</td> </tr> <tr> <td>100 +</td> <td>\$37.82</td> </tr> </tbody> </table> <p>Model No: PE9566 N Female To BNC Male Right Angle</p>	PRICE		1-24	\$47.27	25-49	\$43.96	50-99	\$40.65	100 +	\$37.82	 <table border="1"> <thead> <tr> <th colspan="2">PRICE</th> </tr> </thead> <tbody> <tr> <td>1-24</td> <td>\$104.12</td> </tr> <tr> <td>25-49</td> <td>\$96.83</td> </tr> <tr> <td>50-99</td> <td>\$89.54</td> </tr> <tr> <td>100 +</td> <td>\$83.30</td> </tr> </tbody> </table> <p>PRECISION Model No: PE9492 N Female To BNC Female Max VSWR 1.20:1 @ 8 GHz</p>	PRICE		1-24	\$104.12	25-49	\$96.83	50-99	\$89.54	100 +	\$83.30
	PRICE																																											
1-24	\$12.96																																											
25-49	\$12.05																																											
50-99	\$11.15																																											
100 +	\$10.37																																											
PRICE																																												
1-24	\$58.87																																											
25-49	\$54.75																																											
50-99	\$50.63																																											
100 +	\$47.10																																											
PRICE																																												
1-24	\$47.27																																											
25-49	\$43.96																																											
50-99	\$40.65																																											
100 +	\$37.82																																											
PRICE																																												
1-24	\$104.12																																											
25-49	\$96.83																																											
50-99	\$89.54																																											
100 +	\$83.30																																											
2	 <table border="1"> <thead> <tr> <th colspan="2">PRICE</th> </tr> </thead> <tbody> <tr> <td>1-24</td> <td>\$20.32</td> </tr> <tr> <td>25-49</td> <td>\$18.90</td> </tr> <tr> <td>50-99</td> <td>\$17.48</td> </tr> <tr> <td>100 +</td> <td>\$16.26</td> </tr> </tbody> </table> <p>Model No: PE9206 N Female To BNC Female</p>	PRICE		1-24	\$20.32	25-49	\$18.90	50-99	\$17.48	100 +	\$16.26	 <table border="1"> <thead> <tr> <th colspan="2">PRICE</th> </tr> </thead> <tbody> <tr> <td>1-24</td> <td>\$44.74</td> </tr> <tr> <td>25-49</td> <td>\$41.61</td> </tr> <tr> <td>50-99</td> <td>\$38.48</td> </tr> <tr> <td>100 +</td> <td>\$35.79</td> </tr> </tbody> </table> <p>Model No: PE9261 N Female To BNC Female Bulkhead Mounting Hole G01</p>	PRICE		1-24	\$44.74	25-49	\$41.61	50-99	\$38.48	100 +	\$35.79	 <table border="1"> <thead> <tr> <th colspan="2">PRICE</th> </tr> </thead> <tbody> <tr> <td>1-24</td> <td>\$45.90</td> </tr> <tr> <td>25-49</td> <td>\$42.69</td> </tr> <tr> <td>50-99</td> <td>\$39.47</td> </tr> <tr> <td>100 +</td> <td>\$36.72</td> </tr> </tbody> </table> <p>Model No: PE9540 N Female Bulkhead To BNC Female, Mounts From N Female Side Mounting Hole G01</p>	PRICE		1-24	\$45.90	25-49	\$42.69	50-99	\$39.47	100 +	\$36.72	 <table border="1"> <thead> <tr> <th colspan="2">PRICE</th> </tr> </thead> <tbody> <tr> <td>1-24</td> <td>\$32.12</td> </tr> <tr> <td>25-49</td> <td>\$29.87</td> </tr> <tr> <td>50-99</td> <td>\$27.62</td> </tr> <tr> <td>100 +</td> <td>\$25.70</td> </tr> </tbody> </table> <p>Model No: PE9238 N Female To BNC Female Panel Mount Mounting Hole A05</p>	PRICE		1-24	\$32.12	25-49	\$29.87	50-99	\$27.62	100 +	\$25.70
	PRICE																																											
1-24	\$20.32																																											
25-49	\$18.90																																											
50-99	\$17.48																																											
100 +	\$16.26																																											
PRICE																																												
1-24	\$44.74																																											
25-49	\$41.61																																											
50-99	\$38.48																																											
100 +	\$35.79																																											
PRICE																																												
1-24	\$45.90																																											
25-49	\$42.69																																											
50-99	\$39.47																																											
100 +	\$36.72																																											
PRICE																																												
1-24	\$32.12																																											
25-49	\$29.87																																											
50-99	\$27.62																																											
100 +	\$25.70																																											
3	 <table border="1"> <thead> <tr> <th colspan="2">PRICE</th> </tr> </thead> <tbody> <tr> <td>1-24</td> <td>\$47.12</td> </tr> <tr> <td>25-49</td> <td>\$43.82</td> </tr> <tr> <td>50-99</td> <td>\$40.52</td> </tr> <tr> <td>100 +</td> <td>\$37.70</td> </tr> </tbody> </table> <p>Model No: PE9538 N Male To C Male</p>	PRICE		1-24	\$47.12	25-49	\$43.82	50-99	\$40.52	100 +	\$37.70	 <table border="1"> <thead> <tr> <th colspan="2">PRICE</th> </tr> </thead> <tbody> <tr> <td>1-24</td> <td>\$48.33</td> </tr> <tr> <td>25-49</td> <td>\$44.95</td> </tr> <tr> <td>50-99</td> <td>\$41.56</td> </tr> <tr> <td>100 +</td> <td>\$38.66</td> </tr> </tbody> </table> <p>Model No: PE9124 N Male To C Female</p>	PRICE		1-24	\$48.33	25-49	\$44.95	50-99	\$41.56	100 +	\$38.66	 <table border="1"> <thead> <tr> <th colspan="2">PRICE</th> </tr> </thead> <tbody> <tr> <td>1-24</td> <td>\$70.68</td> </tr> <tr> <td>25-49</td> <td>\$65.73</td> </tr> <tr> <td>50-99</td> <td>\$60.78</td> </tr> <tr> <td>100 +</td> <td>\$56.54</td> </tr> </tbody> </table> <p>Model No: PE9239 N Male To C Female Right Angle</p>	PRICE		1-24	\$70.68	25-49	\$65.73	50-99	\$60.78	100 +	\$56.54	 <table border="1"> <thead> <tr> <th colspan="2">PRICE</th> </tr> </thead> <tbody> <tr> <td>1-24</td> <td>\$43.22</td> </tr> <tr> <td>25-49</td> <td>\$40.19</td> </tr> <tr> <td>50-99</td> <td>\$37.17</td> </tr> <tr> <td>100 +</td> <td>\$34.58</td> </tr> </tbody> </table> <p>Model No: PE9295 N Female To C Male</p>	PRICE		1-24	\$43.22	25-49	\$40.19	50-99	\$37.17	100 +	\$34.58
	PRICE																																											
1-24	\$47.12																																											
25-49	\$43.82																																											
50-99	\$40.52																																											
100 +	\$37.70																																											
PRICE																																												
1-24	\$48.33																																											
25-49	\$44.95																																											
50-99	\$41.56																																											
100 +	\$38.66																																											
PRICE																																												
1-24	\$70.68																																											
25-49	\$65.73																																											
50-99	\$60.78																																											
100 +	\$56.54																																											
PRICE																																												
1-24	\$43.22																																											
25-49	\$40.19																																											
50-99	\$37.17																																											
100 +	\$34.58																																											
4	 <table border="1"> <thead> <tr> <th colspan="2">PRICE</th> </tr> </thead> <tbody> <tr> <td>1-24</td> <td>\$47.12</td> </tr> <tr> <td>25-49</td> <td>\$43.82</td> </tr> <tr> <td>50-99</td> <td>\$40.52</td> </tr> <tr> <td>100 +</td> <td>\$37.70</td> </tr> </tbody> </table> <p>Model No: PE9539 N Female To C Female</p>	PRICE		1-24	\$47.12	25-49	\$43.82	50-99	\$40.52	100 +	\$37.70	 <table border="1"> <thead> <tr> <th colspan="2">PRICE</th> </tr> </thead> <tbody> <tr> <td>1-24</td> <td>\$36.58</td> </tr> <tr> <td>25-49</td> <td>\$34.02</td> </tr> <tr> <td>50-99</td> <td>\$31.46</td> </tr> <tr> <td>100 +</td> <td>\$29.26</td> </tr> </tbody> </table> <p>Model No: PE9349 50 Ohm N Male To 75 Ohm N Female</p>	PRICE		1-24	\$36.58	25-49	\$34.02	50-99	\$31.46	100 +	\$29.26	 <table border="1"> <thead> <tr> <th colspan="2">PRICE</th> </tr> </thead> <tbody> <tr> <td>1-24</td> <td>\$31.36</td> </tr> <tr> <td>25-49</td> <td>\$29.16</td> </tr> <tr> <td>50-99</td> <td>\$26.97</td> </tr> <tr> <td>100 +</td> <td>\$25.09</td> </tr> </tbody> </table> <p>Model No: PE9350 50 Ohm N Female To 75 Ohm N Male</p>	PRICE		1-24	\$31.36	25-49	\$29.16	50-99	\$26.97	100 +	\$25.09	 <table border="1"> <thead> <tr> <th colspan="2">PRICE</th> </tr> </thead> <tbody> <tr> <td>1-24</td> <td>\$19.83</td> </tr> <tr> <td>25-49</td> <td>\$18.44</td> </tr> <tr> <td>50-99</td> <td>\$17.05</td> </tr> <tr> <td>100 +</td> <td>\$15.86</td> </tr> </tbody> </table> <p>Model No: PE9155 N Male To F Female</p>	PRICE		1-24	\$19.83	25-49	\$18.44	50-99	\$17.05	100 +	\$15.86
	PRICE																																											
1-24	\$47.12																																											
25-49	\$43.82																																											
50-99	\$40.52																																											
100 +	\$37.70																																											
PRICE																																												
1-24	\$36.58																																											
25-49	\$34.02																																											
50-99	\$31.46																																											
100 +	\$29.26																																											
PRICE																																												
1-24	\$31.36																																											
25-49	\$29.16																																											
50-99	\$26.97																																											
100 +	\$25.09																																											
PRICE																																												
1-24	\$19.83																																											
25-49	\$18.44																																											
50-99	\$17.05																																											
100 +	\$15.86																																											
5	 <table border="1"> <thead> <tr> <th colspan="2">PRICE</th> </tr> </thead> <tbody> <tr> <td>1-24</td> <td>\$27.00</td> </tr> <tr> <td>25-49</td> <td>\$25.11</td> </tr> <tr> <td>50-99</td> <td>\$23.22</td> </tr> <tr> <td>100 +</td> <td>\$21.60</td> </tr> </tbody> </table> <p>Model No: PE9389 N Female To F Male</p>	PRICE		1-24	\$27.00	25-49	\$25.11	50-99	\$23.22	100 +	\$21.60	 <table border="1"> <thead> <tr> <th colspan="2">PRICE</th> </tr> </thead> <tbody> <tr> <td>1-24</td> <td>\$130.36</td> </tr> <tr> <td>25-49</td> <td>\$121.23</td> </tr> <tr> <td>50-99</td> <td>\$112.11</td> </tr> <tr> <td>100 +</td> <td>\$104.29</td> </tr> </tbody> </table> <p>Model No: PE9257 N Male To GR874</p>	PRICE		1-24	\$130.36	25-49	\$121.23	50-99	\$112.11	100 +	\$104.29	 <table border="1"> <thead> <tr> <th colspan="2">PRICE</th> </tr> </thead> <tbody> <tr> <td>1-24</td> <td>\$130.36</td> </tr> <tr> <td>25-49</td> <td>\$121.23</td> </tr> <tr> <td>50-99</td> <td>\$112.11</td> </tr> <tr> <td>100 +</td> <td>\$104.29</td> </tr> </tbody> </table> <p>Model No: PE9258 N Female To GR874</p>	PRICE		1-24	\$130.36	25-49	\$121.23	50-99	\$112.11	100 +	\$104.29	<div style="background-color: black; color: white; padding: 20px; text-align: center;"> <h2>TNC In-Series</h2>  </div>										
	PRICE																																											
1-24	\$27.00																																											
25-49	\$25.11																																											
50-99	\$23.22																																											
100 +	\$21.60																																											
PRICE																																												
1-24	\$130.36																																											
25-49	\$121.23																																											
50-99	\$112.11																																											
100 +	\$104.29																																											
PRICE																																												
1-24	\$130.36																																											
25-49	\$121.23																																											
50-99	\$112.11																																											
100 +	\$104.29																																											
6	 <table border="1"> <thead> <tr> <th colspan="2">PRICE</th> </tr> </thead> <tbody> <tr> <td>1-24</td> <td>\$94.08</td> </tr> <tr> <td>25-49</td> <td>\$87.49</td> </tr> <tr> <td>50-99</td> <td>\$80.91</td> </tr> <tr> <td>100 +</td> <td>\$75.26</td> </tr> </tbody> </table> <p>PRECISION Model No: PE9445 TNC Male To TNC Male Max VSWR 1.25:1 @ 18 GHz</p>	PRICE		1-24	\$94.08	25-49	\$87.49	50-99	\$80.91	100 +	\$75.26	 <table border="1"> <thead> <tr> <th colspan="2">PRICE</th> </tr> </thead> <tbody> <tr> <td>1-24</td> <td>\$18.24</td> </tr> <tr> <td>25-49</td> <td>\$16.96</td> </tr> <tr> <td>50-99</td> <td>\$15.69</td> </tr> <tr> <td>100 +</td> <td>\$14.59</td> </tr> </tbody> </table> <p>Model No: PE9091 TNC Male To TNC Male</p>	PRICE		1-24	\$18.24	25-49	\$16.96	50-99	\$15.69	100 +	\$14.59	 <table border="1"> <thead> <tr> <th colspan="2">PRICE</th> </tr> </thead> <tbody> <tr> <td>1-24</td> <td>\$49.30</td> </tr> <tr> <td>25-49</td> <td>\$45.85</td> </tr> <tr> <td>50-99</td> <td>\$42.40</td> </tr> <tr> <td>100 +</td> <td>\$39.44</td> </tr> </tbody> </table> <p>Model No: PE9560 TNC Male To TNC Male Right Angle</p>	PRICE		1-24	\$49.30	25-49	\$45.85	50-99	\$42.40	100 +	\$39.44	 <table border="1"> <thead> <tr> <th colspan="2">PRICE</th> </tr> </thead> <tbody> <tr> <td>1-24</td> <td>\$94.08</td> </tr> <tr> <td>25-49</td> <td>\$87.49</td> </tr> <tr> <td>50-99</td> <td>\$80.91</td> </tr> <tr> <td>100 +</td> <td>\$75.26</td> </tr> </tbody> </table> <p>PRECISION Model No: PE9443 TNC Male To TNC Female Max VSWR 1.25:1 @ 18 GHz</p>	PRICE		1-24	\$94.08	25-49	\$87.49	50-99	\$80.91	100 +	\$75.26
	PRICE																																											
1-24	\$94.08																																											
25-49	\$87.49																																											
50-99	\$80.91																																											
100 +	\$75.26																																											
PRICE																																												
1-24	\$18.24																																											
25-49	\$16.96																																											
50-99	\$15.69																																											
100 +	\$14.59																																											
PRICE																																												
1-24	\$49.30																																											
25-49	\$45.85																																											
50-99	\$42.40																																											
100 +	\$39.44																																											
PRICE																																												
1-24	\$94.08																																											
25-49	\$87.49																																											
50-99	\$80.91																																											
100 +	\$75.26																																											

ADAPTERS

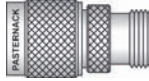
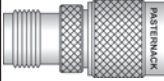
See Adapter Locator on Pages 140-145 or the Adapter Matrix on Pages 138-139

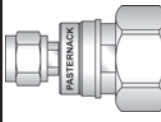
See Page 246 for Mounting Holes

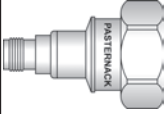
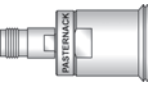
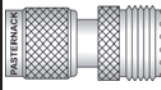
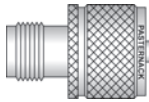
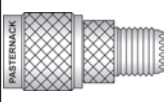
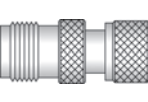
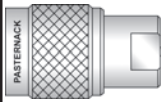
	A	B	C	D																																								
1	 <table border="1"> <thead> <tr> <th colspan="2">PRICE</th> </tr> </thead> <tbody> <tr> <td>1-24</td> <td>\$141.15</td> </tr> <tr> <td>25-49</td> <td>\$131.27</td> </tr> <tr> <td>50-99</td> <td>\$121.39</td> </tr> <tr> <td>100 +</td> <td>\$112.92</td> </tr> </tbody> </table> <p>Model No: PE9561 TNC Male Quick Disconnect To TNC Female</p>	PRICE		1-24	\$141.15	25-49	\$131.27	50-99	\$121.39	100 +	\$112.92	 <table border="1"> <thead> <tr> <th colspan="2">PRICE</th> </tr> </thead> <tbody> <tr> <td>1-24</td> <td>\$33.78</td> </tr> <tr> <td>25-49</td> <td>\$31.42</td> </tr> <tr> <td>50-99</td> <td>\$29.05</td> </tr> <tr> <td>100 +</td> <td>\$27.02</td> </tr> </tbody> </table> <p>Model No: PE9100 TNC Male To TNC Female Right Angle</p>	PRICE		1-24	\$33.78	25-49	\$31.42	50-99	\$29.05	100 +	\$27.02	 <table border="1"> <thead> <tr> <th colspan="2">PRICE</th> </tr> </thead> <tbody> <tr> <td>1-24</td> <td>\$15.86</td> </tr> <tr> <td>25-49</td> <td>\$14.75</td> </tr> <tr> <td>50-99</td> <td>\$13.64</td> </tr> <tr> <td>100 +</td> <td>\$12.69</td> </tr> </tbody> </table> <p>Model No: PE9270 TNC Male To TNC Female</p>	PRICE		1-24	\$15.86	25-49	\$14.75	50-99	\$13.64	100 +	\$12.69	 <table border="1"> <thead> <tr> <th colspan="2">PRICE</th> </tr> </thead> <tbody> <tr> <td>1-24</td> <td>\$92.56</td> </tr> <tr> <td>25-49</td> <td>\$86.08</td> </tr> <tr> <td>50-99</td> <td>\$79.60</td> </tr> <tr> <td>100 +</td> <td>\$74.05</td> </tr> </tbody> </table> <p>PRECISION Model No: PE9444 TNC Female To TNC Female Max VSWR 1.25:1 @ 18 GHz</p>	PRICE		1-24	\$92.56	25-49	\$86.08	50-99	\$79.60	100 +	\$74.05
	PRICE																																											
1-24	\$141.15																																											
25-49	\$131.27																																											
50-99	\$121.39																																											
100 +	\$112.92																																											
PRICE																																												
1-24	\$33.78																																											
25-49	\$31.42																																											
50-99	\$29.05																																											
100 +	\$27.02																																											
PRICE																																												
1-24	\$15.86																																											
25-49	\$14.75																																											
50-99	\$13.64																																											
100 +	\$12.69																																											
PRICE																																												
1-24	\$92.56																																											
25-49	\$86.08																																											
50-99	\$79.60																																											
100 +	\$74.05																																											
2	 <table border="1"> <thead> <tr> <th colspan="2">PRICE</th> </tr> </thead> <tbody> <tr> <td>1-24</td> <td>\$19.41</td> </tr> <tr> <td>25-49</td> <td>\$18.05</td> </tr> <tr> <td>50-99</td> <td>\$16.69</td> </tr> <tr> <td>100 +</td> <td>\$15.53</td> </tr> </tbody> </table> <p>Model No: PE9099 TNC Female To TNC Female</p>	PRICE		1-24	\$19.41	25-49	\$18.05	50-99	\$16.69	100 +	\$15.53	 <table border="1"> <thead> <tr> <th colspan="2">PRICE</th> </tr> </thead> <tbody> <tr> <td>1-24</td> <td>\$18.24</td> </tr> <tr> <td>25-49</td> <td>\$16.96</td> </tr> <tr> <td>50-99</td> <td>\$15.69</td> </tr> <tr> <td>100 +</td> <td>\$14.59</td> </tr> </tbody> </table> <p>Model No: PE9154 TNC Female To TNC Female Bulkhead, Hermetically Sealed Mounting Hole B06</p>	PRICE		1-24	\$18.24	25-49	\$16.96	50-99	\$15.69	100 +	\$14.59	 <table border="1"> <thead> <tr> <th colspan="2">PRICE</th> </tr> </thead> <tbody> <tr> <td>1-24</td> <td>\$20.52</td> </tr> <tr> <td>25-49</td> <td>\$19.08</td> </tr> <tr> <td>50-99</td> <td>\$17.65</td> </tr> <tr> <td>100 +</td> <td>\$16.42</td> </tr> </tbody> </table> <p>Model No: PE9287 TNC Female To TNC Female Bulkhead, Isolated Ground Mounting Hole B06</p>	PRICE		1-24	\$20.52	25-49	\$19.08	50-99	\$17.65	100 +	\$16.42	 <table border="1"> <thead> <tr> <th colspan="2">PRICE</th> </tr> </thead> <tbody> <tr> <td>1-24</td> <td>\$12.06</td> </tr> <tr> <td>25-49</td> <td>\$11.22</td> </tr> <tr> <td>50-99</td> <td>\$10.37</td> </tr> <tr> <td>100 +</td> <td>\$9.65</td> </tr> </tbody> </table> <p>Model No: PE9288 TNC Female To TNC Female Panel Mount Mounting Hole A03</p>	PRICE		1-24	\$12.06	25-49	\$11.22	50-99	\$10.37	100 +	\$9.65
	PRICE																																											
1-24	\$19.41																																											
25-49	\$18.05																																											
50-99	\$16.69																																											
100 +	\$15.53																																											
PRICE																																												
1-24	\$18.24																																											
25-49	\$16.96																																											
50-99	\$15.69																																											
100 +	\$14.59																																											
PRICE																																												
1-24	\$20.52																																											
25-49	\$19.08																																											
50-99	\$17.65																																											
100 +	\$16.42																																											
PRICE																																												
1-24	\$12.06																																											
25-49	\$11.22																																											
50-99	\$10.37																																											
100 +	\$9.65																																											
3	 <table border="1"> <thead> <tr> <th colspan="2">PRICE</th> </tr> </thead> <tbody> <tr> <td>1-24</td> <td>\$16.87</td> </tr> <tr> <td>25-49</td> <td>\$15.69</td> </tr> <tr> <td>50-99</td> <td>\$14.51</td> </tr> <tr> <td>100 +</td> <td>\$13.50</td> </tr> </tbody> </table> <p>Model No: PE9195 TNC "T" Female-Male-Female</p>	PRICE		1-24	\$16.87	25-49	\$15.69	50-99	\$14.51	100 +	\$13.50	 <table border="1"> <thead> <tr> <th colspan="2">PRICE</th> </tr> </thead> <tbody> <tr> <td>1-24</td> <td>\$41.14</td> </tr> <tr> <td>25-49</td> <td>\$38.26</td> </tr> <tr> <td>50-99</td> <td>\$35.38</td> </tr> <tr> <td>100 +</td> <td>\$32.91</td> </tr> </tbody> </table> <p>Model No: PE9290 TNC "T" Male-Female-Female</p>	PRICE		1-24	\$41.14	25-49	\$38.26	50-99	\$35.38	100 +	\$32.91	 <table border="1"> <thead> <tr> <th colspan="2">PRICE</th> </tr> </thead> <tbody> <tr> <td>1-24</td> <td>\$23.36</td> </tr> <tr> <td>25-49</td> <td>\$21.72</td> </tr> <tr> <td>50-99</td> <td>\$20.09</td> </tr> <tr> <td>100 +</td> <td>\$18.69</td> </tr> </tbody> </table> <p>Model No: PE9289 TNC "T" Female-Female-Female</p>	PRICE		1-24	\$23.36	25-49	\$21.72	50-99	\$20.09	100 +	\$18.69	 <table border="1"> <thead> <tr> <th colspan="2">PRICE</th> </tr> </thead> <tbody> <tr> <td>1-24</td> <td>\$18.75</td> </tr> <tr> <td>25-49</td> <td>\$17.44</td> </tr> <tr> <td>50-99</td> <td>\$16.13</td> </tr> <tr> <td>100 +</td> <td>\$15.00</td> </tr> </tbody> </table> <p>PRECISION Model No: PE9918 Reverse Polarity TNC Male To Reverse Polarity TNC Female, Right Angle Max VSWR 1.25:1 @ 11 GHz</p>	PRICE		1-24	\$18.75	25-49	\$17.44	50-99	\$16.13	100 +	\$15.00
	PRICE																																											
1-24	\$16.87																																											
25-49	\$15.69																																											
50-99	\$14.51																																											
100 +	\$13.50																																											
PRICE																																												
1-24	\$41.14																																											
25-49	\$38.26																																											
50-99	\$35.38																																											
100 +	\$32.91																																											
PRICE																																												
1-24	\$23.36																																											
25-49	\$21.72																																											
50-99	\$20.09																																											
100 +	\$18.69																																											
PRICE																																												
1-24	\$18.75																																											
25-49	\$17.44																																											
50-99	\$16.13																																											
100 +	\$15.00																																											
4	 <table border="1"> <thead> <tr> <th colspan="2">PRICE</th> </tr> </thead> <tbody> <tr> <td>1-24</td> <td>\$28.93</td> </tr> <tr> <td>25-49</td> <td>\$26.90</td> </tr> <tr> <td>50-99</td> <td>\$24.88</td> </tr> <tr> <td>100 +</td> <td>\$23.14</td> </tr> </tbody> </table> <p>Model No: PE9532 Standard TNC Male To Reverse Polarity TNC Female</p>	PRICE		1-24	\$28.93	25-49	\$26.90	50-99	\$24.88	100 +	\$23.14	 <table border="1"> <thead> <tr> <th colspan="2">PRICE</th> </tr> </thead> <tbody> <tr> <td>1-24</td> <td>\$29.39</td> </tr> <tr> <td>25-49</td> <td>\$27.33</td> </tr> <tr> <td>50-99</td> <td>\$25.28</td> </tr> <tr> <td>100 +</td> <td>\$23.51</td> </tr> </tbody> </table> <p>Model No: PE9531 Standard TNC Female To Reverse Polarity TNC Male</p>	PRICE		1-24	\$29.39	25-49	\$27.33	50-99	\$25.28	100 +	\$23.51	<p>TNC Between-Series</p> 		 <table border="1"> <thead> <tr> <th colspan="2">PRICE</th> </tr> </thead> <tbody> <tr> <td>1-24</td> <td>\$200.13</td> </tr> <tr> <td>25-49</td> <td>\$186.12</td> </tr> <tr> <td>50-99</td> <td>\$172.11</td> </tr> <tr> <td>100 +</td> <td>\$160.10</td> </tr> </tbody> </table> <p>Model No: PE9637 TNC Male To 7/16 Male</p>	PRICE		1-24	\$200.13	25-49	\$186.12	50-99	\$172.11	100 +	\$160.10									
	PRICE																																											
1-24	\$28.93																																											
25-49	\$26.90																																											
50-99	\$24.88																																											
100 +	\$23.14																																											
PRICE																																												
1-24	\$29.39																																											
25-49	\$27.33																																											
50-99	\$25.28																																											
100 +	\$23.51																																											
PRICE																																												
1-24	\$200.13																																											
25-49	\$186.12																																											
50-99	\$172.11																																											
100 +	\$160.10																																											
5	 <table border="1"> <thead> <tr> <th colspan="2">PRICE</th> </tr> </thead> <tbody> <tr> <td>1-24</td> <td>\$188.37</td> </tr> <tr> <td>25-49</td> <td>\$175.18</td> </tr> <tr> <td>50-99</td> <td>\$162.00</td> </tr> <tr> <td>100 +</td> <td>\$150.70</td> </tr> </tbody> </table> <p>Model No: PE9638 TNC Male To 7/16 Female</p>	PRICE		1-24	\$188.37	25-49	\$175.18	50-99	\$162.00	100 +	\$150.70	 <table border="1"> <thead> <tr> <th colspan="2">PRICE</th> </tr> </thead> <tbody> <tr> <td>1-24</td> <td>\$200.13</td> </tr> <tr> <td>25-49</td> <td>\$186.12</td> </tr> <tr> <td>50-99</td> <td>\$172.11</td> </tr> <tr> <td>100 +</td> <td>\$160.10</td> </tr> </tbody> </table> <p>Model No: PE9636 TNC Female To 7/16 Male</p>	PRICE		1-24	\$200.13	25-49	\$186.12	50-99	\$172.11	100 +	\$160.10	 <table border="1"> <thead> <tr> <th colspan="2">PRICE</th> </tr> </thead> <tbody> <tr> <td>1-24</td> <td>\$200.13</td> </tr> <tr> <td>25-49</td> <td>\$186.12</td> </tr> <tr> <td>50-99</td> <td>\$172.11</td> </tr> <tr> <td>100 +</td> <td>\$160.10</td> </tr> </tbody> </table> <p>Model No: PE9639 TNC Female To 7/16 Female</p>	PRICE		1-24	\$200.13	25-49	\$186.12	50-99	\$172.11	100 +	\$160.10	 <table border="1"> <thead> <tr> <th colspan="2">PRICE</th> </tr> </thead> <tbody> <tr> <td>1-24</td> <td>\$14.69</td> </tr> <tr> <td>25-49</td> <td>\$13.66</td> </tr> <tr> <td>50-99</td> <td>\$12.63</td> </tr> <tr> <td>100 +</td> <td>\$11.75</td> </tr> </tbody> </table> <p>Model No: PE9291 TNC Male To UHF Female</p>	PRICE		1-24	\$14.69	25-49	\$13.66	50-99	\$12.63	100 +	\$11.75
	PRICE																																											
1-24	\$188.37																																											
25-49	\$175.18																																											
50-99	\$162.00																																											
100 +	\$150.70																																											
PRICE																																												
1-24	\$200.13																																											
25-49	\$186.12																																											
50-99	\$172.11																																											
100 +	\$160.10																																											
PRICE																																												
1-24	\$200.13																																											
25-49	\$186.12																																											
50-99	\$172.11																																											
100 +	\$160.10																																											
PRICE																																												
1-24	\$14.69																																											
25-49	\$13.66																																											
50-99	\$12.63																																											
100 +	\$11.75																																											
6	 <table border="1"> <thead> <tr> <th colspan="2">PRICE</th> </tr> </thead> <tbody> <tr> <td>1-24</td> <td>\$15.91</td> </tr> <tr> <td>25-49</td> <td>\$14.80</td> </tr> <tr> <td>50-99</td> <td>\$13.68</td> </tr> <tr> <td>100 +</td> <td>\$12.73</td> </tr> </tbody> </table> <p>Model No: PE9372 TNC Female To UHF Male</p>	PRICE		1-24	\$15.91	25-49	\$14.80	50-99	\$13.68	100 +	\$12.73	 <table border="1"> <thead> <tr> <th colspan="2">PRICE</th> </tr> </thead> <tbody> <tr> <td>1-24</td> <td>\$10.99</td> </tr> <tr> <td>25-49</td> <td>\$10.22</td> </tr> <tr> <td>50-99</td> <td>\$9.45</td> </tr> <tr> <td>100 +</td> <td>\$8.79</td> </tr> </tbody> </table> <p>Model No: PE9345 TNC Male To Mini-UHF Female</p>	PRICE		1-24	\$10.99	25-49	\$10.22	50-99	\$9.45	100 +	\$8.79	 <table border="1"> <thead> <tr> <th colspan="2">PRICE</th> </tr> </thead> <tbody> <tr> <td>1-24</td> <td>\$10.99</td> </tr> <tr> <td>25-49</td> <td>\$10.22</td> </tr> <tr> <td>50-99</td> <td>\$9.45</td> </tr> <tr> <td>100 +</td> <td>\$8.79</td> </tr> </tbody> </table> <p>Model No: PE9346 TNC Female To Mini-UHF Male</p>	PRICE		1-24	\$10.99	25-49	\$10.22	50-99	\$9.45	100 +	\$8.79	 <table border="1"> <thead> <tr> <th colspan="2">PRICE</th> </tr> </thead> <tbody> <tr> <td>1-24</td> <td>\$11.70</td> </tr> <tr> <td>25-49</td> <td>\$10.88</td> </tr> <tr> <td>50-99</td> <td>\$10.06</td> </tr> <tr> <td>100 +</td> <td>\$9.36</td> </tr> </tbody> </table> <p>Model No: PE9699 TNC Male To FME Plug</p>	PRICE		1-24	\$11.70	25-49	\$10.88	50-99	\$10.06	100 +	\$9.36
	PRICE																																											
1-24	\$15.91																																											
25-49	\$14.80																																											
50-99	\$13.68																																											
100 +	\$12.73																																											
PRICE																																												
1-24	\$10.99																																											
25-49	\$10.22																																											
50-99	\$9.45																																											
100 +	\$8.79																																											
PRICE																																												
1-24	\$10.99																																											
25-49	\$10.22																																											
50-99	\$9.45																																											
100 +	\$8.79																																											
PRICE																																												
1-24	\$11.70																																											
25-49	\$10.88																																											
50-99	\$10.06																																											
100 +	\$9.36																																											

Adapters

See Our Website For Real-Time Stock Availability!











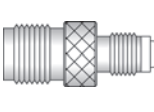
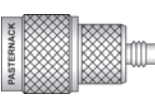
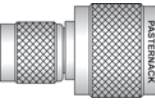
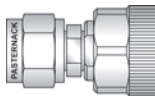
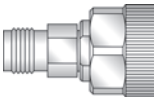

ADAPTERS

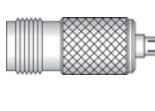
See Adapter Locator on Pages 140-145 or the Adapter Matrix on Pages 138-139

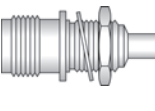
See Page 246 for Mounting Holes

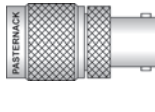
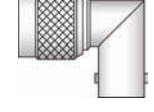
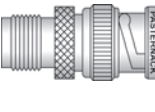
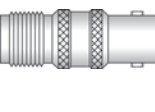
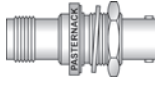
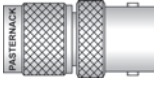
Adapters

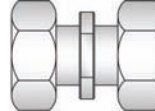

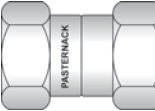







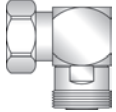

See Our Website For Real-Time Stock Availability!

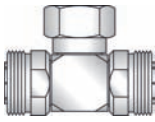
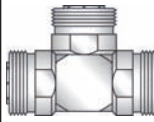
	A	B	C	D																																								
1	 <table border="1"> <thead> <tr> <th colspan="2">PRICE</th> </tr> </thead> <tbody> <tr> <td>1-24</td> <td>\$11.70</td> </tr> <tr> <td>25-49</td> <td>\$10.88</td> </tr> <tr> <td>50-99</td> <td>\$10.06</td> </tr> <tr> <td>100 +</td> <td>\$9.36</td> </tr> </tbody> </table> <p>Model No: PE9700 TNC Male To FME Plug Right Angle</p>	PRICE		1-24	\$11.70	25-49	\$10.88	50-99	\$10.06	100 +	\$9.36	 <table border="1"> <thead> <tr> <th colspan="2">PRICE</th> </tr> </thead> <tbody> <tr> <td>1-24</td> <td>\$11.70</td> </tr> <tr> <td>25-49</td> <td>\$10.88</td> </tr> <tr> <td>50-99</td> <td>\$10.06</td> </tr> <tr> <td>100 +</td> <td>\$9.36</td> </tr> </tbody> </table> <p>Model No: PE9713 TNC Male To FME Jack</p>	PRICE		1-24	\$11.70	25-49	\$10.88	50-99	\$10.06	100 +	\$9.36	 <table border="1"> <thead> <tr> <th colspan="2">PRICE</th> </tr> </thead> <tbody> <tr> <td>1-24</td> <td>\$11.70</td> </tr> <tr> <td>25-49</td> <td>\$10.88</td> </tr> <tr> <td>50-99</td> <td>\$10.06</td> </tr> <tr> <td>100 +</td> <td>\$9.36</td> </tr> </tbody> </table> <p>Model No: PE9714 TNC Female To FME Jack</p>	PRICE		1-24	\$11.70	25-49	\$10.88	50-99	\$10.06	100 +	\$9.36	 <table border="1"> <thead> <tr> <th colspan="2">PRICE</th> </tr> </thead> <tbody> <tr> <td>1-24</td> <td>\$42.96</td> </tr> <tr> <td>25-49</td> <td>\$39.95</td> </tr> <tr> <td>50-99</td> <td>\$36.95</td> </tr> <tr> <td>100 +</td> <td>\$34.37</td> </tr> </tbody> </table> <p>Model No: PE9226 TNC Male To SMC Jack</p>	PRICE		1-24	\$42.96	25-49	\$39.95	50-99	\$36.95	100 +	\$34.37
PRICE																																												
1-24	\$11.70																																											
25-49	\$10.88																																											
50-99	\$10.06																																											
100 +	\$9.36																																											
PRICE																																												
1-24	\$11.70																																											
25-49	\$10.88																																											
50-99	\$10.06																																											
100 +	\$9.36																																											
PRICE																																												
1-24	\$11.70																																											
25-49	\$10.88																																											
50-99	\$10.06																																											
100 +	\$9.36																																											
PRICE																																												
1-24	\$42.96																																											
25-49	\$39.95																																											
50-99	\$36.95																																											
100 +	\$34.37																																											
2	 <table border="1"> <thead> <tr> <th colspan="2">PRICE</th> </tr> </thead> <tbody> <tr> <td>1-24</td> <td>\$59.02</td> </tr> <tr> <td>25-49</td> <td>\$54.89</td> </tr> <tr> <td>50-99</td> <td>\$50.76</td> </tr> <tr> <td>100 +</td> <td>\$47.22</td> </tr> </tbody> </table> <p>Model No: PE9563 TNC Male To HN Male</p>	PRICE		1-24	\$59.02	25-49	\$54.89	50-99	\$50.76	100 +	\$47.22	 <table border="1"> <thead> <tr> <th colspan="2">PRICE</th> </tr> </thead> <tbody> <tr> <td>1-24</td> <td>\$235.44</td> </tr> <tr> <td>25-49</td> <td>\$218.96</td> </tr> <tr> <td>50-99</td> <td>\$202.48</td> </tr> <tr> <td>100 +</td> <td>\$188.35</td> </tr> </tbody> </table> <p>PRECISION Model No: PE9219 TNC Male To 7mm Max VSWR 1.15:1 @ 18 GHz</p>	PRICE		1-24	\$235.44	25-49	\$218.96	50-99	\$202.48	100 +	\$188.35	 <table border="1"> <thead> <tr> <th colspan="2">PRICE</th> </tr> </thead> <tbody> <tr> <td>1-24</td> <td>\$235.44</td> </tr> <tr> <td>25-49</td> <td>\$218.96</td> </tr> <tr> <td>50-99</td> <td>\$202.48</td> </tr> <tr> <td>100 +</td> <td>\$188.35</td> </tr> </tbody> </table> <p>PRECISION Model No: PE9218 TNC Female To 7mm Max VSWR 1.15:1 @ 18 GHz</p>	PRICE		1-24	\$235.44	25-49	\$218.96	50-99	\$202.48	100 +	\$188.35	 <table border="1"> <thead> <tr> <th colspan="2">PRICE</th> </tr> </thead> <tbody> <tr> <td>1-24</td> <td>\$58.87</td> </tr> <tr> <td>25-49</td> <td>\$54.75</td> </tr> <tr> <td>50-99</td> <td>\$50.63</td> </tr> <tr> <td>100 +</td> <td>\$47.10</td> </tr> </tbody> </table> <p>Model No: PE9543 TNC Male To MCX Plug</p>	PRICE		1-24	\$58.87	25-49	\$54.75	50-99	\$50.63	100 +	\$47.10
PRICE																																												
1-24	\$59.02																																											
25-49	\$54.89																																											
50-99	\$50.76																																											
100 +	\$47.22																																											
PRICE																																												
1-24	\$235.44																																											
25-49	\$218.96																																											
50-99	\$202.48																																											
100 +	\$188.35																																											
PRICE																																												
1-24	\$235.44																																											
25-49	\$218.96																																											
50-99	\$202.48																																											
100 +	\$188.35																																											
PRICE																																												
1-24	\$58.87																																											
25-49	\$54.75																																											
50-99	\$50.63																																											
100 +	\$47.10																																											
3	 <table border="1"> <thead> <tr> <th colspan="2">PRICE</th> </tr> </thead> <tbody> <tr> <td>1-24</td> <td>\$51.32</td> </tr> <tr> <td>25-49</td> <td>\$47.73</td> </tr> <tr> <td>50-99</td> <td>\$44.14</td> </tr> <tr> <td>100 +</td> <td>\$41.06</td> </tr> </tbody> </table> <p>Model No: PE9542 TNC Male To MCX Jack</p>	PRICE		1-24	\$51.32	25-49	\$47.73	50-99	\$44.14	100 +	\$41.06	 <table border="1"> <thead> <tr> <th colspan="2">PRICE</th> </tr> </thead> <tbody> <tr> <td>1-24</td> <td>\$58.87</td> </tr> <tr> <td>25-49</td> <td>\$54.75</td> </tr> <tr> <td>50-99</td> <td>\$50.63</td> </tr> <tr> <td>100 +</td> <td>\$47.10</td> </tr> </tbody> </table> <p>Model No: PE9545 TNC Female To MCX Plug</p>	PRICE		1-24	\$58.87	25-49	\$54.75	50-99	\$50.63	100 +	\$47.10	 <table border="1"> <thead> <tr> <th colspan="2">PRICE</th> </tr> </thead> <tbody> <tr> <td>1-24</td> <td>\$58.87</td> </tr> <tr> <td>25-49</td> <td>\$54.75</td> </tr> <tr> <td>50-99</td> <td>\$50.63</td> </tr> <tr> <td>100 +</td> <td>\$47.10</td> </tr> </tbody> </table> <p>Model No: PE9544 TNC Female To MCX Jack</p>	PRICE		1-24	\$58.87	25-49	\$54.75	50-99	\$50.63	100 +	\$47.10	 <table border="1"> <thead> <tr> <th colspan="2">PRICE</th> </tr> </thead> <tbody> <tr> <td>1-24</td> <td>\$67.03</td> </tr> <tr> <td>25-49</td> <td>\$62.34</td> </tr> <tr> <td>50-99</td> <td>\$57.65</td> </tr> <tr> <td>100 +</td> <td>\$53.62</td> </tr> </tbody> </table> <p>Model No: PE9521 TNC Female To MCX Jack Bulkhead Mounting Hole B04</p>	PRICE		1-24	\$67.03	25-49	\$62.34	50-99	\$57.65	100 +	\$53.62
PRICE																																												
1-24	\$51.32																																											
25-49	\$47.73																																											
50-99	\$44.14																																											
100 +	\$41.06																																											
PRICE																																												
1-24	\$58.87																																											
25-49	\$54.75																																											
50-99	\$50.63																																											
100 +	\$47.10																																											
PRICE																																												
1-24	\$58.87																																											
25-49	\$54.75																																											
50-99	\$50.63																																											
100 +	\$47.10																																											
PRICE																																												
1-24	\$67.03																																											
25-49	\$62.34																																											
50-99	\$57.65																																											
100 +	\$53.62																																											
4	 <table border="1"> <thead> <tr> <th colspan="2">PRICE</th> </tr> </thead> <tbody> <tr> <td>1-24</td> <td>\$21.68</td> </tr> <tr> <td>25-49</td> <td>\$20.16</td> </tr> <tr> <td>50-99</td> <td>\$18.64</td> </tr> <tr> <td>100 +</td> <td>\$17.34</td> </tr> </tbody> </table> <p>Model No: PE9110 TNC Male To BNC Male</p>	PRICE		1-24	\$21.68	25-49	\$20.16	50-99	\$18.64	100 +	\$17.34	 <table border="1"> <thead> <tr> <th colspan="2">PRICE</th> </tr> </thead> <tbody> <tr> <td>1-24</td> <td>\$20.09</td> </tr> <tr> <td>25-49</td> <td>\$18.68</td> </tr> <tr> <td>50-99</td> <td>\$17.28</td> </tr> <tr> <td>100 +</td> <td>\$16.07</td> </tr> </tbody> </table> <p>Model No: PE9088 TNC Male To BNC Female</p>	PRICE		1-24	\$20.09	25-49	\$18.68	50-99	\$17.28	100 +	\$16.07	 <table border="1"> <thead> <tr> <th colspan="2">PRICE</th> </tr> </thead> <tbody> <tr> <td>1-24</td> <td>\$48.08</td> </tr> <tr> <td>25-49</td> <td>\$44.71</td> </tr> <tr> <td>50-99</td> <td>\$41.35</td> </tr> <tr> <td>100 +</td> <td>\$38.46</td> </tr> </tbody> </table> <p>Model No: PE9783 TNC Male To BNC Female Right Angle</p>	PRICE		1-24	\$48.08	25-49	\$44.71	50-99	\$41.35	100 +	\$38.46	 <table border="1"> <thead> <tr> <th colspan="2">PRICE</th> </tr> </thead> <tbody> <tr> <td>1-24</td> <td>\$21.45</td> </tr> <tr> <td>25-49</td> <td>\$19.95</td> </tr> <tr> <td>50-99</td> <td>\$18.45</td> </tr> <tr> <td>100 +</td> <td>\$17.16</td> </tr> </tbody> </table> <p>Model No: PE9098 TNC Female To BNC Male</p>	PRICE		1-24	\$21.45	25-49	\$19.95	50-99	\$18.45	100 +	\$17.16
PRICE																																												
1-24	\$21.68																																											
25-49	\$20.16																																											
50-99	\$18.64																																											
100 +	\$17.34																																											
PRICE																																												
1-24	\$20.09																																											
25-49	\$18.68																																											
50-99	\$17.28																																											
100 +	\$16.07																																											
PRICE																																												
1-24	\$48.08																																											
25-49	\$44.71																																											
50-99	\$41.35																																											
100 +	\$38.46																																											
PRICE																																												
1-24	\$21.45																																											
25-49	\$19.95																																											
50-99	\$18.45																																											
100 +	\$17.16																																											
5	 <table border="1"> <thead> <tr> <th colspan="2">PRICE</th> </tr> </thead> <tbody> <tr> <td>1-24</td> <td>\$18.10</td> </tr> <tr> <td>25-49</td> <td>\$16.83</td> </tr> <tr> <td>50-99</td> <td>\$15.57</td> </tr> <tr> <td>100 +</td> <td>\$14.48</td> </tr> </tbody> </table> <p>Model No: PE9097 TNC Female To BNC Female</p>	PRICE		1-24	\$18.10	25-49	\$16.83	50-99	\$15.57	100 +	\$14.48	 <table border="1"> <thead> <tr> <th colspan="2">PRICE</th> </tr> </thead> <tbody> <tr> <td>1-24</td> <td>\$33.49</td> </tr> <tr> <td>25-49</td> <td>\$31.15</td> </tr> <tr> <td>50-99</td> <td>\$28.80</td> </tr> <tr> <td>100 +</td> <td>\$26.79</td> </tr> </tbody> </table> <p>Model No: PE9483 TNC Female To BNC Female Bulkhead, Hermetically Sealed Mounting Hole B06</p>	PRICE		1-24	\$33.49	25-49	\$31.15	50-99	\$28.80	100 +	\$26.79	 <table border="1"> <thead> <tr> <th colspan="2">PRICE</th> </tr> </thead> <tbody> <tr> <td>1-24</td> <td>\$59.02</td> </tr> <tr> <td>25-49</td> <td>\$54.89</td> </tr> <tr> <td>50-99</td> <td>\$50.76</td> </tr> <tr> <td>100 +</td> <td>\$47.22</td> </tr> </tbody> </table> <p>Model No: PE9562 TNC Male To C Female</p>	PRICE		1-24	\$59.02	25-49	\$54.89	50-99	\$50.76	100 +	\$47.22	 <table border="1"> <thead> <tr> <th colspan="2">PRICE</th> </tr> </thead> <tbody> <tr> <td>1-24</td> <td>\$79.70</td> </tr> <tr> <td>25-49</td> <td>\$74.12</td> </tr> <tr> <td>50-99</td> <td>\$68.54</td> </tr> <tr> <td>100 +</td> <td>\$63.76</td> </tr> </tbody> </table> <p>Model No: PE9564 TNC Female To C Male</p>	PRICE		1-24	\$79.70	25-49	\$74.12	50-99	\$68.54	100 +	\$63.76
PRICE																																												
1-24	\$18.10																																											
25-49	\$16.83																																											
50-99	\$15.57																																											
100 +	\$14.48																																											
PRICE																																												
1-24	\$33.49																																											
25-49	\$31.15																																											
50-99	\$28.80																																											
100 +	\$26.79																																											
PRICE																																												
1-24	\$59.02																																											
25-49	\$54.89																																											
50-99	\$50.76																																											
100 +	\$47.22																																											
PRICE																																												
1-24	\$79.70																																											
25-49	\$74.12																																											
50-99	\$68.54																																											
100 +	\$63.76																																											
6	<div style="background-color: black; color: white; padding: 10px; text-align: center;"> <h2>7/16 DIN In-Series</h2> <p>→</p> </div>																																											
	 <table border="1"> <thead> <tr> <th colspan="2">PRICE</th> </tr> </thead> <tbody> <tr> <td>1-24</td> <td>\$81.00</td> </tr> <tr> <td>25-49</td> <td>\$75.33</td> </tr> <tr> <td>50-99</td> <td>\$69.66</td> </tr> <tr> <td>100 +</td> <td>\$64.80</td> </tr> </tbody> </table> <p>PRECISION NEW Model No: PE91039 7/16 Male To 7/16 Male Low PIM, Low VSWR</p>	PRICE		1-24	\$81.00	25-49	\$75.33	50-99	\$69.66	100 +	\$64.80	 <table border="1"> <thead> <tr> <th colspan="2">PRICE</th> </tr> </thead> <tbody> <tr> <td>1-24</td> <td>\$72.00</td> </tr> <tr> <td>25-49</td> <td>\$66.96</td> </tr> <tr> <td>50-99</td> <td>\$61.92</td> </tr> <tr> <td>100 +</td> <td>\$57.60</td> </tr> </tbody> </table> <p>PRECISION NEW Model No: PE91028 7/16 Male To 7/16 Female Low PIM, Low VSWR</p>	PRICE		1-24	\$72.00	25-49	\$66.96	50-99	\$61.92	100 +	\$57.60	 <table border="1"> <thead> <tr> <th colspan="2">PRICE</th> </tr> </thead> <tbody> <tr> <td>1-24</td> <td>\$92.56</td> </tr> <tr> <td>25-49</td> <td>\$86.08</td> </tr> <tr> <td>50-99</td> <td>\$79.60</td> </tr> <tr> <td>100 +</td> <td>\$74.05</td> </tr> </tbody> </table> <p>Model No: PE9555 7/16 Male To 7/16 Male</p>	PRICE		1-24	\$92.56	25-49	\$86.08	50-99	\$79.60	100 +	\$74.05											
PRICE																																												
1-24	\$81.00																																											
25-49	\$75.33																																											
50-99	\$69.66																																											
100 +	\$64.80																																											
PRICE																																												
1-24	\$72.00																																											
25-49	\$66.96																																											
50-99	\$61.92																																											
100 +	\$57.60																																											
PRICE																																												
1-24	\$92.56																																											
25-49	\$86.08																																											
50-99	\$79.60																																											
100 +	\$74.05																																											

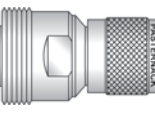
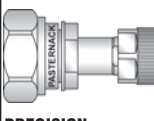
ADAPTERS

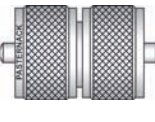
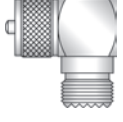
See Adapter Locator on Pages 140-145 or the Adapter Matrix on Pages 138-139

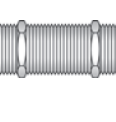
See Page 246 for Mounting Holes

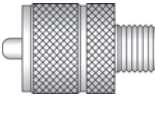
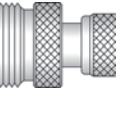
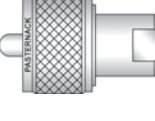
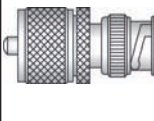
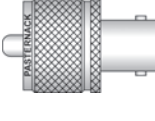
	A	B	C	D																																								
1	 <table border="1"> <thead> <tr> <th colspan="2">PRICE</th> </tr> </thead> <tbody> <tr> <td>1-24</td> <td>\$140.29</td> </tr> <tr> <td>25-49</td> <td>\$130.47</td> </tr> <tr> <td>50-99</td> <td>\$120.65</td> </tr> <tr> <td>100 +</td> <td>\$112.23</td> </tr> </tbody> </table> <p>Model No: PE9410 7/16 Male To 7/16 Female Right Angle</p>	PRICE		1-24	\$140.29	25-49	\$130.47	50-99	\$120.65	100 +	\$112.23	 <table border="1"> <thead> <tr> <th colspan="2">PRICE</th> </tr> </thead> <tbody> <tr> <td>1-24</td> <td>\$72.00</td> </tr> <tr> <td>25-49</td> <td>\$66.96</td> </tr> <tr> <td>50-99</td> <td>\$61.92</td> </tr> <tr> <td>100 +</td> <td>\$57.60</td> </tr> </tbody> </table> <p>PRECISION NEW Model No: PE91029 7/16 Female To 7/16 Female Low PIM, Low VSWR</p>	PRICE		1-24	\$72.00	25-49	\$66.96	50-99	\$61.92	100 +	\$57.60	 <table border="1"> <thead> <tr> <th colspan="2">PRICE</th> </tr> </thead> <tbody> <tr> <td>1-24</td> <td>\$83.39</td> </tr> <tr> <td>25-49</td> <td>\$77.55</td> </tr> <tr> <td>50-99</td> <td>\$71.72</td> </tr> <tr> <td>100 +</td> <td>\$66.71</td> </tr> </tbody> </table> <p>Model No: PE9409 7/16 Female To 7/16 Female</p>	PRICE		1-24	\$83.39	25-49	\$77.55	50-99	\$71.72	100 +	\$66.71	 <table border="1"> <thead> <tr> <th colspan="2">PRICE</th> </tr> </thead> <tbody> <tr> <td>1-24</td> <td>\$102.00</td> </tr> <tr> <td>25-49</td> <td>\$94.86</td> </tr> <tr> <td>50-99</td> <td>\$87.72</td> </tr> <tr> <td>100 +</td> <td>\$81.60</td> </tr> </tbody> </table> <p>PRECISION NEW Model No: PE91038 7/16 Female To 7/16 Female Bulkhead Low PIM, Low VSWR</p>	PRICE		1-24	\$102.00	25-49	\$94.86	50-99	\$87.72	100 +	\$81.60
	PRICE																																											
1-24	\$140.29																																											
25-49	\$130.47																																											
50-99	\$120.65																																											
100 +	\$112.23																																											
PRICE																																												
1-24	\$72.00																																											
25-49	\$66.96																																											
50-99	\$61.92																																											
100 +	\$57.60																																											
PRICE																																												
1-24	\$83.39																																											
25-49	\$77.55																																											
50-99	\$71.72																																											
100 +	\$66.71																																											
PRICE																																												
1-24	\$102.00																																											
25-49	\$94.86																																											
50-99	\$87.72																																											
100 +	\$81.60																																											
2	 <table border="1"> <thead> <tr> <th colspan="2">PRICE</th> </tr> </thead> <tbody> <tr> <td>1-24</td> <td>\$194.25</td> </tr> <tr> <td>25-49</td> <td>\$180.65</td> </tr> <tr> <td>50-99</td> <td>\$167.06</td> </tr> <tr> <td>100 +</td> <td>\$155.40</td> </tr> </tbody> </table> <p>Model No: PE9414 7/16 Female To 7/16 Female Bulkhead</p>	PRICE		1-24	\$194.25	25-49	\$180.65	50-99	\$167.06	100 +	\$155.40	 <table border="1"> <thead> <tr> <th colspan="2">PRICE</th> </tr> </thead> <tbody> <tr> <td>1-24</td> <td>\$164.81</td> </tr> <tr> <td>25-49</td> <td>\$153.27</td> </tr> <tr> <td>50-99</td> <td>\$141.74</td> </tr> <tr> <td>100 +</td> <td>\$131.85</td> </tr> </tbody> </table> <p>Model No: PE9557 7/16 "T" Female-Male-Female</p>	PRICE		1-24	\$164.81	25-49	\$153.27	50-99	\$141.74	100 +	\$131.85	 <table border="1"> <thead> <tr> <th colspan="2">PRICE</th> </tr> </thead> <tbody> <tr> <td>1-24</td> <td>\$164.81</td> </tr> <tr> <td>25-49</td> <td>\$153.27</td> </tr> <tr> <td>50-99</td> <td>\$141.74</td> </tr> <tr> <td>100 +</td> <td>\$131.85</td> </tr> </tbody> </table> <p>Model No: PE9556 7/16 "T" Female-Female-Female</p>	PRICE		1-24	\$164.81	25-49	\$153.27	50-99	\$141.74	100 +	\$131.85	<div style="text-align: center;"> <h2>7/16 DIN Between-Series</h2>  </div>										
	PRICE																																											
1-24	\$194.25																																											
25-49	\$180.65																																											
50-99	\$167.06																																											
100 +	\$155.40																																											
PRICE																																												
1-24	\$164.81																																											
25-49	\$153.27																																											
50-99	\$141.74																																											
100 +	\$131.85																																											
PRICE																																												
1-24	\$164.81																																											
25-49	\$153.27																																											
50-99	\$141.74																																											
100 +	\$131.85																																											
3	 <table border="1"> <thead> <tr> <th colspan="2">PRICE</th> </tr> </thead> <tbody> <tr> <td>1-24</td> <td>\$115.82</td> </tr> <tr> <td>25-49</td> <td>\$107.71</td> </tr> <tr> <td>50-99</td> <td>\$99.61</td> </tr> <tr> <td>100 +</td> <td>\$92.66</td> </tr> </tbody> </table> <p>Model No: PE9558 7/16 Male To HN Female</p>	PRICE		1-24	\$115.82	25-49	\$107.71	50-99	\$99.61	100 +	\$92.66	 <table border="1"> <thead> <tr> <th colspan="2">PRICE</th> </tr> </thead> <tbody> <tr> <td>1-24</td> <td>\$115.67</td> </tr> <tr> <td>25-49</td> <td>\$107.57</td> </tr> <tr> <td>50-99</td> <td>\$99.48</td> </tr> <tr> <td>100 +</td> <td>\$92.54</td> </tr> </tbody> </table> <p>Model No: PE9559 7/16 Female To HN Male</p>	PRICE		1-24	\$115.67	25-49	\$107.57	50-99	\$99.48	100 +	\$92.54	 <table border="1"> <thead> <tr> <th colspan="2">PRICE</th> </tr> </thead> <tbody> <tr> <td>1-24</td> <td>\$306.12</td> </tr> <tr> <td>25-49</td> <td>\$284.69</td> </tr> <tr> <td>50-99</td> <td>\$263.26</td> </tr> <tr> <td>100 +</td> <td>\$244.90</td> </tr> </tbody> </table> <p>PRECISION Model No: PE9509 7/16 Male To 7mm Max VSWR 1.35:1 @ 7 GHz</p>	PRICE		1-24	\$306.12	25-49	\$284.69	50-99	\$263.26	100 +	\$244.90	 <table border="1"> <thead> <tr> <th colspan="2">PRICE</th> </tr> </thead> <tbody> <tr> <td>1-24</td> <td>\$353.24</td> </tr> <tr> <td>25-49</td> <td>\$328.51</td> </tr> <tr> <td>50-99</td> <td>\$303.79</td> </tr> <tr> <td>100 +</td> <td>\$282.59</td> </tr> </tbody> </table> <p>PRECISION Model No: PE9510 7/16 Female To 7mm Max VSWR 1.35:1 @ 7 GHz</p>	PRICE		1-24	\$353.24	25-49	\$328.51	50-99	\$303.79	100 +	\$282.59
	PRICE																																											
1-24	\$115.82																																											
25-49	\$107.71																																											
50-99	\$99.61																																											
100 +	\$92.66																																											
PRICE																																												
1-24	\$115.67																																											
25-49	\$107.57																																											
50-99	\$99.48																																											
100 +	\$92.54																																											
PRICE																																												
1-24	\$306.12																																											
25-49	\$284.69																																											
50-99	\$263.26																																											
100 +	\$244.90																																											
PRICE																																												
1-24	\$353.24																																											
25-49	\$328.51																																											
50-99	\$303.79																																											
100 +	\$282.59																																											
4	<div style="text-align: center;"> <h2>UHF In-Series</h2>  </div>	 <table border="1"> <thead> <tr> <th colspan="2">PRICE</th> </tr> </thead> <tbody> <tr> <td>1-24</td> <td>\$9.91</td> </tr> <tr> <td>25-49</td> <td>\$9.22</td> </tr> <tr> <td>50-99</td> <td>\$8.52</td> </tr> <tr> <td>100 +</td> <td>\$7.93</td> </tr> </tbody> </table> <p>Model No: PE9096 UHF Male To UHF Male</p>	PRICE		1-24	\$9.91	25-49	\$9.22	50-99	\$8.52	100 +	\$7.93	 <table border="1"> <thead> <tr> <th colspan="2">PRICE</th> </tr> </thead> <tbody> <tr> <td>1-24</td> <td>\$14.74</td> </tr> <tr> <td>25-49</td> <td>\$13.71</td> </tr> <tr> <td>50-99</td> <td>\$12.68</td> </tr> <tr> <td>100 +</td> <td>\$11.79</td> </tr> </tbody> </table> <p>Model No: PE9209 UHF Male To UHF Female Right Angle</p>	PRICE		1-24	\$14.74	25-49	\$13.71	50-99	\$12.68	100 +	\$11.79	 <table border="1"> <thead> <tr> <th colspan="2">PRICE</th> </tr> </thead> <tbody> <tr> <td>1-24</td> <td>\$8.76</td> </tr> <tr> <td>25-49</td> <td>\$8.15</td> </tr> <tr> <td>50-99</td> <td>\$7.53</td> </tr> <tr> <td>100 +</td> <td>\$7.01</td> </tr> </tbody> </table> <p>Model No: PE9094 UHF Female To UHF Female</p>	PRICE		1-24	\$8.76	25-49	\$8.15	50-99	\$7.53	100 +	\$7.01										
		PRICE																																										
1-24	\$9.91																																											
25-49	\$9.22																																											
50-99	\$8.52																																											
100 +	\$7.93																																											
PRICE																																												
1-24	\$14.74																																											
25-49	\$13.71																																											
50-99	\$12.68																																											
100 +	\$11.79																																											
PRICE																																												
1-24	\$8.76																																											
25-49	\$8.15																																											
50-99	\$7.53																																											
100 +	\$7.01																																											
5	 <table border="1"> <thead> <tr> <th colspan="2">PRICE</th> </tr> </thead> <tbody> <tr> <td>1-24</td> <td>\$32.53</td> </tr> <tr> <td>25-49</td> <td>\$30.25</td> </tr> <tr> <td>50-99</td> <td>\$27.98</td> </tr> <tr> <td>100 +</td> <td>\$26.02</td> </tr> </tbody> </table> <p>Model No: PE9114 UHF Female To UHF Female Bulkhead Mounting Hole F03</p>	PRICE		1-24	\$32.53	25-49	\$30.25	50-99	\$27.98	100 +	\$26.02	 <table border="1"> <thead> <tr> <th colspan="2">PRICE</th> </tr> </thead> <tbody> <tr> <td>1-24</td> <td>\$14.69</td> </tr> <tr> <td>25-49</td> <td>\$13.66</td> </tr> <tr> <td>50-99</td> <td>\$12.63</td> </tr> <tr> <td>100 +</td> <td>\$11.75</td> </tr> </tbody> </table> <p>Model No: PE9095 UHF "T" Female-Male-Female</p>	PRICE		1-24	\$14.69	25-49	\$13.66	50-99	\$12.63	100 +	\$11.75	<div style="text-align: center;"> <h2>UHF Between-Series</h2>  </div>	 <table border="1"> <thead> <tr> <th colspan="2">PRICE</th> </tr> </thead> <tbody> <tr> <td>1-24</td> <td>\$10.99</td> </tr> <tr> <td>25-49</td> <td>\$10.22</td> </tr> <tr> <td>50-99</td> <td>\$9.45</td> </tr> <tr> <td>100 +</td> <td>\$8.79</td> </tr> </tbody> </table> <p>Model No: PE9348 UHF Male To Mini-UHF Female</p>	PRICE		1-24	\$10.99	25-49	\$10.22	50-99	\$9.45	100 +	\$8.79										
	PRICE																																											
1-24	\$32.53																																											
25-49	\$30.25																																											
50-99	\$27.98																																											
100 +	\$26.02																																											
PRICE																																												
1-24	\$14.69																																											
25-49	\$13.66																																											
50-99	\$12.63																																											
100 +	\$11.75																																											
PRICE																																												
1-24	\$10.99																																											
25-49	\$10.22																																											
50-99	\$9.45																																											
100 +	\$8.79																																											
6	 <table border="1"> <thead> <tr> <th colspan="2">PRICE</th> </tr> </thead> <tbody> <tr> <td>1-24</td> <td>\$11.75</td> </tr> <tr> <td>25-49</td> <td>\$10.93</td> </tr> <tr> <td>50-99</td> <td>\$10.11</td> </tr> <tr> <td>100 +</td> <td>\$9.40</td> </tr> </tbody> </table> <p>Model No: PE9344 UHF Female To Mini-UHF Male</p>	PRICE		1-24	\$11.75	25-49	\$10.93	50-99	\$10.11	100 +	\$9.40	 <table border="1"> <thead> <tr> <th colspan="2">PRICE</th> </tr> </thead> <tbody> <tr> <td>1-24</td> <td>\$11.70</td> </tr> <tr> <td>25-49</td> <td>\$10.88</td> </tr> <tr> <td>50-99</td> <td>\$10.06</td> </tr> <tr> <td>100 +</td> <td>\$9.36</td> </tr> </tbody> </table> <p>Model No: PE9701 UHF Male To FME Plug</p>	PRICE		1-24	\$11.70	25-49	\$10.88	50-99	\$10.06	100 +	\$9.36	 <table border="1"> <thead> <tr> <th colspan="2">PRICE</th> </tr> </thead> <tbody> <tr> <td>1-24</td> <td>\$18.34</td> </tr> <tr> <td>25-49</td> <td>\$17.06</td> </tr> <tr> <td>50-99</td> <td>\$15.77</td> </tr> <tr> <td>100 +</td> <td>\$14.67</td> </tr> </tbody> </table> <p>Model No: PE9201 UHF Male To BNC Male</p>	PRICE		1-24	\$18.34	25-49	\$17.06	50-99	\$15.77	100 +	\$14.67	 <table border="1"> <thead> <tr> <th colspan="2">PRICE</th> </tr> </thead> <tbody> <tr> <td>1-24</td> <td>\$11.49</td> </tr> <tr> <td>25-49</td> <td>\$10.69</td> </tr> <tr> <td>50-99</td> <td>\$9.88</td> </tr> <tr> <td>100 +</td> <td>\$9.19</td> </tr> </tbody> </table> <p>Model No: PE9004 UHF Male To BNC Female</p>	PRICE		1-24	\$11.49	25-49	\$10.69	50-99	\$9.88	100 +	\$9.19
	PRICE																																											
1-24	\$11.75																																											
25-49	\$10.93																																											
50-99	\$10.11																																											
100 +	\$9.40																																											
PRICE																																												
1-24	\$11.70																																											
25-49	\$10.88																																											
50-99	\$10.06																																											
100 +	\$9.36																																											
PRICE																																												
1-24	\$18.34																																											
25-49	\$17.06																																											
50-99	\$15.77																																											
100 +	\$14.67																																											
PRICE																																												
1-24	\$11.49																																											
25-49	\$10.69																																											
50-99	\$9.88																																											
100 +	\$9.19																																											

Adapters

See Our Website For Real-Time Stock Availability!



Free Freight Available
via UPS Ground
to USA & Canada



Real-Time Stock
Levels & Pricing
On Our Website



Toll-Free Technical
Support
(866) 727-8376



Same-Day Shipping,
Even Custom
Cable Assemblies







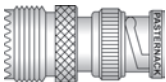

ADAPTERS

See Adapter Locator on Pages 140-145 or the Adapter Matrix on Pages 138-139

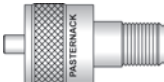
See Page 246 for Mounting Holes

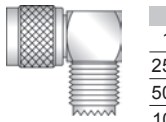
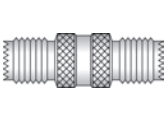
Adapters

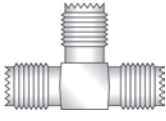
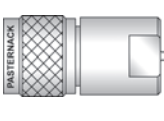
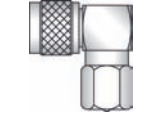
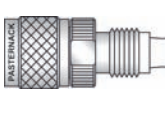
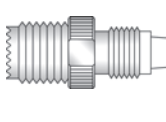
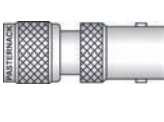
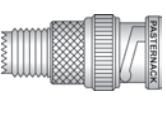
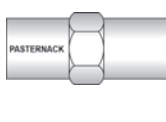
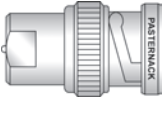
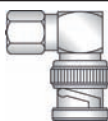
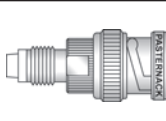









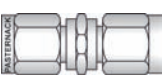

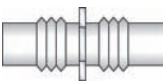

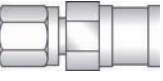
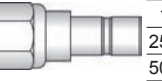
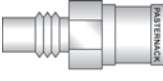
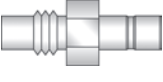

See Our Website For Real-Time Stock Availability!

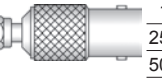
	A	B	C	D																																								
1	 <table border="1"> <thead> <tr> <th colspan="2">PRICE</th> </tr> </thead> <tbody> <tr> <td>1-24</td> <td>\$11.22</td> </tr> <tr> <td>25-49</td> <td>\$10.43</td> </tr> <tr> <td>50-99</td> <td>\$9.65</td> </tr> <tr> <td>100 +</td> <td>\$8.98</td> </tr> </tbody> </table> <p>Model No: PE9107 UHF Female To BNC Male</p>	PRICE		1-24	\$11.22	25-49	\$10.43	50-99	\$9.65	100 +	\$8.98	 <table border="1"> <thead> <tr> <th colspan="2">PRICE</th> </tr> </thead> <tbody> <tr> <td>1-24</td> <td>\$15.66</td> </tr> <tr> <td>25-49</td> <td>\$14.56</td> </tr> <tr> <td>50-99</td> <td>\$13.47</td> </tr> <tr> <td>100 +</td> <td>\$12.53</td> </tr> </tbody> </table> <p>Model No: PE9421 UHF Female To BNC Female</p>	PRICE		1-24	\$15.66	25-49	\$14.56	50-99	\$13.47	100 +	\$12.53	 <table border="1"> <thead> <tr> <th colspan="2">PRICE</th> </tr> </thead> <tbody> <tr> <td>1-24</td> <td>\$23.36</td> </tr> <tr> <td>25-49</td> <td>\$21.72</td> </tr> <tr> <td>50-99</td> <td>\$20.09</td> </tr> <tr> <td>100 +</td> <td>\$18.69</td> </tr> </tbody> </table> <p>Model No: PE9165 UHF Male To F Female</p>	PRICE		1-24	\$23.36	25-49	\$21.72	50-99	\$20.09	100 +	\$18.69	 <table border="1"> <thead> <tr> <th colspan="2">PRICE</th> </tr> </thead> <tbody> <tr> <td>1-24</td> <td>\$23.36</td> </tr> <tr> <td>25-49</td> <td>\$21.72</td> </tr> <tr> <td>50-99</td> <td>\$20.09</td> </tr> <tr> <td>100 +</td> <td>\$18.69</td> </tr> </tbody> </table> <p>Model No: PE9167 UHF Female To F Female</p>	PRICE		1-24	\$23.36	25-49	\$21.72	50-99	\$20.09	100 +	\$18.69
PRICE																																												
1-24	\$11.22																																											
25-49	\$10.43																																											
50-99	\$9.65																																											
100 +	\$8.98																																											
PRICE																																												
1-24	\$15.66																																											
25-49	\$14.56																																											
50-99	\$13.47																																											
100 +	\$12.53																																											
PRICE																																												
1-24	\$23.36																																											
25-49	\$21.72																																											
50-99	\$20.09																																											
100 +	\$18.69																																											
PRICE																																												
1-24	\$23.36																																											
25-49	\$21.72																																											
50-99	\$20.09																																											
100 +	\$18.69																																											
2	<p>Mini UHF In-Series</p> <p>→</p>	 <table border="1"> <thead> <tr> <th colspan="2">PRICE</th> </tr> </thead> <tbody> <tr> <td>1-24</td> <td>\$11.04</td> </tr> <tr> <td>25-49</td> <td>\$10.27</td> </tr> <tr> <td>50-99</td> <td>\$9.49</td> </tr> <tr> <td>100 +</td> <td>\$8.83</td> </tr> </tbody> </table> <p>Model No: PE9347 Mini UHF Male To Mini UHF Female Right Angle</p>	PRICE		1-24	\$11.04	25-49	\$10.27	50-99	\$9.49	100 +	\$8.83	 <table border="1"> <thead> <tr> <th colspan="2">PRICE</th> </tr> </thead> <tbody> <tr> <td>1-24</td> <td>\$10.99</td> </tr> <tr> <td>25-49</td> <td>\$10.22</td> </tr> <tr> <td>50-99</td> <td>\$9.45</td> </tr> <tr> <td>100 +</td> <td>\$8.79</td> </tr> </tbody> </table> <p>Model No: PE9343 Mini UHF Female To Mini UHF Female</p>	PRICE		1-24	\$10.99	25-49	\$10.22	50-99	\$9.45	100 +	\$8.79	 <table border="1"> <thead> <tr> <th colspan="2">PRICE</th> </tr> </thead> <tbody> <tr> <td>1-24</td> <td>\$9.73</td> </tr> <tr> <td>25-49</td> <td>\$9.05</td> </tr> <tr> <td>50-99</td> <td>\$8.37</td> </tr> <tr> <td>100 +</td> <td>\$7.78</td> </tr> </tbody> </table> <p>Model No: PE9065 Mini UHF "T" Female-Male-Female</p>	PRICE		1-24	\$9.73	25-49	\$9.05	50-99	\$8.37	100 +	\$7.78										
PRICE																																												
1-24	\$11.04																																											
25-49	\$10.27																																											
50-99	\$9.49																																											
100 +	\$8.83																																											
PRICE																																												
1-24	\$10.99																																											
25-49	\$10.22																																											
50-99	\$9.45																																											
100 +	\$8.79																																											
PRICE																																												
1-24	\$9.73																																											
25-49	\$9.05																																											
50-99	\$8.37																																											
100 +	\$7.78																																											
3	 <table border="1"> <thead> <tr> <th colspan="2">PRICE</th> </tr> </thead> <tbody> <tr> <td>1-24</td> <td>\$10.99</td> </tr> <tr> <td>25-49</td> <td>\$10.22</td> </tr> <tr> <td>50-99</td> <td>\$9.45</td> </tr> <tr> <td>100 +</td> <td>\$8.79</td> </tr> </tbody> </table> <p>Model No: PE9066 Mini UHF "T" Female-Female-Female</p>	PRICE		1-24	\$10.99	25-49	\$10.22	50-99	\$9.45	100 +	\$8.79	<p>Mini UHF Between-Series</p> <p>→</p>	 <table border="1"> <thead> <tr> <th colspan="2">PRICE</th> </tr> </thead> <tbody> <tr> <td>1-24</td> <td>\$11.70</td> </tr> <tr> <td>25-49</td> <td>\$10.88</td> </tr> <tr> <td>50-99</td> <td>\$10.06</td> </tr> <tr> <td>100 +</td> <td>\$9.36</td> </tr> </tbody> </table> <p>Model No: PE9705 Mini UHF Male To FME Plug</p>	PRICE		1-24	\$11.70	25-49	\$10.88	50-99	\$10.06	100 +	\$9.36	 <table border="1"> <thead> <tr> <th colspan="2">PRICE</th> </tr> </thead> <tbody> <tr> <td>1-24</td> <td>\$11.70</td> </tr> <tr> <td>25-49</td> <td>\$10.88</td> </tr> <tr> <td>50-99</td> <td>\$10.06</td> </tr> <tr> <td>100 +</td> <td>\$9.36</td> </tr> </tbody> </table> <p>Model No: PE9706 Mini UHF Male To FME Plug Right Angle</p>	PRICE		1-24	\$11.70	25-49	\$10.88	50-99	\$10.06	100 +	\$9.36										
PRICE																																												
1-24	\$10.99																																											
25-49	\$10.22																																											
50-99	\$9.45																																											
100 +	\$8.79																																											
PRICE																																												
1-24	\$11.70																																											
25-49	\$10.88																																											
50-99	\$10.06																																											
100 +	\$9.36																																											
PRICE																																												
1-24	\$11.70																																											
25-49	\$10.88																																											
50-99	\$10.06																																											
100 +	\$9.36																																											
4	 <table border="1"> <thead> <tr> <th colspan="2">PRICE</th> </tr> </thead> <tbody> <tr> <td>1-24</td> <td>\$11.70</td> </tr> <tr> <td>25-49</td> <td>\$10.88</td> </tr> <tr> <td>50-99</td> <td>\$10.06</td> </tr> <tr> <td>100 +</td> <td>\$9.36</td> </tr> </tbody> </table> <p>Model No: PE9709 Mini UHF Male To FME Jack</p>	PRICE		1-24	\$11.70	25-49	\$10.88	50-99	\$10.06	100 +	\$9.36	 <table border="1"> <thead> <tr> <th colspan="2">PRICE</th> </tr> </thead> <tbody> <tr> <td>1-24</td> <td>\$11.70</td> </tr> <tr> <td>25-49</td> <td>\$10.88</td> </tr> <tr> <td>50-99</td> <td>\$10.06</td> </tr> <tr> <td>100 +</td> <td>\$9.36</td> </tr> </tbody> </table> <p>Model No: PE9710 Mini UHF Female To FME Jack</p>	PRICE		1-24	\$11.70	25-49	\$10.88	50-99	\$10.06	100 +	\$9.36	 <table border="1"> <thead> <tr> <th colspan="2">PRICE</th> </tr> </thead> <tbody> <tr> <td>1-24</td> <td>\$11.22</td> </tr> <tr> <td>25-49</td> <td>\$10.43</td> </tr> <tr> <td>50-99</td> <td>\$9.65</td> </tr> <tr> <td>100 +</td> <td>\$8.98</td> </tr> </tbody> </table> <p>Model No: PE9342 Mini UHF Male To BNC Female</p>	PRICE		1-24	\$11.22	25-49	\$10.43	50-99	\$9.65	100 +	\$8.98	 <table border="1"> <thead> <tr> <th colspan="2">PRICE</th> </tr> </thead> <tbody> <tr> <td>1-24</td> <td>\$10.99</td> </tr> <tr> <td>25-49</td> <td>\$10.22</td> </tr> <tr> <td>50-99</td> <td>\$9.45</td> </tr> <tr> <td>100 +</td> <td>\$8.79</td> </tr> </tbody> </table> <p>Model No: PE9341 Mini UHF Female To BNC Male</p>	PRICE		1-24	\$10.99	25-49	\$10.22	50-99	\$9.45	100 +	\$8.79
PRICE																																												
1-24	\$11.70																																											
25-49	\$10.88																																											
50-99	\$10.06																																											
100 +	\$9.36																																											
PRICE																																												
1-24	\$11.70																																											
25-49	\$10.88																																											
50-99	\$10.06																																											
100 +	\$9.36																																											
PRICE																																												
1-24	\$11.22																																											
25-49	\$10.43																																											
50-99	\$9.65																																											
100 +	\$8.98																																											
PRICE																																												
1-24	\$10.99																																											
25-49	\$10.22																																											
50-99	\$9.45																																											
100 +	\$8.79																																											
5	<p>FME In-Series</p> <p>→</p>	 <table border="1"> <thead> <tr> <th colspan="2">PRICE</th> </tr> </thead> <tbody> <tr> <td>1-24</td> <td>\$11.70</td> </tr> <tr> <td>25-49</td> <td>\$10.88</td> </tr> <tr> <td>50-99</td> <td>\$10.06</td> </tr> <tr> <td>100 +</td> <td>\$9.36</td> </tr> </tbody> </table> <p>Model No: PE9696 FME Plug To FME Plug</p>	PRICE		1-24	\$11.70	25-49	\$10.88	50-99	\$10.06	100 +	\$9.36	<p>FME Between-Series</p> <p>→</p>	 <table border="1"> <thead> <tr> <th colspan="2">PRICE</th> </tr> </thead> <tbody> <tr> <td>1-24</td> <td>\$11.70</td> </tr> <tr> <td>25-49</td> <td>\$10.88</td> </tr> <tr> <td>50-99</td> <td>\$10.06</td> </tr> <tr> <td>100 +</td> <td>\$9.36</td> </tr> </tbody> </table> <p>Model No: PE9697 FME Plug To BNC Male</p>	PRICE		1-24	\$11.70	25-49	\$10.88	50-99	\$10.06	100 +	\$9.36																				
PRICE																																												
1-24	\$11.70																																											
25-49	\$10.88																																											
50-99	\$10.06																																											
100 +	\$9.36																																											
PRICE																																												
1-24	\$11.70																																											
25-49	\$10.88																																											
50-99	\$10.06																																											
100 +	\$9.36																																											
6	 <table border="1"> <thead> <tr> <th colspan="2">PRICE</th> </tr> </thead> <tbody> <tr> <td>1-24</td> <td>\$11.70</td> </tr> <tr> <td>25-49</td> <td>\$10.88</td> </tr> <tr> <td>50-99</td> <td>\$10.06</td> </tr> <tr> <td>100 +</td> <td>\$9.36</td> </tr> </tbody> </table> <p>Model No: PE9698 FME Plug To BNC Male Right Angle</p>	PRICE		1-24	\$11.70	25-49	\$10.88	50-99	\$10.06	100 +	\$9.36	 <table border="1"> <thead> <tr> <th colspan="2">PRICE</th> </tr> </thead> <tbody> <tr> <td>1-24</td> <td>\$11.70</td> </tr> <tr> <td>25-49</td> <td>\$10.88</td> </tr> <tr> <td>50-99</td> <td>\$10.06</td> </tr> <tr> <td>100 +</td> <td>\$9.36</td> </tr> </tbody> </table> <p>Model No: PE9711 FME Jack To BNC Male</p>	PRICE		1-24	\$11.70	25-49	\$10.88	50-99	\$10.06	100 +	\$9.36	 <table border="1"> <thead> <tr> <th colspan="2">PRICE</th> </tr> </thead> <tbody> <tr> <td>1-24</td> <td>\$12.92</td> </tr> <tr> <td>25-49</td> <td>\$12.02</td> </tr> <tr> <td>50-99</td> <td>\$11.11</td> </tr> <tr> <td>100 +</td> <td>\$10.34</td> </tr> </tbody> </table> <p>Model No: PE9712 FME Jack To BNC Female</p>	PRICE		1-24	\$12.92	25-49	\$12.02	50-99	\$11.11	100 +	\$10.34	<p>SMC In-Series</p> <p>→</p>										
PRICE																																												
1-24	\$11.70																																											
25-49	\$10.88																																											
50-99	\$10.06																																											
100 +	\$9.36																																											
PRICE																																												
1-24	\$11.70																																											
25-49	\$10.88																																											
50-99	\$10.06																																											
100 +	\$9.36																																											
PRICE																																												
1-24	\$12.92																																											
25-49	\$12.02																																											
50-99	\$11.11																																											
100 +	\$10.34																																											

ADAPTERS

See Adapter Locator on Pages 140-145 or the Adapter Matrix on Pages 138-139

See Page 246 for Mounting Holes

	A	B	C	D																																								
1	 <table border="1"> <thead> <tr> <th colspan="2">PRICE</th> </tr> </thead> <tbody> <tr> <td>1-24</td> <td>\$20.87</td> </tr> <tr> <td>25-49</td> <td>\$19.41</td> </tr> <tr> <td>50-99</td> <td>\$17.95</td> </tr> <tr> <td>100 +</td> <td>\$16.70</td> </tr> </tbody> </table> <p>Model No: PE9117 SMC Plug To SMC Plug</p>	PRICE		1-24	\$20.87	25-49	\$19.41	50-99	\$17.95	100 +	\$16.70	 <table border="1"> <thead> <tr> <th colspan="2">PRICE</th> </tr> </thead> <tbody> <tr> <td>1-24</td> <td>\$38.45</td> </tr> <tr> <td>25-49</td> <td>\$35.76</td> </tr> <tr> <td>50-99</td> <td>\$33.07</td> </tr> <tr> <td>100 +</td> <td>\$30.76</td> </tr> </tbody> </table> <p>Model No: PE9119 SMC Plug To SMC Jack</p>	PRICE		1-24	\$38.45	25-49	\$35.76	50-99	\$33.07	100 +	\$30.76	 <table border="1"> <thead> <tr> <th colspan="2">PRICE</th> </tr> </thead> <tbody> <tr> <td>1-24</td> <td>\$41.14</td> </tr> <tr> <td>25-49</td> <td>\$38.26</td> </tr> <tr> <td>50-99</td> <td>\$35.38</td> </tr> <tr> <td>100 +</td> <td>\$32.91</td> </tr> </tbody> </table> <p>Model No: PE9303 SMC Plug To SMC Jack Right Angle</p>	PRICE		1-24	\$41.14	25-49	\$38.26	50-99	\$35.38	100 +	\$32.91	 <table border="1"> <thead> <tr> <th colspan="2">PRICE</th> </tr> </thead> <tbody> <tr> <td>1-24</td> <td>\$20.87</td> </tr> <tr> <td>25-49</td> <td>\$19.41</td> </tr> <tr> <td>50-99</td> <td>\$17.95</td> </tr> <tr> <td>100 +</td> <td>\$16.70</td> </tr> </tbody> </table> <p>Model No: PE9115 SMC Jack To SMC Jack</p>	PRICE		1-24	\$20.87	25-49	\$19.41	50-99	\$17.95	100 +	\$16.70
	PRICE																																											
1-24	\$20.87																																											
25-49	\$19.41																																											
50-99	\$17.95																																											
100 +	\$16.70																																											
PRICE																																												
1-24	\$38.45																																											
25-49	\$35.76																																											
50-99	\$33.07																																											
100 +	\$30.76																																											
PRICE																																												
1-24	\$41.14																																											
25-49	\$38.26																																											
50-99	\$35.38																																											
100 +	\$32.91																																											
PRICE																																												
1-24	\$20.87																																											
25-49	\$19.41																																											
50-99	\$17.95																																											
100 +	\$16.70																																											
2	 <table border="1"> <thead> <tr> <th colspan="2">PRICE</th> </tr> </thead> <tbody> <tr> <td>1-24</td> <td>\$24.17</td> </tr> <tr> <td>25-49</td> <td>\$22.48</td> </tr> <tr> <td>50-99</td> <td>\$20.79</td> </tr> <tr> <td>100 +</td> <td>\$19.34</td> </tr> </tbody> </table> <p>Model No: PE9121 SMC Jack To SMC Jack Bulkhead Mounting Hole B01</p>	PRICE		1-24	\$24.17	25-49	\$22.48	50-99	\$20.79	100 +	\$19.34	 <table border="1"> <thead> <tr> <th colspan="2">PRICE</th> </tr> </thead> <tbody> <tr> <td>1-24</td> <td>\$41.14</td> </tr> <tr> <td>25-49</td> <td>\$38.26</td> </tr> <tr> <td>50-99</td> <td>\$35.38</td> </tr> <tr> <td>100 +</td> <td>\$32.91</td> </tr> </tbody> </table> <p>Model No: PE9305 SMC "T" Plug-Plug-Plug</p>	PRICE		1-24	\$41.14	25-49	\$38.26	50-99	\$35.38	100 +	\$32.91	 <table border="1"> <thead> <tr> <th colspan="2">PRICE</th> </tr> </thead> <tbody> <tr> <td>1-24</td> <td>\$28.27</td> </tr> <tr> <td>25-49</td> <td>\$26.29</td> </tr> <tr> <td>50-99</td> <td>\$24.31</td> </tr> <tr> <td>100 +</td> <td>\$22.62</td> </tr> </tbody> </table> <p>Model No: PE9242 SMC "T" Jack-Plug-Jack</p>	PRICE		1-24	\$28.27	25-49	\$26.29	50-99	\$24.31	100 +	\$22.62	 <table border="1"> <thead> <tr> <th colspan="2">PRICE</th> </tr> </thead> <tbody> <tr> <td>1-24</td> <td>\$47.12</td> </tr> <tr> <td>25-49</td> <td>\$43.82</td> </tr> <tr> <td>50-99</td> <td>\$40.52</td> </tr> <tr> <td>100 +</td> <td>\$37.70</td> </tr> </tbody> </table> <p>Model No: PE9304 SMC "T" Jack-Jack-Jack</p>	PRICE		1-24	\$47.12	25-49	\$43.82	50-99	\$40.52	100 +	\$37.70
	PRICE																																											
1-24	\$24.17																																											
25-49	\$22.48																																											
50-99	\$20.79																																											
100 +	\$19.34																																											
PRICE																																												
1-24	\$41.14																																											
25-49	\$38.26																																											
50-99	\$35.38																																											
100 +	\$32.91																																											
PRICE																																												
1-24	\$28.27																																											
25-49	\$26.29																																											
50-99	\$24.31																																											
100 +	\$22.62																																											
PRICE																																												
1-24	\$47.12																																											
25-49	\$43.82																																											
50-99	\$40.52																																											
100 +	\$37.70																																											
3	<p style="text-align: center;">SMC <i>Between-Series</i></p> <p style="text-align: center;">→</p>	 <table border="1"> <thead> <tr> <th colspan="2">PRICE</th> </tr> </thead> <tbody> <tr> <td>1-24</td> <td>\$29.39</td> </tr> <tr> <td>25-49</td> <td>\$27.33</td> </tr> <tr> <td>50-99</td> <td>\$25.28</td> </tr> <tr> <td>100 +</td> <td>\$23.51</td> </tr> </tbody> </table> <p>Model No: PE9281 SMC Plug To SMB Plug</p>	PRICE		1-24	\$29.39	25-49	\$27.33	50-99	\$25.28	100 +	\$23.51	 <table border="1"> <thead> <tr> <th colspan="2">PRICE</th> </tr> </thead> <tbody> <tr> <td>1-24</td> <td>\$29.39</td> </tr> <tr> <td>25-49</td> <td>\$27.33</td> </tr> <tr> <td>50-99</td> <td>\$25.28</td> </tr> <tr> <td>100 +</td> <td>\$23.51</td> </tr> </tbody> </table> <p>Model No: PE9284 SMC Plug To SMB Jack</p>	PRICE		1-24	\$29.39	25-49	\$27.33	50-99	\$25.28	100 +	\$23.51	 <table border="1"> <thead> <tr> <th colspan="2">PRICE</th> </tr> </thead> <tbody> <tr> <td>1-24</td> <td>\$30.35</td> </tr> <tr> <td>25-49</td> <td>\$28.23</td> </tr> <tr> <td>50-99</td> <td>\$26.10</td> </tr> <tr> <td>100 +</td> <td>\$24.28</td> </tr> </tbody> </table> <p>Model No: PE9282 SMC Jack To SMB Plug</p>	PRICE		1-24	\$30.35	25-49	\$28.23	50-99	\$26.10	100 +	\$24.28										
	PRICE																																											
1-24	\$29.39																																											
25-49	\$27.33																																											
50-99	\$25.28																																											
100 +	\$23.51																																											
PRICE																																												
1-24	\$29.39																																											
25-49	\$27.33																																											
50-99	\$25.28																																											
100 +	\$23.51																																											
PRICE																																												
1-24	\$30.35																																											
25-49	\$28.23																																											
50-99	\$26.10																																											
100 +	\$24.28																																											
4	 <table border="1"> <thead> <tr> <th colspan="2">PRICE</th> </tr> </thead> <tbody> <tr> <td>1-24</td> <td>\$29.39</td> </tr> <tr> <td>25-49</td> <td>\$27.33</td> </tr> <tr> <td>50-99</td> <td>\$25.28</td> </tr> <tr> <td>100 +</td> <td>\$23.51</td> </tr> </tbody> </table> <p>Model No: PE9283 SMC Jack To SMB Jack</p>	PRICE		1-24	\$29.39	25-49	\$27.33	50-99	\$25.28	100 +	\$23.51	 <table border="1"> <thead> <tr> <th colspan="2">PRICE</th> </tr> </thead> <tbody> <tr> <td>1-24</td> <td>\$39.32</td> </tr> <tr> <td>25-49</td> <td>\$36.57</td> </tr> <tr> <td>50-99</td> <td>\$33.82</td> </tr> <tr> <td>100 +</td> <td>\$31.46</td> </tr> </tbody> </table> <p>Model No: PE9139 SMC Plug To BNC Male</p>	PRICE		1-24	\$39.32	25-49	\$36.57	50-99	\$33.82	100 +	\$31.46	 <table border="1"> <thead> <tr> <th colspan="2">PRICE</th> </tr> </thead> <tbody> <tr> <td>1-24</td> <td>\$38.71</td> </tr> <tr> <td>25-49</td> <td>\$36.00</td> </tr> <tr> <td>50-99</td> <td>\$33.29</td> </tr> <tr> <td>100 +</td> <td>\$30.97</td> </tr> </tbody> </table> <p>Model No: PE9141 SMC Plug To BNC Female</p>	PRICE		1-24	\$38.71	25-49	\$36.00	50-99	\$33.29	100 +	\$30.97	 <table border="1"> <thead> <tr> <th colspan="2">PRICE</th> </tr> </thead> <tbody> <tr> <td>1-24</td> <td>\$38.71</td> </tr> <tr> <td>25-49</td> <td>\$36.00</td> </tr> <tr> <td>50-99</td> <td>\$33.29</td> </tr> <tr> <td>100 +</td> <td>\$30.97</td> </tr> </tbody> </table> <p>Model No: PE9138 SMC Jack To BNC Male</p>	PRICE		1-24	\$38.71	25-49	\$36.00	50-99	\$33.29	100 +	\$30.97
	PRICE																																											
1-24	\$29.39																																											
25-49	\$27.33																																											
50-99	\$25.28																																											
100 +	\$23.51																																											
PRICE																																												
1-24	\$39.32																																											
25-49	\$36.57																																											
50-99	\$33.82																																											
100 +	\$31.46																																											
PRICE																																												
1-24	\$38.71																																											
25-49	\$36.00																																											
50-99	\$33.29																																											
100 +	\$30.97																																											
PRICE																																												
1-24	\$38.71																																											
25-49	\$36.00																																											
50-99	\$33.29																																											
100 +	\$30.97																																											
5	 <table border="1"> <thead> <tr> <th colspan="2">PRICE</th> </tr> </thead> <tbody> <tr> <td>1-24</td> <td>\$75.64</td> </tr> <tr> <td>25-49</td> <td>\$70.35</td> </tr> <tr> <td>50-99</td> <td>\$65.05</td> </tr> <tr> <td>100 +</td> <td>\$60.51</td> </tr> </tbody> </table> <p>Model No: PE9140 SMC Jack To BNC Female</p>	PRICE		1-24	\$75.64	25-49	\$70.35	50-99	\$65.05	100 +	\$60.51	 <table border="1"> <thead> <tr> <th colspan="2">PRICE</th> </tr> </thead> <tbody> <tr> <td>1-24</td> <td>\$52.14</td> </tr> <tr> <td>25-49</td> <td>\$48.49</td> </tr> <tr> <td>50-99</td> <td>\$44.84</td> </tr> <tr> <td>100 +</td> <td>\$41.71</td> </tr> </tbody> </table> <p>Model No: PE9108 SMC Jack Bulkhead To BNC Female Mounting Hole B04</p>	PRICE		1-24	\$52.14	25-49	\$48.49	50-99	\$44.84	100 +	\$41.71	<p style="text-align: center;">10-32 <i>In-Series</i></p> <p style="text-align: center;">→</p>	 <table border="1"> <thead> <tr> <th colspan="2">PRICE</th> </tr> </thead> <tbody> <tr> <td>1-24</td> <td>\$35.26</td> </tr> <tr> <td>25-49</td> <td>\$32.79</td> </tr> <tr> <td>50-99</td> <td>\$30.32</td> </tr> <tr> <td>100 +</td> <td>\$28.21</td> </tr> </tbody> </table> <p>Model No: PE9756 10-32 Female To 10-32 Female</p>	PRICE		1-24	\$35.26	25-49	\$32.79	50-99	\$30.32	100 +	\$28.21										
	PRICE																																											
1-24	\$75.64																																											
25-49	\$70.35																																											
50-99	\$65.05																																											
100 +	\$60.51																																											
PRICE																																												
1-24	\$52.14																																											
25-49	\$48.49																																											
50-99	\$44.84																																											
100 +	\$41.71																																											
PRICE																																												
1-24	\$35.26																																											
25-49	\$32.79																																											
50-99	\$30.32																																											
100 +	\$28.21																																											
6	 <table border="1"> <thead> <tr> <th colspan="2">PRICE</th> </tr> </thead> <tbody> <tr> <td>1-24</td> <td>\$47.12</td> </tr> <tr> <td>25-49</td> <td>\$43.82</td> </tr> <tr> <td>50-99</td> <td>\$40.52</td> </tr> <tr> <td>100 +</td> <td>\$37.70</td> </tr> </tbody> </table> <p>Model No: PE9757 10-32 Female To 10-32 Female Bulkhead, Mounting Hole B03</p>	PRICE		1-24	\$47.12	25-49	\$43.82	50-99	\$40.52	100 +	\$37.70	<p style="text-align: center;">10-32 <i>Between-Series</i></p> <p style="text-align: center;">→</p>	 <table border="1"> <thead> <tr> <th colspan="2">PRICE</th> </tr> </thead> <tbody> <tr> <td>1-24</td> <td>\$50.67</td> </tr> <tr> <td>25-49</td> <td>\$47.12</td> </tr> <tr> <td>50-99</td> <td>\$43.58</td> </tr> <tr> <td>100 +</td> <td>\$40.54</td> </tr> </tbody> </table> <p>Model No: PE9751 10-32 Male To BNC Male</p>	PRICE		1-24	\$50.67	25-49	\$47.12	50-99	\$43.58	100 +	\$40.54	 <table border="1"> <thead> <tr> <th colspan="2">PRICE</th> </tr> </thead> <tbody> <tr> <td>1-24</td> <td>\$50.67</td> </tr> <tr> <td>25-49</td> <td>\$47.12</td> </tr> <tr> <td>50-99</td> <td>\$43.58</td> </tr> <tr> <td>100 +</td> <td>\$40.54</td> </tr> </tbody> </table> <p>Model No: PE9753 10-32 Male To BNC Female</p>	PRICE		1-24	\$50.67	25-49	\$47.12	50-99	\$43.58	100 +	\$40.54										
	PRICE																																											
1-24	\$47.12																																											
25-49	\$43.82																																											
50-99	\$40.52																																											
100 +	\$37.70																																											
PRICE																																												
1-24	\$50.67																																											
25-49	\$47.12																																											
50-99	\$43.58																																											
100 +	\$40.54																																											
PRICE																																												
1-24	\$50.67																																											
25-49	\$47.12																																											
50-99	\$43.58																																											
100 +	\$40.54																																											











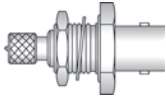
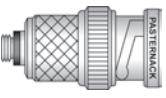
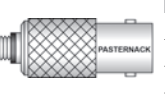

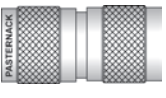

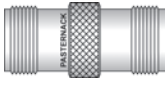
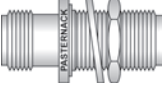
Adapters

See Our Website For Real-Time Stock Availability!

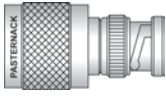
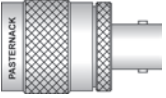
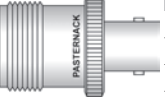
ADAPTERS

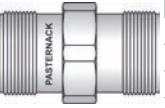
See Adapter Locator on Pages 140-145 or the Adapter Matrix on Pages 138-139

See Page 246 for Mounting Holes

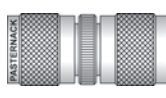
	A	B	C	D																																								
1	 <table border="1"> <thead> <tr> <th colspan="2">PRICE</th> </tr> </thead> <tbody> <tr> <td>1-24</td> <td>\$58.87</td> </tr> <tr> <td>25-49</td> <td>\$54.75</td> </tr> <tr> <td>50-99</td> <td>\$50.63</td> </tr> <tr> <td>100 +</td> <td>\$47.10</td> </tr> </tbody> </table> <p>Model No: PE9755 10-32 Male Bulkhead To BNC Female Mounting Hole B05</p>	PRICE		1-24	\$58.87	25-49	\$54.75	50-99	\$50.63	100 +	\$47.10	 <table border="1"> <thead> <tr> <th colspan="2">PRICE</th> </tr> </thead> <tbody> <tr> <td>1-24</td> <td>\$46.21</td> </tr> <tr> <td>25-49</td> <td>\$42.98</td> </tr> <tr> <td>50-99</td> <td>\$39.74</td> </tr> <tr> <td>100 +</td> <td>\$36.97</td> </tr> </tbody> </table> <p>Model No: PE9750 10-32 Female To BNC Male</p>	PRICE		1-24	\$46.21	25-49	\$42.98	50-99	\$39.74	100 +	\$36.97	 <table border="1"> <thead> <tr> <th colspan="2">PRICE</th> </tr> </thead> <tbody> <tr> <td>1-24</td> <td>\$46.21</td> </tr> <tr> <td>25-49</td> <td>\$42.98</td> </tr> <tr> <td>50-99</td> <td>\$39.74</td> </tr> <tr> <td>100 +</td> <td>\$36.97</td> </tr> </tbody> </table> <p>Model No: PE9752 10-32 Female To BNC Female</p>	PRICE		1-24	\$46.21	25-49	\$42.98	50-99	\$39.74	100 +	\$36.97	 <table border="1"> <thead> <tr> <th colspan="2">PRICE</th> </tr> </thead> <tbody> <tr> <td>1-24</td> <td>\$47.12</td> </tr> <tr> <td>25-49</td> <td>\$43.82</td> </tr> <tr> <td>50-99</td> <td>\$40.52</td> </tr> <tr> <td>100 +</td> <td>\$37.70</td> </tr> </tbody> </table> <p>Model No: PE9754 10-32 Female Bulkhead To BNC Female, Mounting Hole B05</p>	PRICE		1-24	\$47.12	25-49	\$43.82	50-99	\$40.52	100 +	\$37.70
	PRICE																																											
	1-24	\$58.87																																										
	25-49	\$54.75																																										
	50-99	\$50.63																																										
	100 +	\$47.10																																										
PRICE																																												
1-24	\$46.21																																											
25-49	\$42.98																																											
50-99	\$39.74																																											
100 +	\$36.97																																											
PRICE																																												
1-24	\$46.21																																											
25-49	\$42.98																																											
50-99	\$39.74																																											
100 +	\$36.97																																											
PRICE																																												
1-24	\$47.12																																											
25-49	\$43.82																																											
50-99	\$40.52																																											
100 +	\$37.70																																											
2	SC In-Series 																																											
	 <table border="1"> <thead> <tr> <th colspan="2">PRICE</th> </tr> </thead> <tbody> <tr> <td>1-24</td> <td>\$82.33</td> </tr> <tr> <td>25-49</td> <td>\$76.57</td> </tr> <tr> <td>50-99</td> <td>\$70.80</td> </tr> <tr> <td>100 +</td> <td>\$65.86</td> </tr> </tbody> </table> <p>Model No: PE9403 SC Male To SC Male</p>	PRICE		1-24	\$82.33	25-49	\$76.57	50-99	\$70.80	100 +	\$65.86	 <table border="1"> <thead> <tr> <th colspan="2">PRICE</th> </tr> </thead> <tbody> <tr> <td>1-24</td> <td>\$82.33</td> </tr> <tr> <td>25-49</td> <td>\$76.57</td> </tr> <tr> <td>50-99</td> <td>\$70.80</td> </tr> <tr> <td>100 +</td> <td>\$65.86</td> </tr> </tbody> </table> <p>Model No: PE9572 SC Male To SC Female</p>	PRICE		1-24	\$82.33	25-49	\$76.57	50-99	\$70.80	100 +	\$65.86	 <table border="1"> <thead> <tr> <th colspan="2">PRICE</th> </tr> </thead> <tbody> <tr> <td>1-24</td> <td>\$115.67</td> </tr> <tr> <td>25-49</td> <td>\$107.57</td> </tr> <tr> <td>50-99</td> <td>\$99.48</td> </tr> <tr> <td>100 +</td> <td>\$92.54</td> </tr> </tbody> </table> <p>Model No: PE9405 SC Male To SC Female Right Angle</p>	PRICE		1-24	\$115.67	25-49	\$107.57	50-99	\$99.48	100 +	\$92.54											
	PRICE																																											
1-24	\$82.33																																											
25-49	\$76.57																																											
50-99	\$70.80																																											
100 +	\$65.86																																											
PRICE																																												
1-24	\$82.33																																											
25-49	\$76.57																																											
50-99	\$70.80																																											
100 +	\$65.86																																											
PRICE																																												
1-24	\$115.67																																											
25-49	\$107.57																																											
50-99	\$99.48																																											
100 +	\$92.54																																											
 <table border="1"> <thead> <tr> <th colspan="2">PRICE</th> </tr> </thead> <tbody> <tr> <td>1-24</td> <td>\$80.96</td> </tr> <tr> <td>25-49</td> <td>\$75.29</td> </tr> <tr> <td>50-99</td> <td>\$69.63</td> </tr> <tr> <td>100 +</td> <td>\$64.77</td> </tr> </tbody> </table> <p>Model No: PE9404 SC Female To SC Female</p>	PRICE		1-24	\$80.96	25-49	\$75.29	50-99	\$69.63	100 +	\$64.77	 <table border="1"> <thead> <tr> <th colspan="2">PRICE</th> </tr> </thead> <tbody> <tr> <td>1-24</td> <td>\$104.12</td> </tr> <tr> <td>25-49</td> <td>\$96.83</td> </tr> <tr> <td>50-99</td> <td>\$89.54</td> </tr> <tr> <td>100 +</td> <td>\$83.30</td> </tr> </tbody> </table> <p>Model No: PE9573 SC Female To SC Female Bulkhead Mounting Hole B11</p>	PRICE		1-24	\$104.12	25-49	\$96.83	50-99	\$89.54	100 +	\$83.30	 <table border="1"> <thead> <tr> <th colspan="2">PRICE</th> </tr> </thead> <tbody> <tr> <td>1-24</td> <td>\$211.93</td> </tr> <tr> <td>25-49</td> <td>\$197.09</td> </tr> <tr> <td>50-99</td> <td>\$182.26</td> </tr> <tr> <td>100 +</td> <td>\$169.54</td> </tr> </tbody> </table> <p>Model No: PE9225 SC "T" Female-Male-Female</p>	PRICE		1-24	\$211.93	25-49	\$197.09	50-99	\$182.26	100 +	\$169.54	SC Between-Series 											
PRICE																																												
1-24	\$80.96																																											
25-49	\$75.29																																											
50-99	\$69.63																																											
100 +	\$64.77																																											
PRICE																																												
1-24	\$104.12																																											
25-49	\$96.83																																											
50-99	\$89.54																																											
100 +	\$83.30																																											
PRICE																																												
1-24	\$211.93																																											
25-49	\$197.09																																											
50-99	\$182.26																																											
100 +	\$169.54																																											
4	LC In-Series 																																											
	 <table border="1"> <thead> <tr> <th colspan="2">PRICE</th> </tr> </thead> <tbody> <tr> <td>1-24</td> <td>\$82.33</td> </tr> <tr> <td>25-49</td> <td>\$76.57</td> </tr> <tr> <td>50-99</td> <td>\$70.80</td> </tr> <tr> <td>100 +</td> <td>\$65.86</td> </tr> </tbody> </table> <p>Model No: PE9568 SC Male To BNC Male</p>	PRICE		1-24	\$82.33	25-49	\$76.57	50-99	\$70.80	100 +	\$65.86	 <table border="1"> <thead> <tr> <th colspan="2">PRICE</th> </tr> </thead> <tbody> <tr> <td>1-24</td> <td>\$105.43</td> </tr> <tr> <td>25-49</td> <td>\$98.05</td> </tr> <tr> <td>50-99</td> <td>\$90.67</td> </tr> <tr> <td>100 +</td> <td>\$84.34</td> </tr> </tbody> </table> <p>Model No: PE9200 SC Male To BNC Female</p>	PRICE		1-24	\$105.43	25-49	\$98.05	50-99	\$90.67	100 +	\$84.34	 <table border="1"> <thead> <tr> <th colspan="2">PRICE</th> </tr> </thead> <tbody> <tr> <td>1-24</td> <td>\$82.33</td> </tr> <tr> <td>25-49</td> <td>\$76.57</td> </tr> <tr> <td>50-99</td> <td>\$70.80</td> </tr> <tr> <td>100 +</td> <td>\$65.86</td> </tr> </tbody> </table> <p>Model No: PE9571 SC Female To BNC Female</p>	PRICE		1-24	\$82.33	25-49	\$76.57	50-99	\$70.80	100 +	\$65.86											
	PRICE																																											
1-24	\$82.33																																											
25-49	\$76.57																																											
50-99	\$70.80																																											
100 +	\$65.86																																											
PRICE																																												
1-24	\$105.43																																											
25-49	\$98.05																																											
50-99	\$90.67																																											
100 +	\$84.34																																											
PRICE																																												
1-24	\$82.33																																											
25-49	\$76.57																																											
50-99	\$70.80																																											
100 +	\$65.86																																											
 <table border="1"> <thead> <tr> <th colspan="2">PRICE</th> </tr> </thead> <tbody> <tr> <td>1-24</td> <td>\$196.78</td> </tr> <tr> <td>25-49</td> <td>\$183.01</td> </tr> <tr> <td>50-99</td> <td>\$169.23</td> </tr> <tr> <td>100 +</td> <td>\$157.42</td> </tr> </tbody> </table> <p>Model No: PE9569 LC Male To LC Male</p>	PRICE		1-24	\$196.78	25-49	\$183.01	50-99	\$169.23	100 +	\$157.42	 <table border="1"> <thead> <tr> <th colspan="2">PRICE</th> </tr> </thead> <tbody> <tr> <td>1-24</td> <td>\$300.95</td> </tr> <tr> <td>25-49</td> <td>\$279.88</td> </tr> <tr> <td>50-99</td> <td>\$258.82</td> </tr> <tr> <td>100 +</td> <td>\$240.76</td> </tr> </tbody> </table> <p>Model No: PE9398 LC Male To LC Female Right Angle</p>	PRICE		1-24	\$300.95	25-49	\$279.88	50-99	\$258.82	100 +	\$240.76	 <table border="1"> <thead> <tr> <th colspan="2">PRICE</th> </tr> </thead> <tbody> <tr> <td>1-24</td> <td>\$168.92</td> </tr> <tr> <td>25-49</td> <td>\$157.10</td> </tr> <tr> <td>50-99</td> <td>\$145.27</td> </tr> <tr> <td>100 +</td> <td>\$135.14</td> </tr> </tbody> </table> <p>Model No: PE9419 LC Female To LC Female</p>	PRICE		1-24	\$168.92	25-49	\$157.10	50-99	\$145.27	100 +	\$135.14	LC Between-Series 											
PRICE																																												
1-24	\$196.78																																											
25-49	\$183.01																																											
50-99	\$169.23																																											
100 +	\$157.42																																											
PRICE																																												
1-24	\$300.95																																											
25-49	\$279.88																																											
50-99	\$258.82																																											
100 +	\$240.76																																											
PRICE																																												
1-24	\$168.92																																											
25-49	\$157.10																																											
50-99	\$145.27																																											
100 +	\$135.14																																											
6	HN In-Series 																																											
	 <table border="1"> <thead> <tr> <th colspan="2">PRICE</th> </tr> </thead> <tbody> <tr> <td>1-24</td> <td>\$235.14</td> </tr> <tr> <td>25-49</td> <td>\$218.68</td> </tr> <tr> <td>50-99</td> <td>\$202.22</td> </tr> <tr> <td>100 +</td> <td>\$188.11</td> </tr> </tbody> </table> <p>Model No: PE9181 LC Male To HN Female</p>	PRICE		1-24	\$235.14	25-49	\$218.68	50-99	\$202.22	100 +	\$188.11	 <table border="1"> <thead> <tr> <th colspan="2">PRICE</th> </tr> </thead> <tbody> <tr> <td>1-24</td> <td>\$179.00</td> </tr> <tr> <td>25-49</td> <td>\$166.47</td> </tr> <tr> <td>50-99</td> <td>\$153.94</td> </tr> <tr> <td>100 +</td> <td>\$143.20</td> </tr> </tbody> </table> <p>Model No: PE9413 LC Female To HN Male</p>	PRICE		1-24	\$179.00	25-49	\$166.47	50-99	\$153.94	100 +	\$143.20	 <table border="1"> <thead> <tr> <th colspan="2">PRICE</th> </tr> </thead> <tbody> <tr> <td>1-24</td> <td>\$42.25</td> </tr> <tr> <td>25-49</td> <td>\$39.29</td> </tr> <tr> <td>50-99</td> <td>\$36.34</td> </tr> <tr> <td>100 +</td> <td>\$33.80</td> </tr> </tbody> </table> <p>Model No: PE9210 HN Male To HN Male</p>	PRICE		1-24	\$42.25	25-49	\$39.29	50-99	\$36.34	100 +	\$33.80											
	PRICE																																											
1-24	\$235.14																																											
25-49	\$218.68																																											
50-99	\$202.22																																											
100 +	\$188.11																																											
PRICE																																												
1-24	\$179.00																																											
25-49	\$166.47																																											
50-99	\$153.94																																											
100 +	\$143.20																																											
PRICE																																												
1-24	\$42.25																																											
25-49	\$39.29																																											
50-99	\$36.34																																											
100 +	\$33.80																																											











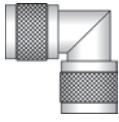



Adapters

See Our Website For Real-Time Stock Availability!

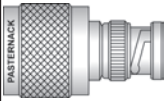
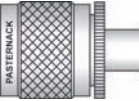
ADAPTERS

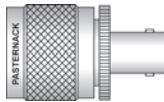
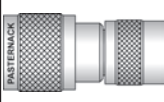
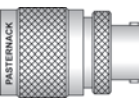
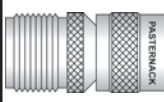
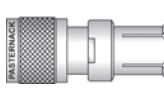
See Adapter Locator on Pages 140-145 or the Adapter Matrix on Pages 138-139

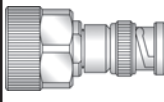
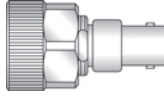
See Page 246 for Mounting Holes

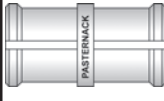
	A	B	C	D																																								
1	 <table border="1"> <thead> <tr> <th colspan="2">PRICE</th> </tr> </thead> <tbody> <tr> <td>1-24</td> <td>\$86.23</td> </tr> <tr> <td>25-49</td> <td>\$80.19</td> </tr> <tr> <td>50-99</td> <td>\$74.16</td> </tr> <tr> <td>100 +</td> <td>\$68.98</td> </tr> </tbody> </table> <p>Model No: PE9577 HN Male To HN Male Right Angle</p>	PRICE		1-24	\$86.23	25-49	\$80.19	50-99	\$74.16	100 +	\$68.98	 <table border="1"> <thead> <tr> <th colspan="2">PRICE</th> </tr> </thead> <tbody> <tr> <td>1-24</td> <td>\$70.68</td> </tr> <tr> <td>25-49</td> <td>\$65.73</td> </tr> <tr> <td>50-99</td> <td>\$60.78</td> </tr> <tr> <td>100 +</td> <td>\$56.54</td> </tr> </tbody> </table> <p>Model No: PE9576 HN Male To HN Female</p>	PRICE		1-24	\$70.68	25-49	\$65.73	50-99	\$60.78	100 +	\$56.54	 <table border="1"> <thead> <tr> <th colspan="2">PRICE</th> </tr> </thead> <tbody> <tr> <td>1-24</td> <td>\$49.25</td> </tr> <tr> <td>25-49</td> <td>\$45.80</td> </tr> <tr> <td>50-99</td> <td>\$42.36</td> </tr> <tr> <td>100 +</td> <td>\$39.40</td> </tr> </tbody> </table> <p>Model No: PE9205 HN Male To HN Female Right Angle</p>	PRICE		1-24	\$49.25	25-49	\$45.80	50-99	\$42.36	100 +	\$39.40	 <table border="1"> <thead> <tr> <th colspan="2">PRICE</th> </tr> </thead> <tbody> <tr> <td>1-24</td> <td>\$40.43</td> </tr> <tr> <td>25-49</td> <td>\$37.60</td> </tr> <tr> <td>50-99</td> <td>\$34.77</td> </tr> <tr> <td>100 +</td> <td>\$32.34</td> </tr> </tbody> </table> <p>Model No: PE9580 HN Female To HN Female</p>	PRICE		1-24	\$40.43	25-49	\$37.60	50-99	\$34.77	100 +	\$32.34
	PRICE																																											
1-24	\$86.23																																											
25-49	\$80.19																																											
50-99	\$74.16																																											
100 +	\$68.98																																											
PRICE																																												
1-24	\$70.68																																											
25-49	\$65.73																																											
50-99	\$60.78																																											
100 +	\$56.54																																											
PRICE																																												
1-24	\$49.25																																											
25-49	\$45.80																																											
50-99	\$42.36																																											
100 +	\$39.40																																											
PRICE																																												
1-24	\$40.43																																											
25-49	\$37.60																																											
50-99	\$34.77																																											
100 +	\$32.34																																											
2	 <table border="1"> <thead> <tr> <th colspan="2">PRICE</th> </tr> </thead> <tbody> <tr> <td>1-24</td> <td>\$47.83</td> </tr> <tr> <td>25-49</td> <td>\$44.48</td> </tr> <tr> <td>50-99</td> <td>\$41.13</td> </tr> <tr> <td>100 +</td> <td>\$38.26</td> </tr> </tbody> </table> <p>Model No: PE9193 HN Female To HN Female Bulkhead Mounting Hole G03</p>	PRICE		1-24	\$47.83	25-49	\$44.48	50-99	\$41.13	100 +	\$38.26	 <table border="1"> <thead> <tr> <th colspan="2">PRICE</th> </tr> </thead> <tbody> <tr> <td>1-24</td> <td>\$94.08</td> </tr> <tr> <td>25-49</td> <td>\$87.49</td> </tr> <tr> <td>50-99</td> <td>\$80.91</td> </tr> <tr> <td>100 +</td> <td>\$75.26</td> </tr> </tbody> </table> <p>Model No: PE9578 HN "T" Male-Female-Male</p>	PRICE		1-24	\$94.08	25-49	\$87.49	50-99	\$80.91	100 +	\$75.26	 <table border="1"> <thead> <tr> <th colspan="2">PRICE</th> </tr> </thead> <tbody> <tr> <td>1-24</td> <td>\$94.08</td> </tr> <tr> <td>25-49</td> <td>\$87.49</td> </tr> <tr> <td>50-99</td> <td>\$80.91</td> </tr> <tr> <td>100 +</td> <td>\$75.26</td> </tr> </tbody> </table> <p>Model No: PE9575 HN "T" Female-Male-Female</p>	PRICE		1-24	\$94.08	25-49	\$87.49	50-99	\$80.91	100 +	\$75.26	 <table border="1"> <thead> <tr> <th colspan="2">PRICE</th> </tr> </thead> <tbody> <tr> <td>1-24</td> <td>\$94.08</td> </tr> <tr> <td>25-49</td> <td>\$87.49</td> </tr> <tr> <td>50-99</td> <td>\$80.91</td> </tr> <tr> <td>100 +</td> <td>\$75.26</td> </tr> </tbody> </table> <p>Model No: PE9574 HN "T" Female-Female-Female</p>	PRICE		1-24	\$94.08	25-49	\$87.49	50-99	\$80.91	100 +	\$75.26
	PRICE																																											
1-24	\$47.83																																											
25-49	\$44.48																																											
50-99	\$41.13																																											
100 +	\$38.26																																											
PRICE																																												
1-24	\$94.08																																											
25-49	\$87.49																																											
50-99	\$80.91																																											
100 +	\$75.26																																											
PRICE																																												
1-24	\$94.08																																											
25-49	\$87.49																																											
50-99	\$80.91																																											
100 +	\$75.26																																											
PRICE																																												
1-24	\$94.08																																											
25-49	\$87.49																																											
50-99	\$80.91																																											
100 +	\$75.26																																											
3	<p style="text-align: center;">HN <i>Between-Series</i></p> <p style="text-align: center;">→</p>	 <table border="1"> <thead> <tr> <th colspan="2">PRICE</th> </tr> </thead> <tbody> <tr> <td>1-24</td> <td>\$59.02</td> </tr> <tr> <td>25-49</td> <td>\$54.89</td> </tr> <tr> <td>50-99</td> <td>\$50.76</td> </tr> <tr> <td>100 +</td> <td>\$47.22</td> </tr> </tbody> </table> <p>Model No: PE9567 HN Male To BNC Male</p>	PRICE		1-24	\$59.02	25-49	\$54.89	50-99	\$50.76	100 +	\$47.22	 <table border="1"> <thead> <tr> <th colspan="2">PRICE</th> </tr> </thead> <tbody> <tr> <td>1-24</td> <td>\$45.35</td> </tr> <tr> <td>25-49</td> <td>\$42.18</td> </tr> <tr> <td>50-99</td> <td>\$39.00</td> </tr> <tr> <td>100 +</td> <td>\$36.28</td> </tr> </tbody> </table> <p>Model No: PE9126 HN Male To BNC Female</p>	PRICE		1-24	\$45.35	25-49	\$42.18	50-99	\$39.00	100 +	\$36.28	 <table border="1"> <thead> <tr> <th colspan="2">PRICE</th> </tr> </thead> <tbody> <tr> <td>1-24</td> <td>\$46.21</td> </tr> <tr> <td>25-49</td> <td>\$42.98</td> </tr> <tr> <td>50-99</td> <td>\$39.74</td> </tr> <tr> <td>100 +</td> <td>\$36.97</td> </tr> </tbody> </table> <p>Model No: PE9129 HN Female To BNC Male</p>	PRICE		1-24	\$46.21	25-49	\$42.98	50-99	\$39.74	100 +	\$36.97										
	PRICE																																											
1-24	\$59.02																																											
25-49	\$54.89																																											
50-99	\$50.76																																											
100 +	\$47.22																																											
PRICE																																												
1-24	\$45.35																																											
25-49	\$42.18																																											
50-99	\$39.00																																											
100 +	\$36.28																																											
PRICE																																												
1-24	\$46.21																																											
25-49	\$42.98																																											
50-99	\$39.74																																											
100 +	\$36.97																																											
4	 <table border="1"> <thead> <tr> <th colspan="2">PRICE</th> </tr> </thead> <tbody> <tr> <td>1-24</td> <td>\$105.89</td> </tr> <tr> <td>25-49</td> <td>\$98.48</td> </tr> <tr> <td>50-99</td> <td>\$91.07</td> </tr> <tr> <td>100 +</td> <td>\$84.71</td> </tr> </tbody> </table> <p>Model No: PE9264 HN Male To MHV Female</p>	PRICE		1-24	\$105.89	25-49	\$98.48	50-99	\$91.07	100 +	\$84.71	 <table border="1"> <thead> <tr> <th colspan="2">PRICE</th> </tr> </thead> <tbody> <tr> <td>1-24</td> <td>\$70.68</td> </tr> <tr> <td>25-49</td> <td>\$65.73</td> </tr> <tr> <td>50-99</td> <td>\$60.78</td> </tr> <tr> <td>100 +</td> <td>\$56.54</td> </tr> </tbody> </table> <p>Model No: PE9579 HN Male To C Male</p>	PRICE		1-24	\$70.68	25-49	\$65.73	50-99	\$60.78	100 +	\$56.54	 <table border="1"> <thead> <tr> <th colspan="2">PRICE</th> </tr> </thead> <tbody> <tr> <td>1-24</td> <td>\$48.94</td> </tr> <tr> <td>25-49</td> <td>\$45.51</td> </tr> <tr> <td>50-99</td> <td>\$42.09</td> </tr> <tr> <td>100 +</td> <td>\$39.15</td> </tr> </tbody> </table> <p>Model No: PE9296 HN Male To C Female</p>	PRICE		1-24	\$48.94	25-49	\$45.51	50-99	\$42.09	100 +	\$39.15	 <table border="1"> <thead> <tr> <th colspan="2">PRICE</th> </tr> </thead> <tbody> <tr> <td>1-24</td> <td>\$70.68</td> </tr> <tr> <td>25-49</td> <td>\$65.73</td> </tr> <tr> <td>50-99</td> <td>\$60.78</td> </tr> <tr> <td>100 +</td> <td>\$56.54</td> </tr> </tbody> </table> <p>Model No: PE9212 HN Female To C Male</p>	PRICE		1-24	\$70.68	25-49	\$65.73	50-99	\$60.78	100 +	\$56.54
	PRICE																																											
1-24	\$105.89																																											
25-49	\$98.48																																											
50-99	\$91.07																																											
100 +	\$84.71																																											
PRICE																																												
1-24	\$70.68																																											
25-49	\$65.73																																											
50-99	\$60.78																																											
100 +	\$56.54																																											
PRICE																																												
1-24	\$48.94																																											
25-49	\$45.51																																											
50-99	\$42.09																																											
100 +	\$39.15																																											
PRICE																																												
1-24	\$70.68																																											
25-49	\$65.73																																											
50-99	\$60.78																																											
100 +	\$56.54																																											
5	 <table border="1"> <thead> <tr> <th colspan="2">PRICE</th> </tr> </thead> <tbody> <tr> <td>1-24</td> <td>\$168.51</td> </tr> <tr> <td>25-49</td> <td>\$156.71</td> </tr> <tr> <td>50-99</td> <td>\$144.92</td> </tr> <tr> <td>100 +</td> <td>\$134.81</td> </tr> </tbody> </table> <p>Model No: PE9386 HN Male To GR874</p>	PRICE		1-24	\$168.51	25-49	\$156.71	50-99	\$144.92	100 +	\$134.81	 <table border="1"> <thead> <tr> <th colspan="2">PRICE</th> </tr> </thead> <tbody> <tr> <td>1-24</td> <td>\$168.51</td> </tr> <tr> <td>25-49</td> <td>\$156.71</td> </tr> <tr> <td>50-99</td> <td>\$144.92</td> </tr> <tr> <td>100 +</td> <td>\$134.81</td> </tr> </tbody> </table> <p>Model No: PE9387 HN Female To GR874</p>	PRICE		1-24	\$168.51	25-49	\$156.71	50-99	\$144.92	100 +	\$134.81	<p style="text-align: center;">7mm <i>Between-Series</i></p> <p style="text-align: center;">→</p>	 <table border="1"> <thead> <tr> <th colspan="2">PRICE</th> </tr> </thead> <tbody> <tr> <td>1-24</td> <td>\$235.44</td> </tr> <tr> <td>25-49</td> <td>\$218.96</td> </tr> <tr> <td>50-99</td> <td>\$202.48</td> </tr> <tr> <td>100 +</td> <td>\$188.35</td> </tr> </tbody> </table> <p>PRECISION Model No: PE9221 7mm To BNC Male Max VSWR 1.15:1 @ 8 GHz</p>	PRICE		1-24	\$235.44	25-49	\$218.96	50-99	\$202.48	100 +	\$188.35										
	PRICE																																											
1-24	\$168.51																																											
25-49	\$156.71																																											
50-99	\$144.92																																											
100 +	\$134.81																																											
PRICE																																												
1-24	\$168.51																																											
25-49	\$156.71																																											
50-99	\$144.92																																											
100 +	\$134.81																																											
PRICE																																												
1-24	\$235.44																																											
25-49	\$218.96																																											
50-99	\$202.48																																											
100 +	\$188.35																																											
6	 <table border="1"> <thead> <tr> <th colspan="2">PRICE</th> </tr> </thead> <tbody> <tr> <td>1-24</td> <td>\$173.63</td> </tr> <tr> <td>25-49</td> <td>\$161.48</td> </tr> <tr> <td>50-99</td> <td>\$149.32</td> </tr> <tr> <td>100 +</td> <td>\$138.90</td> </tr> </tbody> </table> <p>PRECISION Model No: PE9220 7mm To BNC Female Max VSWR 1.15:1 @ 8 GHz</p>	PRICE		1-24	\$173.63	25-49	\$161.48	50-99	\$149.32	100 +	\$138.90	<p style="text-align: center;">SMP <i>In-Series</i></p> <p style="text-align: center;">→</p>	 <table border="1"> <thead> <tr> <th colspan="2">PRICE</th> </tr> </thead> <tbody> <tr> <td>1-24</td> <td>\$43.77</td> </tr> <tr> <td>25-49</td> <td>\$40.71</td> </tr> <tr> <td>50-99</td> <td>\$37.64</td> </tr> <tr> <td>100 +</td> <td>\$35.02</td> </tr> </tbody> </table> <p>NEW Model No: PE91004 SMP Female To SMP Female, 22.4mm Long, Bullet</p>	PRICE		1-24	\$43.77	25-49	\$40.71	50-99	\$37.64	100 +	\$35.02	 <table border="1"> <thead> <tr> <th colspan="2">PRICE</th> </tr> </thead> <tbody> <tr> <td>1-24</td> <td>\$30.10</td> </tr> <tr> <td>25-49</td> <td>\$27.99</td> </tr> <tr> <td>50-99</td> <td>\$25.89</td> </tr> <tr> <td>100 +</td> <td>\$24.08</td> </tr> </tbody> </table> <p>Model No: PE9686 SMP Female To SMP Female</p>	PRICE		1-24	\$30.10	25-49	\$27.99	50-99	\$25.89	100 +	\$24.08										
	PRICE																																											
1-24	\$173.63																																											
25-49	\$161.48																																											
50-99	\$149.32																																											
100 +	\$138.90																																											
PRICE																																												
1-24	\$43.77																																											
25-49	\$40.71																																											
50-99	\$37.64																																											
100 +	\$35.02																																											
PRICE																																												
1-24	\$30.10																																											
25-49	\$27.99																																											
50-99	\$25.89																																											
100 +	\$24.08																																											













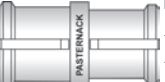



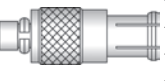

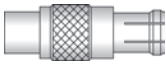
Adapters

See Our Website For Real-Time Stock Availability!

ADAPTERS

See Adapter Locator on Pages 140-145 or the Adapter Matrix on Pages 138-139

See Page 246 for Mounting Holes

	A	B	C	D																																								
1	 <table border="1"> <thead> <tr> <th colspan="2">PRICE</th> </tr> </thead> <tbody> <tr> <td>1-24</td> <td>\$45.09</td> </tr> <tr> <td>25-49</td> <td>\$41.93</td> </tr> <tr> <td>50-99</td> <td>\$38.78</td> </tr> <tr> <td>100 +</td> <td>\$36.07</td> </tr> </tbody> </table> <p>Model No: PE9775 SMP Female To SMP Female, 19.5mm Long, Bullet</p>	PRICE		1-24	\$45.09	25-49	\$41.93	50-99	\$38.78	100 +	\$36.07	 <table border="1"> <thead> <tr> <th colspan="2">PRICE</th> </tr> </thead> <tbody> <tr> <td>1-24</td> <td>\$45.85</td> </tr> <tr> <td>25-49</td> <td>\$42.64</td> </tr> <tr> <td>50-99</td> <td>\$39.43</td> </tr> <tr> <td>100 +</td> <td>\$36.68</td> </tr> </tbody> </table> <p>Model No: PE9776 SMP Female To SMP Female, 12.6mm Long, Bullet</p>	PRICE		1-24	\$45.85	25-49	\$42.64	50-99	\$39.43	100 +	\$36.68	 <table border="1"> <thead> <tr> <th colspan="2">PRICE</th> </tr> </thead> <tbody> <tr> <td>1-24</td> <td>\$35.26</td> </tr> <tr> <td>25-49</td> <td>\$32.79</td> </tr> <tr> <td>50-99</td> <td>\$30.32</td> </tr> <tr> <td>100 +</td> <td>\$28.21</td> </tr> </tbody> </table> <p>Model No: PE9777 SMP Female To SMP Female 6.45mm Long, Bullet</p>	PRICE		1-24	\$35.26	25-49	\$32.79	50-99	\$30.32	100 +	\$28.21	<p>Mini SMP In-Series</p> <p>→</p>										
PRICE																																												
1-24	\$45.09																																											
25-49	\$41.93																																											
50-99	\$38.78																																											
100 +	\$36.07																																											
PRICE																																												
1-24	\$45.85																																											
25-49	\$42.64																																											
50-99	\$39.43																																											
100 +	\$36.68																																											
PRICE																																												
1-24	\$35.26																																											
25-49	\$32.79																																											
50-99	\$30.32																																											
100 +	\$28.21																																											
2	 <table border="1"> <thead> <tr> <th colspan="2">PRICE</th> </tr> </thead> <tbody> <tr> <td>1-24</td> <td>\$34.71</td> </tr> <tr> <td>25-49</td> <td>\$32.28</td> </tr> <tr> <td>50-99</td> <td>\$29.85</td> </tr> <tr> <td>100 +</td> <td>\$27.77</td> </tr> </tbody> </table> <p>Model No: PE9780 Mini SMP Female To Mini SMP Female 5.3mm Long, 65 GHz, Bullet</p>	PRICE		1-24	\$34.71	25-49	\$32.28	50-99	\$29.85	100 +	\$27.77	<p>MMCX In-Series</p> <p>→</p>	 <table border="1"> <thead> <tr> <th colspan="2">PRICE</th> </tr> </thead> <tbody> <tr> <td>1-24</td> <td>\$47.12</td> </tr> <tr> <td>25-49</td> <td>\$43.82</td> </tr> <tr> <td>50-99</td> <td>\$40.52</td> </tr> <tr> <td>100 +</td> <td>\$37.70</td> </tr> </tbody> </table> <p>Model No: PE9480 MMCX Plug To MMCX Jack</p>	PRICE		1-24	\$47.12	25-49	\$43.82	50-99	\$40.52	100 +	\$37.70	 <table border="1"> <thead> <tr> <th colspan="2">PRICE</th> </tr> </thead> <tbody> <tr> <td>1-24</td> <td>\$48.33</td> </tr> <tr> <td>25-49</td> <td>\$44.95</td> </tr> <tr> <td>50-99</td> <td>\$41.56</td> </tr> <tr> <td>100 +</td> <td>\$38.66</td> </tr> </tbody> </table> <p>Model No: PE9523 MMCX Jack To MMCX Jack</p>	PRICE		1-24	\$48.33	25-49	\$44.95	50-99	\$41.56	100 +	\$38.66										
PRICE																																												
1-24	\$34.71																																											
25-49	\$32.28																																											
50-99	\$29.85																																											
100 +	\$27.77																																											
PRICE																																												
1-24	\$47.12																																											
25-49	\$43.82																																											
50-99	\$40.52																																											
100 +	\$37.70																																											
PRICE																																												
1-24	\$48.33																																											
25-49	\$44.95																																											
50-99	\$41.56																																											
100 +	\$38.66																																											
3	 <table border="1"> <thead> <tr> <th colspan="2">PRICE</th> </tr> </thead> <tbody> <tr> <td>1-24</td> <td>\$52.03</td> </tr> <tr> <td>25-49</td> <td>\$48.39</td> </tr> <tr> <td>50-99</td> <td>\$44.75</td> </tr> <tr> <td>100 +</td> <td>\$41.62</td> </tr> </tbody> </table> <p>Model No: PE9522 MMCX Jack To MMCX Jack Bulkhead Mounting Hole B01</p>	PRICE		1-24	\$52.03	25-49	\$48.39	50-99	\$44.75	100 +	\$41.62	<p>MMCX Between-Series</p> <p>→</p>	 <table border="1"> <thead> <tr> <th colspan="2">PRICE</th> </tr> </thead> <tbody> <tr> <td>1-24</td> <td>\$58.87</td> </tr> <tr> <td>25-49</td> <td>\$54.75</td> </tr> <tr> <td>50-99</td> <td>\$50.63</td> </tr> <tr> <td>100 +</td> <td>\$47.10</td> </tr> </tbody> </table> <p>Model No: PE9527 MMCX Plug To MCX Plug</p>	PRICE		1-24	\$58.87	25-49	\$54.75	50-99	\$50.63	100 +	\$47.10	 <table border="1"> <thead> <tr> <th colspan="2">PRICE</th> </tr> </thead> <tbody> <tr> <td>1-24</td> <td>\$58.87</td> </tr> <tr> <td>25-49</td> <td>\$54.75</td> </tr> <tr> <td>50-99</td> <td>\$50.63</td> </tr> <tr> <td>100 +</td> <td>\$47.10</td> </tr> </tbody> </table> <p>Model No: PE9525 MMCX Plug To MCX Jack</p>	PRICE		1-24	\$58.87	25-49	\$54.75	50-99	\$50.63	100 +	\$47.10										
PRICE																																												
1-24	\$52.03																																											
25-49	\$48.39																																											
50-99	\$44.75																																											
100 +	\$41.62																																											
PRICE																																												
1-24	\$58.87																																											
25-49	\$54.75																																											
50-99	\$50.63																																											
100 +	\$47.10																																											
PRICE																																												
1-24	\$58.87																																											
25-49	\$54.75																																											
50-99	\$50.63																																											
100 +	\$47.10																																											
4	 <table border="1"> <thead> <tr> <th colspan="2">PRICE</th> </tr> </thead> <tbody> <tr> <td>1-24</td> <td>\$58.87</td> </tr> <tr> <td>25-49</td> <td>\$54.75</td> </tr> <tr> <td>50-99</td> <td>\$50.63</td> </tr> <tr> <td>100 +</td> <td>\$47.10</td> </tr> </tbody> </table> <p>Model No: PE9528 MMCX Jack To MCX Plug</p>	PRICE		1-24	\$58.87	25-49	\$54.75	50-99	\$50.63	100 +	\$47.10	 <table border="1"> <thead> <tr> <th colspan="2">PRICE</th> </tr> </thead> <tbody> <tr> <td>1-24</td> <td>\$58.87</td> </tr> <tr> <td>25-49</td> <td>\$54.75</td> </tr> <tr> <td>50-99</td> <td>\$50.63</td> </tr> <tr> <td>100 +</td> <td>\$47.10</td> </tr> </tbody> </table> <p>Model No: PE9526 MMCX Jack To MCX Jack</p>	PRICE		1-24	\$58.87	25-49	\$54.75	50-99	\$50.63	100 +	\$47.10	 <table border="1"> <thead> <tr> <th colspan="2">PRICE</th> </tr> </thead> <tbody> <tr> <td>1-24</td> <td>\$64.70</td> </tr> <tr> <td>25-49</td> <td>\$60.17</td> </tr> <tr> <td>50-99</td> <td>\$55.64</td> </tr> <tr> <td>100 +</td> <td>\$51.76</td> </tr> </tbody> </table> <p>Model No: PE9517 MMCX Plug To BNC Male</p>	PRICE		1-24	\$64.70	25-49	\$60.17	50-99	\$55.64	100 +	\$51.76	 <table border="1"> <thead> <tr> <th colspan="2">PRICE</th> </tr> </thead> <tbody> <tr> <td>1-24</td> <td>\$71.94</td> </tr> <tr> <td>25-49</td> <td>\$66.90</td> </tr> <tr> <td>50-99</td> <td>\$61.87</td> </tr> <tr> <td>100 +</td> <td>\$57.55</td> </tr> </tbody> </table> <p>Model No: PE9519 MMCX Plug To BNC Female</p>	PRICE		1-24	\$71.94	25-49	\$66.90	50-99	\$61.87	100 +	\$57.55
PRICE																																												
1-24	\$58.87																																											
25-49	\$54.75																																											
50-99	\$50.63																																											
100 +	\$47.10																																											
PRICE																																												
1-24	\$58.87																																											
25-49	\$54.75																																											
50-99	\$50.63																																											
100 +	\$47.10																																											
PRICE																																												
1-24	\$64.70																																											
25-49	\$60.17																																											
50-99	\$55.64																																											
100 +	\$51.76																																											
PRICE																																												
1-24	\$71.94																																											
25-49	\$66.90																																											
50-99	\$61.87																																											
100 +	\$57.55																																											
5	 <table border="1"> <thead> <tr> <th colspan="2">PRICE</th> </tr> </thead> <tbody> <tr> <td>1-24</td> <td>\$64.70</td> </tr> <tr> <td>25-49</td> <td>\$60.17</td> </tr> <tr> <td>50-99</td> <td>\$55.64</td> </tr> <tr> <td>100 +</td> <td>\$51.76</td> </tr> </tbody> </table> <p>Model No: PE9518 MMCX Jack To BNC Male</p>	PRICE		1-24	\$64.70	25-49	\$60.17	50-99	\$55.64	100 +	\$51.76	 <table border="1"> <thead> <tr> <th colspan="2">PRICE</th> </tr> </thead> <tbody> <tr> <td>1-24</td> <td>\$64.70</td> </tr> <tr> <td>25-49</td> <td>\$60.17</td> </tr> <tr> <td>50-99</td> <td>\$55.64</td> </tr> <tr> <td>100 +</td> <td>\$51.76</td> </tr> </tbody> </table> <p>Model No: PE9516 MMCX Jack To BNC Female</p>	PRICE		1-24	\$64.70	25-49	\$60.17	50-99	\$55.64	100 +	\$51.76	<p>MCX In-Series</p> <p>→</p>	 <table border="1"> <thead> <tr> <th colspan="2">PRICE</th> </tr> </thead> <tbody> <tr> <td>1-24</td> <td>\$47.12</td> </tr> <tr> <td>25-49</td> <td>\$43.82</td> </tr> <tr> <td>50-99</td> <td>\$40.52</td> </tr> <tr> <td>100 +</td> <td>\$37.70</td> </tr> </tbody> </table> <p>Model No: PE9479 MCX Plug To MCX Jack</p>	PRICE		1-24	\$47.12	25-49	\$43.82	50-99	\$40.52	100 +	\$37.70										
PRICE																																												
1-24	\$64.70																																											
25-49	\$60.17																																											
50-99	\$55.64																																											
100 +	\$51.76																																											
PRICE																																												
1-24	\$64.70																																											
25-49	\$60.17																																											
50-99	\$55.64																																											
100 +	\$51.76																																											
PRICE																																												
1-24	\$47.12																																											
25-49	\$43.82																																											
50-99	\$40.52																																											
100 +	\$37.70																																											
6	 <table border="1"> <thead> <tr> <th colspan="2">PRICE</th> </tr> </thead> <tbody> <tr> <td>1-24</td> <td>\$11.70</td> </tr> <tr> <td>25-49</td> <td>\$10.88</td> </tr> <tr> <td>50-99</td> <td>\$10.06</td> </tr> <tr> <td>100 +</td> <td>\$9.36</td> </tr> </tbody> </table> <p>Model No: PE9524 MCX Jack To MCX Jack</p>	PRICE		1-24	\$11.70	25-49	\$10.88	50-99	\$10.06	100 +	\$9.36	 <table border="1"> <thead> <tr> <th colspan="2">PRICE</th> </tr> </thead> <tbody> <tr> <td>1-24</td> <td>\$15.05</td> </tr> <tr> <td>25-49</td> <td>\$14.00</td> </tr> <tr> <td>50-99</td> <td>\$12.94</td> </tr> <tr> <td>100 +</td> <td>\$12.04</td> </tr> </tbody> </table> <p>Model No: PE9474 MCX Jack To MCX Jack Bulkhead Mounting Hole B01</p>	PRICE		1-24	\$15.05	25-49	\$14.00	50-99	\$12.94	100 +	\$12.04	<p>MCX Between-Series</p> <p>→</p>	 <table border="1"> <thead> <tr> <th colspan="2">PRICE</th> </tr> </thead> <tbody> <tr> <td>1-24</td> <td>\$46.71</td> </tr> <tr> <td>25-49</td> <td>\$43.44</td> </tr> <tr> <td>50-99</td> <td>\$40.17</td> </tr> <tr> <td>100 +</td> <td>\$37.37</td> </tr> </tbody> </table> <p>Model No: PE9469 MCX Plug To BNC Male</p>	PRICE		1-24	\$46.71	25-49	\$43.44	50-99	\$40.17	100 +	\$37.37										
PRICE																																												
1-24	\$11.70																																											
25-49	\$10.88																																											
50-99	\$10.06																																											
100 +	\$9.36																																											
PRICE																																												
1-24	\$15.05																																											
25-49	\$14.00																																											
50-99	\$12.94																																											
100 +	\$12.04																																											
PRICE																																												
1-24	\$46.71																																											
25-49	\$43.44																																											
50-99	\$40.17																																											
100 +	\$37.37																																											







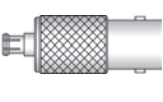
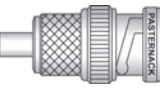
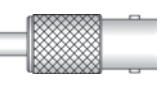
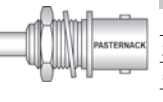
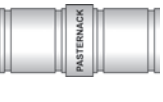
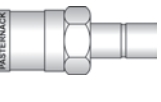
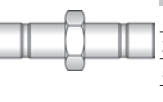
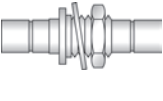

Adapters

See Our Website For Real-Time Stock Availability!

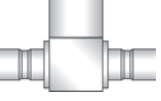
ADAPTERS

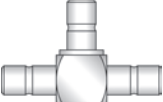
See Adapter Locator on Pages 140-145 or the Adapter Matrix on Pages 138-139

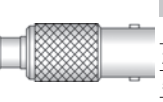
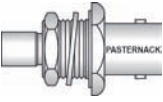
See Page 246 for Mounting Holes

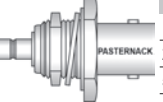
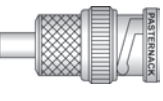
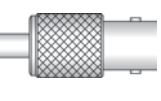
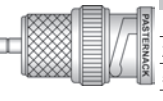
	A	B	C	D																																								
1	 <table border="1"> <thead> <tr> <th colspan="2">PRICE</th> </tr> </thead> <tbody> <tr> <td>1-24</td> <td>\$57.81</td> </tr> <tr> <td>25-49</td> <td>\$53.76</td> </tr> <tr> <td>50-99</td> <td>\$49.72</td> </tr> <tr> <td>100 +</td> <td>\$46.25</td> </tr> </tbody> </table> <p>Model No: PE9467 MCX Plug To BNC Female</p>	PRICE		1-24	\$57.81	25-49	\$53.76	50-99	\$49.72	100 +	\$46.25	 <table border="1"> <thead> <tr> <th colspan="2">PRICE</th> </tr> </thead> <tbody> <tr> <td>1-24</td> <td>\$52.03</td> </tr> <tr> <td>25-49</td> <td>\$48.39</td> </tr> <tr> <td>50-99</td> <td>\$44.75</td> </tr> <tr> <td>100 +</td> <td>\$41.62</td> </tr> </tbody> </table> <p>Model No: PE9468 MCX Jack To BNC Male</p>	PRICE		1-24	\$52.03	25-49	\$48.39	50-99	\$44.75	100 +	\$41.62	 <table border="1"> <thead> <tr> <th colspan="2">PRICE</th> </tr> </thead> <tbody> <tr> <td>1-24</td> <td>\$58.87</td> </tr> <tr> <td>25-49</td> <td>\$54.75</td> </tr> <tr> <td>50-99</td> <td>\$50.63</td> </tr> <tr> <td>100 +</td> <td>\$47.10</td> </tr> </tbody> </table> <p>Model No: PE9466 MCX Jack To BNC Female</p>	PRICE		1-24	\$58.87	25-49	\$54.75	50-99	\$50.63	100 +	\$47.10	 <table border="1"> <thead> <tr> <th colspan="2">PRICE</th> </tr> </thead> <tbody> <tr> <td>1-24</td> <td>\$64.70</td> </tr> <tr> <td>25-49</td> <td>\$60.17</td> </tr> <tr> <td>50-99</td> <td>\$55.64</td> </tr> <tr> <td>100 +</td> <td>\$51.76</td> </tr> </tbody> </table> <p>Model No: PE9520 MCX Jack Bulkhead To BNC Female Mounting Hole B04</p>	PRICE		1-24	\$64.70	25-49	\$60.17	50-99	\$55.64	100 +	\$51.76
PRICE																																												
1-24	\$57.81																																											
25-49	\$53.76																																											
50-99	\$49.72																																											
100 +	\$46.25																																											
PRICE																																												
1-24	\$52.03																																											
25-49	\$48.39																																											
50-99	\$44.75																																											
100 +	\$41.62																																											
PRICE																																												
1-24	\$58.87																																											
25-49	\$54.75																																											
50-99	\$50.63																																											
100 +	\$47.10																																											
PRICE																																												
1-24	\$64.70																																											
25-49	\$60.17																																											
50-99	\$55.64																																											
100 +	\$51.76																																											
2	<p>SMB In-Series</p> <p>→</p>																																											
		 <table border="1"> <thead> <tr> <th colspan="2">PRICE</th> </tr> </thead> <tbody> <tr> <td>1-24</td> <td>\$23.15</td> </tr> <tr> <td>25-49</td> <td>\$21.53</td> </tr> <tr> <td>50-99</td> <td>\$19.91</td> </tr> <tr> <td>100 +</td> <td>\$18.52</td> </tr> </tbody> </table> <p>Model No: PE9118 SMB Plug To SMB Plug</p>	PRICE		1-24	\$23.15	25-49	\$21.53	50-99	\$19.91	100 +	\$18.52	 <table border="1"> <thead> <tr> <th colspan="2">PRICE</th> </tr> </thead> <tbody> <tr> <td>1-24</td> <td>\$33.08</td> </tr> <tr> <td>25-49</td> <td>\$30.76</td> </tr> <tr> <td>50-99</td> <td>\$28.45</td> </tr> <tr> <td>100 +</td> <td>\$26.46</td> </tr> </tbody> </table> <p>Model No: PE9120 SMB Plug To SMB Jack</p>	PRICE		1-24	\$33.08	25-49	\$30.76	50-99	\$28.45	100 +	\$26.46	 <table border="1"> <thead> <tr> <th colspan="2">PRICE</th> </tr> </thead> <tbody> <tr> <td>1-24</td> <td>\$20.52</td> </tr> <tr> <td>25-49</td> <td>\$19.08</td> </tr> <tr> <td>50-99</td> <td>\$17.65</td> </tr> <tr> <td>100 +</td> <td>\$16.42</td> </tr> </tbody> </table> <p>Model No: PE9116 SMB Jack To SMB Jack</p>	PRICE		1-24	\$20.52	25-49	\$19.08	50-99	\$17.65	100 +	\$16.42										
PRICE																																												
1-24	\$23.15																																											
25-49	\$21.53																																											
50-99	\$19.91																																											
100 +	\$18.52																																											
PRICE																																												
1-24	\$33.08																																											
25-49	\$30.76																																											
50-99	\$28.45																																											
100 +	\$26.46																																											
PRICE																																												
1-24	\$20.52																																											
25-49	\$19.08																																											
50-99	\$17.65																																											
100 +	\$16.42																																											
3	 <table border="1"> <thead> <tr> <th colspan="2">PRICE</th> </tr> </thead> <tbody> <tr> <td>1-24</td> <td>\$24.17</td> </tr> <tr> <td>25-49</td> <td>\$22.48</td> </tr> <tr> <td>50-99</td> <td>\$20.79</td> </tr> <tr> <td>100 +</td> <td>\$19.34</td> </tr> </tbody> </table> <p>Model No: PE9122 SMB Jack To SMB Jack Bulkhead Mounting Hole B01</p>	PRICE		1-24	\$24.17	25-49	\$22.48	50-99	\$20.79	100 +	\$19.34	 <table border="1"> <thead> <tr> <th colspan="2">PRICE</th> </tr> </thead> <tbody> <tr> <td>1-24</td> <td>\$47.12</td> </tr> <tr> <td>25-49</td> <td>\$43.82</td> </tr> <tr> <td>50-99</td> <td>\$40.52</td> </tr> <tr> <td>100 +</td> <td>\$37.70</td> </tr> </tbody> </table> <p>Model No: PE9310 SMB "T" Plug-Plug-Plug</p>	PRICE		1-24	\$47.12	25-49	\$43.82	50-99	\$40.52	100 +	\$37.70	 <table border="1"> <thead> <tr> <th colspan="2">PRICE</th> </tr> </thead> <tbody> <tr> <td>1-24</td> <td>\$27.76</td> </tr> <tr> <td>25-49</td> <td>\$25.82</td> </tr> <tr> <td>50-99</td> <td>\$23.87</td> </tr> <tr> <td>100 +</td> <td>\$22.21</td> </tr> </tbody> </table> <p>Model No: PE9243 SMB "T" Jack-Plug-Jack</p>	PRICE		1-24	\$27.76	25-49	\$25.82	50-99	\$23.87	100 +	\$22.21	 <table border="1"> <thead> <tr> <th colspan="2">PRICE</th> </tr> </thead> <tbody> <tr> <td>1-24</td> <td>\$52.03</td> </tr> <tr> <td>25-49</td> <td>\$48.39</td> </tr> <tr> <td>50-99</td> <td>\$44.75</td> </tr> <tr> <td>100 +</td> <td>\$41.62</td> </tr> </tbody> </table> <p>Model No: PE9309 SMB "T" Plug-Jack-Jack</p>	PRICE		1-24	\$52.03	25-49	\$48.39	50-99	\$44.75	100 +	\$41.62
PRICE																																												
1-24	\$24.17																																											
25-49	\$22.48																																											
50-99	\$20.79																																											
100 +	\$19.34																																											
PRICE																																												
1-24	\$47.12																																											
25-49	\$43.82																																											
50-99	\$40.52																																											
100 +	\$37.70																																											
PRICE																																												
1-24	\$27.76																																											
25-49	\$25.82																																											
50-99	\$23.87																																											
100 +	\$22.21																																											
PRICE																																												
1-24	\$52.03																																											
25-49	\$48.39																																											
50-99	\$44.75																																											
100 +	\$41.62																																											
4	 <table border="1"> <thead> <tr> <th colspan="2">PRICE</th> </tr> </thead> <tbody> <tr> <td>1-24</td> <td>\$33.79</td> </tr> <tr> <td>25-49</td> <td>\$31.42</td> </tr> <tr> <td>50-99</td> <td>\$29.06</td> </tr> <tr> <td>100 +</td> <td>\$27.03</td> </tr> </tbody> </table> <p>Model No: PE9302 SMB "T" Jack-Jack-Jack</p>	PRICE		1-24	\$33.79	25-49	\$31.42	50-99	\$29.06	100 +	\$27.03	<p>SMB Between-Series</p> <p>→</p>		 <table border="1"> <thead> <tr> <th colspan="2">PRICE</th> </tr> </thead> <tbody> <tr> <td>1-24</td> <td>\$38.71</td> </tr> <tr> <td>25-49</td> <td>\$36.00</td> </tr> <tr> <td>50-99</td> <td>\$33.29</td> </tr> <tr> <td>100 +</td> <td>\$30.97</td> </tr> </tbody> </table> <p>Model No: PE9135 SMB Plug To BNC Male</p>	PRICE		1-24	\$38.71	25-49	\$36.00	50-99	\$33.29	100 +	\$30.97	 <table border="1"> <thead> <tr> <th colspan="2">PRICE</th> </tr> </thead> <tbody> <tr> <td>1-24</td> <td>\$41.54</td> </tr> <tr> <td>25-49</td> <td>\$38.63</td> </tr> <tr> <td>50-99</td> <td>\$35.72</td> </tr> <tr> <td>100 +</td> <td>\$33.23</td> </tr> </tbody> </table> <p>Model No: PE9137 SMB Plug To BNC Female</p>	PRICE		1-24	\$41.54	25-49	\$38.63	50-99	\$35.72	100 +	\$33.23									
PRICE																																												
1-24	\$33.79																																											
25-49	\$31.42																																											
50-99	\$29.06																																											
100 +	\$27.03																																											
PRICE																																												
1-24	\$38.71																																											
25-49	\$36.00																																											
50-99	\$33.29																																											
100 +	\$30.97																																											
PRICE																																												
1-24	\$41.54																																											
25-49	\$38.63																																											
50-99	\$35.72																																											
100 +	\$33.23																																											
5	 <table border="1"> <thead> <tr> <th colspan="2">PRICE</th> </tr> </thead> <tbody> <tr> <td>1-24</td> <td>\$34.35</td> </tr> <tr> <td>25-49</td> <td>\$31.95</td> </tr> <tr> <td>50-99</td> <td>\$29.54</td> </tr> <tr> <td>100 +</td> <td>\$27.48</td> </tr> </tbody> </table> <p>Model No: PE9241 SMB Plug Bulkhead To BNC Female Mounting Hole B05</p>	PRICE		1-24	\$34.35	25-49	\$31.95	50-99	\$29.54	100 +	\$27.48	 <table border="1"> <thead> <tr> <th colspan="2">PRICE</th> </tr> </thead> <tbody> <tr> <td>1-24</td> <td>\$39.42</td> </tr> <tr> <td>25-49</td> <td>\$36.66</td> </tr> <tr> <td>50-99</td> <td>\$33.90</td> </tr> <tr> <td>100 +</td> <td>\$31.54</td> </tr> </tbody> </table> <p>Model No: PE9132 SMB Jack To BNC Male</p>	PRICE		1-24	\$39.42	25-49	\$36.66	50-99	\$33.90	100 +	\$31.54	 <table border="1"> <thead> <tr> <th colspan="2">PRICE</th> </tr> </thead> <tbody> <tr> <td>1-24</td> <td>\$40.81</td> </tr> <tr> <td>25-49</td> <td>\$37.95</td> </tr> <tr> <td>50-99</td> <td>\$35.10</td> </tr> <tr> <td>100 +</td> <td>\$32.65</td> </tr> </tbody> </table> <p>Model No: PE9136 SMB Jack To BNC Female</p>	PRICE		1-24	\$40.81	25-49	\$37.95	50-99	\$35.10	100 +	\$32.65	 <table border="1"> <thead> <tr> <th colspan="2">PRICE</th> </tr> </thead> <tbody> <tr> <td>1-24</td> <td>\$37.14</td> </tr> <tr> <td>25-49</td> <td>\$34.54</td> </tr> <tr> <td>50-99</td> <td>\$31.94</td> </tr> <tr> <td>100 +</td> <td>\$29.71</td> </tr> </tbody> </table> <p>Model No: PE9240 SMB Jack Bulkhead To BNC Female Mounting Hole B05</p>	PRICE		1-24	\$37.14	25-49	\$34.54	50-99	\$31.94	100 +	\$29.71
PRICE																																												
1-24	\$34.35																																											
25-49	\$31.95																																											
50-99	\$29.54																																											
100 +	\$27.48																																											
PRICE																																												
1-24	\$39.42																																											
25-49	\$36.66																																											
50-99	\$33.90																																											
100 +	\$31.54																																											
PRICE																																												
1-24	\$40.81																																											
25-49	\$37.95																																											
50-99	\$35.10																																											
100 +	\$32.65																																											
PRICE																																												
1-24	\$37.14																																											
25-49	\$34.54																																											
50-99	\$31.94																																											
100 +	\$29.71																																											
6	<p>SSMB Between-Series</p> <p>→</p>																																											
		 <table border="1"> <thead> <tr> <th colspan="2">PRICE</th> </tr> </thead> <tbody> <tr> <td>1-24</td> <td>\$58.87</td> </tr> <tr> <td>25-49</td> <td>\$54.75</td> </tr> <tr> <td>50-99</td> <td>\$50.63</td> </tr> <tr> <td>100 +</td> <td>\$47.10</td> </tr> </tbody> </table> <p>Model No: PE9393 SSMB Plug To BNC Male</p>	PRICE		1-24	\$58.87	25-49	\$54.75	50-99	\$50.63	100 +	\$47.10	 <table border="1"> <thead> <tr> <th colspan="2">PRICE</th> </tr> </thead> <tbody> <tr> <td>1-24</td> <td>\$58.87</td> </tr> <tr> <td>25-49</td> <td>\$54.75</td> </tr> <tr> <td>50-99</td> <td>\$50.63</td> </tr> <tr> <td>100 +</td> <td>\$47.10</td> </tr> </tbody> </table> <p>Model No: PE9395 SSMB Plug To BNC Female</p>	PRICE		1-24	\$58.87	25-49	\$54.75	50-99	\$50.63	100 +	\$47.10	 <table border="1"> <thead> <tr> <th colspan="2">PRICE</th> </tr> </thead> <tbody> <tr> <td>1-24</td> <td>\$58.87</td> </tr> <tr> <td>25-49</td> <td>\$54.75</td> </tr> <tr> <td>50-99</td> <td>\$50.63</td> </tr> <tr> <td>100 +</td> <td>\$47.10</td> </tr> </tbody> </table> <p>Model No: PE9392 SSMB Jack To BNC Male</p>	PRICE		1-24	\$58.87	25-49	\$54.75	50-99	\$50.63	100 +	\$47.10										
PRICE																																												
1-24	\$58.87																																											
25-49	\$54.75																																											
50-99	\$50.63																																											
100 +	\$47.10																																											
PRICE																																												
1-24	\$58.87																																											
25-49	\$54.75																																											
50-99	\$50.63																																											
100 +	\$47.10																																											
PRICE																																												
1-24	\$58.87																																											
25-49	\$54.75																																											
50-99	\$50.63																																											
100 +	\$47.10																																											



Free Freight Available
via UPS Ground
to USA & Canada



Real-Time Stock
Levels & Pricing
On Our Website



Toll-Free Technical
Support
(866) 727-8376











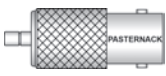

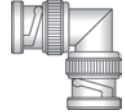

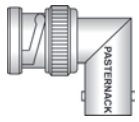
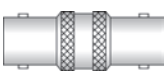
Same-Day Shipping,
Even Custom
Cable Assemblies

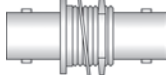
ADAPTERS

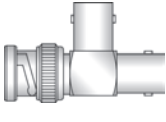
See Adapter Locator on Pages 140-145 or the Adapter Matrix on Pages 138-139

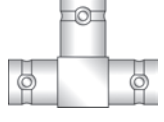
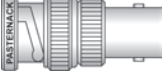
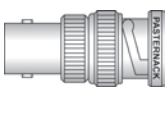
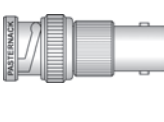
See Page 246 for Mounting Holes

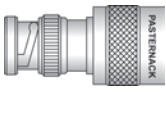
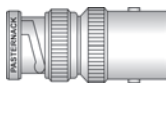
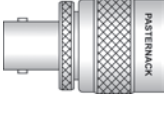
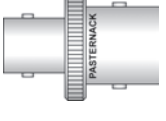
	A	B	C	D																																								
1	 <table border="1"> <thead> <tr> <th colspan="2">PRICE</th> </tr> </thead> <tbody> <tr> <td>1-24</td> <td>\$61.91</td> </tr> <tr> <td>25-49</td> <td>\$57.58</td> </tr> <tr> <td>50-99</td> <td>\$53.24</td> </tr> <tr> <td>100 +</td> <td>\$49.53</td> </tr> </tbody> </table> <p>Model No: PE9394 SSMB Jack To BNC Female</p>	PRICE		1-24	\$61.91	25-49	\$57.58	50-99	\$53.24	100 +	\$49.53	<p style="text-align: center;">BNC In-Series</p> <p style="text-align: center;">→</p>	 <table border="1"> <thead> <tr> <th colspan="2">PRICE</th> </tr> </thead> <tbody> <tr> <td>1-24</td> <td>\$11.60</td> </tr> <tr> <td>25-49</td> <td>\$10.79</td> </tr> <tr> <td>50-99</td> <td>\$9.98</td> </tr> <tr> <td>100 +</td> <td>\$9.28</td> </tr> </tbody> </table> <p>Model No: PE9000 BNC Male To BNC Male</p>	PRICE		1-24	\$11.60	25-49	\$10.79	50-99	\$9.98	100 +	\$9.28	 <table border="1"> <thead> <tr> <th colspan="2">PRICE</th> </tr> </thead> <tbody> <tr> <td>1-24</td> <td>\$34.71</td> </tr> <tr> <td>25-49</td> <td>\$32.28</td> </tr> <tr> <td>50-99</td> <td>\$29.85</td> </tr> <tr> <td>100 +</td> <td>\$27.77</td> </tr> </tbody> </table> <p>Model No: PE9758 BNC Male To BNC Male Right Angle</p>	PRICE		1-24	\$34.71	25-49	\$32.28	50-99	\$29.85	100 +	\$27.77										
	PRICE																																											
1-24	\$61.91																																											
25-49	\$57.58																																											
50-99	\$53.24																																											
100 +	\$49.53																																											
PRICE																																												
1-24	\$11.60																																											
25-49	\$10.79																																											
50-99	\$9.98																																											
100 +	\$9.28																																											
PRICE																																												
1-24	\$34.71																																											
25-49	\$32.28																																											
50-99	\$29.85																																											
100 +	\$27.77																																											
2	 <table border="1"> <thead> <tr> <th colspan="2">PRICE</th> </tr> </thead> <tbody> <tr> <td>1-24</td> <td>\$16.10</td> </tr> <tr> <td>25-49</td> <td>\$14.97</td> </tr> <tr> <td>50-99</td> <td>\$13.85</td> </tr> <tr> <td>100 +</td> <td>\$12.88</td> </tr> </tbody> </table> <p>Model No: PE9269 BNC Male To BNC Female</p>	PRICE		1-24	\$16.10	25-49	\$14.97	50-99	\$13.85	100 +	\$12.88	 <table border="1"> <thead> <tr> <th colspan="2">PRICE</th> </tr> </thead> <tbody> <tr> <td>1-24</td> <td>\$13.58</td> </tr> <tr> <td>25-49</td> <td>\$12.63</td> </tr> <tr> <td>50-99</td> <td>\$11.68</td> </tr> <tr> <td>100 +</td> <td>\$10.86</td> </tr> </tbody> </table> <p>Model No: PE9085 BNC Male To BNC Female Right Angle</p>	PRICE		1-24	\$13.58	25-49	\$12.63	50-99	\$11.68	100 +	\$10.86	 <table border="1"> <thead> <tr> <th colspan="2">PRICE</th> </tr> </thead> <tbody> <tr> <td>1-24</td> <td>\$7.24</td> </tr> <tr> <td>25-49</td> <td>\$6.73</td> </tr> <tr> <td>50-99</td> <td>\$6.23</td> </tr> <tr> <td>100 +</td> <td>\$5.79</td> </tr> </tbody> </table> <p>Model No: PE9084 BNC Female To BNC Female</p>	PRICE		1-24	\$7.24	25-49	\$6.73	50-99	\$6.23	100 +	\$5.79	 <table border="1"> <thead> <tr> <th colspan="2">PRICE</th> </tr> </thead> <tbody> <tr> <td>1-24</td> <td>\$12.54</td> </tr> <tr> <td>25-49</td> <td>\$11.66</td> </tr> <tr> <td>50-99</td> <td>\$10.78</td> </tr> <tr> <td>100 +</td> <td>\$10.03</td> </tr> </tbody> </table> <p>Model No: PE9093 BNC Female To BNC Female Bulkhead, Hermetically Sealed Mounting Hole B06</p>	PRICE		1-24	\$12.54	25-49	\$11.66	50-99	\$10.78	100 +	\$10.03
	PRICE																																											
1-24	\$16.10																																											
25-49	\$14.97																																											
50-99	\$13.85																																											
100 +	\$12.88																																											
PRICE																																												
1-24	\$13.58																																											
25-49	\$12.63																																											
50-99	\$11.68																																											
100 +	\$10.86																																											
PRICE																																												
1-24	\$7.24																																											
25-49	\$6.73																																											
50-99	\$6.23																																											
100 +	\$5.79																																											
PRICE																																												
1-24	\$12.54																																											
25-49	\$11.66																																											
50-99	\$10.78																																											
100 +	\$10.03																																											
3	 <table border="1"> <thead> <tr> <th colspan="2">PRICE</th> </tr> </thead> <tbody> <tr> <td>1-24</td> <td>\$43.27</td> </tr> <tr> <td>25-49</td> <td>\$40.24</td> </tr> <tr> <td>50-99</td> <td>\$37.21</td> </tr> <tr> <td>100 +</td> <td>\$34.62</td> </tr> </tbody> </table> <p>Model No: PE9420 BNC Female To BNC Female Bulkhead, Hermetically Sealed 1" Max Panel Mounting Hole B06</p>	PRICE		1-24	\$43.27	25-49	\$40.24	50-99	\$37.21	100 +	\$34.62	 <table border="1"> <thead> <tr> <th colspan="2">PRICE</th> </tr> </thead> <tbody> <tr> <td>1-24</td> <td>\$19.40</td> </tr> <tr> <td>25-49</td> <td>\$18.04</td> </tr> <tr> <td>50-99</td> <td>\$16.68</td> </tr> <tr> <td>100 +</td> <td>\$15.52</td> </tr> </tbody> </table> <p>Model No: PE9172 BNC Female To BNC Female Bulkhead, Isolated Ground Mounting Hole B06</p>	PRICE		1-24	\$19.40	25-49	\$18.04	50-99	\$16.68	100 +	\$15.52	 <table border="1"> <thead> <tr> <th colspan="2">PRICE</th> </tr> </thead> <tbody> <tr> <td>1-24</td> <td>\$11.38</td> </tr> <tr> <td>25-49</td> <td>\$10.58</td> </tr> <tr> <td>50-99</td> <td>\$9.79</td> </tr> <tr> <td>100 +</td> <td>\$9.10</td> </tr> </tbody> </table> <p>Model No: PE9106 BNC Female To BNC Female Panel Mount Mounting Hole A03</p>	PRICE		1-24	\$11.38	25-49	\$10.58	50-99	\$9.79	100 +	\$9.10	 <table border="1"> <thead> <tr> <th colspan="2">PRICE</th> </tr> </thead> <tbody> <tr> <td>1-24</td> <td>\$14.90</td> </tr> <tr> <td>25-49</td> <td>\$13.86</td> </tr> <tr> <td>50-99</td> <td>\$12.81</td> </tr> <tr> <td>100 +</td> <td>\$11.92</td> </tr> </tbody> </table> <p>Model No: PE9001 BNC "T" Female-Male-Female</p>	PRICE		1-24	\$14.90	25-49	\$13.86	50-99	\$12.81	100 +	\$11.92
	PRICE																																											
1-24	\$43.27																																											
25-49	\$40.24																																											
50-99	\$37.21																																											
100 +	\$34.62																																											
PRICE																																												
1-24	\$19.40																																											
25-49	\$18.04																																											
50-99	\$16.68																																											
100 +	\$15.52																																											
PRICE																																												
1-24	\$11.38																																											
25-49	\$10.58																																											
50-99	\$9.79																																											
100 +	\$9.10																																											
PRICE																																												
1-24	\$14.90																																											
25-49	\$13.86																																											
50-99	\$12.81																																											
100 +	\$11.92																																											
4	 <table border="1"> <thead> <tr> <th colspan="2">PRICE</th> </tr> </thead> <tbody> <tr> <td>1-24</td> <td>\$37.55</td> </tr> <tr> <td>25-49</td> <td>\$34.92</td> </tr> <tr> <td>50-99</td> <td>\$32.29</td> </tr> <tr> <td>100 +</td> <td>\$30.04</td> </tr> </tbody> </table> <p>Model No: PE9174 BNC "T" Male-Female-Female</p>	PRICE		1-24	\$37.55	25-49	\$34.92	50-99	\$32.29	100 +	\$30.04	 <table border="1"> <thead> <tr> <th colspan="2">PRICE</th> </tr> </thead> <tbody> <tr> <td>1-24</td> <td>\$34.98</td> </tr> <tr> <td>25-49</td> <td>\$32.53</td> </tr> <tr> <td>50-99</td> <td>\$30.08</td> </tr> <tr> <td>100 +</td> <td>\$27.98</td> </tr> </tbody> </table> <p>Model No: PE9484 BNC "Y" Female-Male-Female</p>	PRICE		1-24	\$34.98	25-49	\$32.53	50-99	\$30.08	100 +	\$27.98	 <table border="1"> <thead> <tr> <th colspan="2">PRICE</th> </tr> </thead> <tbody> <tr> <td>1-24</td> <td>\$17.48</td> </tr> <tr> <td>25-49</td> <td>\$16.26</td> </tr> <tr> <td>50-99</td> <td>\$15.03</td> </tr> <tr> <td>100 +</td> <td>\$13.98</td> </tr> </tbody> </table> <p>Model No: PE9003 BNC "T" Female-Female-Female</p>	PRICE		1-24	\$17.48	25-49	\$16.26	50-99	\$15.03	100 +	\$13.98	 <table border="1"> <thead> <tr> <th colspan="2">PRICE</th> </tr> </thead> <tbody> <tr> <td>1-24</td> <td>\$29.84</td> </tr> <tr> <td>25-49</td> <td>\$27.75</td> </tr> <tr> <td>50-99</td> <td>\$25.66</td> </tr> <tr> <td>100 +</td> <td>\$23.87</td> </tr> </tbody> </table> <p>Model No: PE9530 Standard BNC Male To Reverse Polarity BNC Female</p>	PRICE		1-24	\$29.84	25-49	\$27.75	50-99	\$25.66	100 +	\$23.87
	PRICE																																											
1-24	\$37.55																																											
25-49	\$34.92																																											
50-99	\$32.29																																											
100 +	\$30.04																																											
PRICE																																												
1-24	\$34.98																																											
25-49	\$32.53																																											
50-99	\$30.08																																											
100 +	\$27.98																																											
PRICE																																												
1-24	\$17.48																																											
25-49	\$16.26																																											
50-99	\$15.03																																											
100 +	\$13.98																																											
PRICE																																												
1-24	\$29.84																																											
25-49	\$27.75																																											
50-99	\$25.66																																											
100 +	\$23.87																																											
5	 <table border="1"> <thead> <tr> <th colspan="2">PRICE</th> </tr> </thead> <tbody> <tr> <td>1-24</td> <td>\$29.08</td> </tr> <tr> <td>25-49</td> <td>\$27.04</td> </tr> <tr> <td>50-99</td> <td>\$25.01</td> </tr> <tr> <td>100 +</td> <td>\$23.26</td> </tr> </tbody> </table> <p>Model No: PE9529 Standard BNC Female To Reverse Polarity BNC Male</p>	PRICE		1-24	\$29.08	25-49	\$27.04	50-99	\$25.01	100 +	\$23.26	<p style="text-align: center;">BNC Between-Series</p> <p style="text-align: center;">→</p>	 <table border="1"> <thead> <tr> <th colspan="2">PRICE</th> </tr> </thead> <tbody> <tr> <td>1-24</td> <td>\$77.92</td> </tr> <tr> <td>25-49</td> <td>\$72.47</td> </tr> <tr> <td>50-99</td> <td>\$67.01</td> </tr> <tr> <td>100 +</td> <td>\$62.34</td> </tr> </tbody> </table> <p>Model No: PE9406 BNC Male To MHV Female</p>	PRICE		1-24	\$77.92	25-49	\$72.47	50-99	\$67.01	100 +	\$62.34	 <table border="1"> <thead> <tr> <th colspan="2">PRICE</th> </tr> </thead> <tbody> <tr> <td>1-24</td> <td>\$31.06</td> </tr> <tr> <td>25-49</td> <td>\$28.89</td> </tr> <tr> <td>50-99</td> <td>\$26.71</td> </tr> <tr> <td>100 +</td> <td>\$24.85</td> </tr> </tbody> </table> <p>Model No: PE9297 BNC Female To MHV Male</p>	PRICE		1-24	\$31.06	25-49	\$28.89	50-99	\$26.71	100 +	\$24.85										
	PRICE																																											
1-24	\$29.08																																											
25-49	\$27.04																																											
50-99	\$25.01																																											
100 +	\$23.26																																											
PRICE																																												
1-24	\$77.92																																											
25-49	\$72.47																																											
50-99	\$67.01																																											
100 +	\$62.34																																											
PRICE																																												
1-24	\$31.06																																											
25-49	\$28.89																																											
50-99	\$26.71																																											
100 +	\$24.85																																											
6	 <table border="1"> <thead> <tr> <th colspan="2">PRICE</th> </tr> </thead> <tbody> <tr> <td>1-24</td> <td>\$47.12</td> </tr> <tr> <td>25-49</td> <td>\$43.82</td> </tr> <tr> <td>50-99</td> <td>\$40.52</td> </tr> <tr> <td>100 +</td> <td>\$37.70</td> </tr> </tbody> </table> <p>Model No: PE9536 BNC Male To C Male</p>	PRICE		1-24	\$47.12	25-49	\$43.82	50-99	\$40.52	100 +	\$37.70	 <table border="1"> <thead> <tr> <th colspan="2">PRICE</th> </tr> </thead> <tbody> <tr> <td>1-24</td> <td>\$37.39</td> </tr> <tr> <td>25-49</td> <td>\$34.77</td> </tr> <tr> <td>50-99</td> <td>\$32.16</td> </tr> <tr> <td>100 +</td> <td>\$29.91</td> </tr> </tbody> </table> <p>Model No: PE9109 BNC Male To C Female</p>	PRICE		1-24	\$37.39	25-49	\$34.77	50-99	\$32.16	100 +	\$29.91	 <table border="1"> <thead> <tr> <th colspan="2">PRICE</th> </tr> </thead> <tbody> <tr> <td>1-24</td> <td>\$27.76</td> </tr> <tr> <td>25-49</td> <td>\$25.82</td> </tr> <tr> <td>50-99</td> <td>\$23.87</td> </tr> <tr> <td>100 +</td> <td>\$22.21</td> </tr> </tbody> </table> <p>Model No: PE9087 BNC Female To C Male</p>	PRICE		1-24	\$27.76	25-49	\$25.82	50-99	\$23.87	100 +	\$22.21	 <table border="1"> <thead> <tr> <th colspan="2">PRICE</th> </tr> </thead> <tbody> <tr> <td>1-24</td> <td>\$47.12</td> </tr> <tr> <td>25-49</td> <td>\$43.82</td> </tr> <tr> <td>50-99</td> <td>\$40.52</td> </tr> <tr> <td>100 +</td> <td>\$37.70</td> </tr> </tbody> </table> <p>Model No: PE9537 BNC Female To C Female</p>	PRICE		1-24	\$47.12	25-49	\$43.82	50-99	\$40.52	100 +	\$37.70
	PRICE																																											
1-24	\$47.12																																											
25-49	\$43.82																																											
50-99	\$40.52																																											
100 +	\$37.70																																											
PRICE																																												
1-24	\$37.39																																											
25-49	\$34.77																																											
50-99	\$32.16																																											
100 +	\$29.91																																											
PRICE																																												
1-24	\$27.76																																											
25-49	\$25.82																																											
50-99	\$23.87																																											
100 +	\$22.21																																											
PRICE																																												
1-24	\$47.12																																											
25-49	\$43.82																																											
50-99	\$40.52																																											
100 +	\$37.70																																											











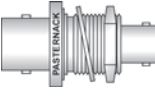
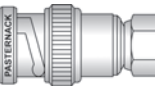
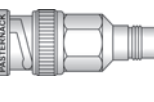
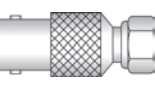

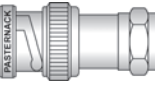

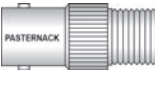
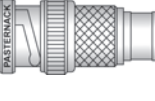

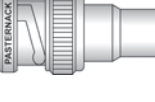

Adapters

See Our Website For Real-Time Stock Availability!

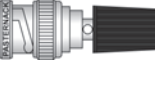
ADAPTERS

See Adapter Locator on Pages 140-145 or the Adapter Matrix on Pages 138-139

See Page 246 for Mounting Holes

	A	B	C	D																																								
1	 <table border="1"> <thead> <tr> <th colspan="2">PRICE</th> </tr> </thead> <tbody> <tr> <td>1-24</td> <td>\$70.68</td> </tr> <tr> <td>25-49</td> <td>\$65.73</td> </tr> <tr> <td>50-99</td> <td>\$60.78</td> </tr> <tr> <td>100 +</td> <td>\$56.54</td> </tr> </tbody> </table> <p>Model No: PE9204 BNC Female To C Female Bulkhead Mounting Hole G01</p>	PRICE		1-24	\$70.68	25-49	\$65.73	50-99	\$60.78	100 +	\$56.54	 <table border="1"> <thead> <tr> <th colspan="2">PRICE</th> </tr> </thead> <tbody> <tr> <td>1-24</td> <td>\$52.94</td> </tr> <tr> <td>25-49</td> <td>\$49.23</td> </tr> <tr> <td>50-99</td> <td>\$45.53</td> </tr> <tr> <td>100 +</td> <td>\$42.35</td> </tr> </tbody> </table> <p>Model No: PE9234 BNC Male To 75 Ohm SMC Plug</p>	PRICE		1-24	\$52.94	25-49	\$49.23	50-99	\$45.53	100 +	\$42.35	 <table border="1"> <thead> <tr> <th colspan="2">PRICE</th> </tr> </thead> <tbody> <tr> <td>1-24</td> <td>\$45.45</td> </tr> <tr> <td>25-49</td> <td>\$42.27</td> </tr> <tr> <td>50-99</td> <td>\$39.09</td> </tr> <tr> <td>100 +</td> <td>\$36.36</td> </tr> </tbody> </table> <p>Model No: PE9233 BNC Male To 75 Ohm SMC Jack</p>	PRICE		1-24	\$45.45	25-49	\$42.27	50-99	\$39.09	100 +	\$36.36	 <table border="1"> <thead> <tr> <th colspan="2">PRICE</th> </tr> </thead> <tbody> <tr> <td>1-24</td> <td>\$52.94</td> </tr> <tr> <td>25-49</td> <td>\$49.23</td> </tr> <tr> <td>50-99</td> <td>\$45.53</td> </tr> <tr> <td>100 +</td> <td>\$42.35</td> </tr> </tbody> </table> <p>Model No: PE9236 BNC Female To 75 Ohm SMC Plug</p>	PRICE		1-24	\$52.94	25-49	\$49.23	50-99	\$45.53	100 +	\$42.35
	PRICE																																											
1-24	\$70.68																																											
25-49	\$65.73																																											
50-99	\$60.78																																											
100 +	\$56.54																																											
PRICE																																												
1-24	\$52.94																																											
25-49	\$49.23																																											
50-99	\$45.53																																											
100 +	\$42.35																																											
PRICE																																												
1-24	\$45.45																																											
25-49	\$42.27																																											
50-99	\$39.09																																											
100 +	\$36.36																																											
PRICE																																												
1-24	\$52.94																																											
25-49	\$49.23																																											
50-99	\$45.53																																											
100 +	\$42.35																																											
2	 <table border="1"> <thead> <tr> <th colspan="2">PRICE</th> </tr> </thead> <tbody> <tr> <td>1-24</td> <td>\$52.94</td> </tr> <tr> <td>25-49</td> <td>\$49.23</td> </tr> <tr> <td>50-99</td> <td>\$45.53</td> </tr> <tr> <td>100 +</td> <td>\$42.35</td> </tr> </tbody> </table> <p>Model No: PE9235 BNC Female To 75 Ohm SMC Jack</p>	PRICE		1-24	\$52.94	25-49	\$49.23	50-99	\$45.53	100 +	\$42.35	 <table border="1"> <thead> <tr> <th colspan="2">PRICE</th> </tr> </thead> <tbody> <tr> <td>1-24</td> <td>\$10.84</td> </tr> <tr> <td>25-49</td> <td>\$10.08</td> </tr> <tr> <td>50-99</td> <td>\$9.32</td> </tr> <tr> <td>100 +</td> <td>\$8.67</td> </tr> </tbody> </table> <p>Model No: PE9152 BNC Male To F Male</p>	PRICE		1-24	\$10.84	25-49	\$10.08	50-99	\$9.32	100 +	\$8.67	 <table border="1"> <thead> <tr> <th colspan="2">PRICE</th> </tr> </thead> <tbody> <tr> <td>1-24</td> <td>\$11.70</td> </tr> <tr> <td>25-49</td> <td>\$10.88</td> </tr> <tr> <td>50-99</td> <td>\$10.06</td> </tr> <tr> <td>100 +</td> <td>\$9.36</td> </tr> </tbody> </table> <p>Model No: PE9150 BNC Male To F Female</p>	PRICE		1-24	\$11.70	25-49	\$10.88	50-99	\$10.06	100 +	\$9.36	 <table border="1"> <thead> <tr> <th colspan="2">PRICE</th> </tr> </thead> <tbody> <tr> <td>1-24</td> <td>\$11.59</td> </tr> <tr> <td>25-49</td> <td>\$10.78</td> </tr> <tr> <td>50-99</td> <td>\$9.97</td> </tr> <tr> <td>100 +</td> <td>\$9.27</td> </tr> </tbody> </table> <p>Model No: PE9151 BNC Female To F Male</p>	PRICE		1-24	\$11.59	25-49	\$10.78	50-99	\$9.97	100 +	\$9.27
	PRICE																																											
1-24	\$52.94																																											
25-49	\$49.23																																											
50-99	\$45.53																																											
100 +	\$42.35																																											
PRICE																																												
1-24	\$10.84																																											
25-49	\$10.08																																											
50-99	\$9.32																																											
100 +	\$8.67																																											
PRICE																																												
1-24	\$11.70																																											
25-49	\$10.88																																											
50-99	\$10.06																																											
100 +	\$9.36																																											
PRICE																																												
1-24	\$11.59																																											
25-49	\$10.78																																											
50-99	\$9.97																																											
100 +	\$9.27																																											
3	 <table border="1"> <thead> <tr> <th colspan="2">PRICE</th> </tr> </thead> <tbody> <tr> <td>1-24</td> <td>\$10.84</td> </tr> <tr> <td>25-49</td> <td>\$10.08</td> </tr> <tr> <td>50-99</td> <td>\$9.32</td> </tr> <tr> <td>100 +</td> <td>\$8.67</td> </tr> </tbody> </table> <p>Model No: PE9153 BNC Female To F Female</p>	PRICE		1-24	\$10.84	25-49	\$10.08	50-99	\$9.32	100 +	\$8.67	 <table border="1"> <thead> <tr> <th colspan="2">PRICE</th> </tr> </thead> <tbody> <tr> <td>1-24</td> <td>\$45.45</td> </tr> <tr> <td>25-49</td> <td>\$42.27</td> </tr> <tr> <td>50-99</td> <td>\$39.09</td> </tr> <tr> <td>100 +</td> <td>\$36.36</td> </tr> </tbody> </table> <p>Model No: PE9230 BNC Male To 75 Ohm SMB Plug</p>	PRICE		1-24	\$45.45	25-49	\$42.27	50-99	\$39.09	100 +	\$36.36	 <table border="1"> <thead> <tr> <th colspan="2">PRICE</th> </tr> </thead> <tbody> <tr> <td>1-24</td> <td>\$45.45</td> </tr> <tr> <td>25-49</td> <td>\$42.27</td> </tr> <tr> <td>50-99</td> <td>\$39.09</td> </tr> <tr> <td>100 +</td> <td>\$36.36</td> </tr> </tbody> </table> <p>Model No: PE9229 BNC Male To 75 Ohm SMB Jack</p>	PRICE		1-24	\$45.45	25-49	\$42.27	50-99	\$39.09	100 +	\$36.36	 <table border="1"> <thead> <tr> <th colspan="2">PRICE</th> </tr> </thead> <tbody> <tr> <td>1-24</td> <td>\$45.45</td> </tr> <tr> <td>25-49</td> <td>\$42.27</td> </tr> <tr> <td>50-99</td> <td>\$39.09</td> </tr> <tr> <td>100 +</td> <td>\$36.36</td> </tr> </tbody> </table> <p>Model No: PE9232 BNC Female To 75 Ohm SMB Plug</p>	PRICE		1-24	\$45.45	25-49	\$42.27	50-99	\$39.09	100 +	\$36.36
	PRICE																																											
1-24	\$10.84																																											
25-49	\$10.08																																											
50-99	\$9.32																																											
100 +	\$8.67																																											
PRICE																																												
1-24	\$45.45																																											
25-49	\$42.27																																											
50-99	\$39.09																																											
100 +	\$36.36																																											
PRICE																																												
1-24	\$45.45																																											
25-49	\$42.27																																											
50-99	\$39.09																																											
100 +	\$36.36																																											
PRICE																																												
1-24	\$45.45																																											
25-49	\$42.27																																											
50-99	\$39.09																																											
100 +	\$36.36																																											
4	 <table border="1"> <thead> <tr> <th colspan="2">PRICE</th> </tr> </thead> <tbody> <tr> <td>1-24</td> <td>\$45.45</td> </tr> <tr> <td>25-49</td> <td>\$42.27</td> </tr> <tr> <td>50-99</td> <td>\$39.09</td> </tr> <tr> <td>100 +</td> <td>\$36.36</td> </tr> </tbody> </table> <p>Model No: PE9231 BNC Female To 75 Ohm SMB Jack</p>	PRICE		1-24	\$45.45	25-49	\$42.27	50-99	\$39.09	100 +	\$36.36	 <table border="1"> <thead> <tr> <th colspan="2">PRICE</th> </tr> </thead> <tbody> <tr> <td>1-24</td> <td>\$10.84</td> </tr> <tr> <td>25-49</td> <td>\$10.08</td> </tr> <tr> <td>50-99</td> <td>\$9.32</td> </tr> <tr> <td>100 +</td> <td>\$8.67</td> </tr> </tbody> </table> <p>Model No: PE9171 BNC Male To RCA Jack</p>	PRICE		1-24	\$10.84	25-49	\$10.08	50-99	\$9.32	100 +	\$8.67	 <table border="1"> <thead> <tr> <th colspan="2">PRICE</th> </tr> </thead> <tbody> <tr> <td>1-24</td> <td>\$11.10</td> </tr> <tr> <td>25-49</td> <td>\$10.32</td> </tr> <tr> <td>50-99</td> <td>\$9.55</td> </tr> <tr> <td>100 +</td> <td>\$8.88</td> </tr> </tbody> </table> <p>Model No: PE9158 BNC Female To RCA Plug</p>	PRICE		1-24	\$11.10	25-49	\$10.32	50-99	\$9.55	100 +	\$8.88	 <table border="1"> <thead> <tr> <th colspan="2">PRICE</th> </tr> </thead> <tbody> <tr> <td>1-24</td> <td>\$18.09</td> </tr> <tr> <td>25-49</td> <td>\$16.82</td> </tr> <tr> <td>50-99</td> <td>\$15.56</td> </tr> <tr> <td>100 +</td> <td>\$14.47</td> </tr> </tbody> </table> <p>Model No: PE9009 BNC Male To Double Banana Plug</p>	PRICE		1-24	\$18.09	25-49	\$16.82	50-99	\$15.56	100 +	\$14.47
	PRICE																																											
1-24	\$45.45																																											
25-49	\$42.27																																											
50-99	\$39.09																																											
100 +	\$36.36																																											
PRICE																																												
1-24	\$10.84																																											
25-49	\$10.08																																											
50-99	\$9.32																																											
100 +	\$8.67																																											
PRICE																																												
1-24	\$11.10																																											
25-49	\$10.32																																											
50-99	\$9.55																																											
100 +	\$8.88																																											
PRICE																																												
1-24	\$18.09																																											
25-49	\$16.82																																											
50-99	\$15.56																																											
100 +	\$14.47																																											
5	 <table border="1"> <thead> <tr> <th colspan="2">PRICE</th> </tr> </thead> <tbody> <tr> <td>1-24</td> <td>\$18.09</td> </tr> <tr> <td>25-49</td> <td>\$16.82</td> </tr> <tr> <td>50-99</td> <td>\$15.56</td> </tr> <tr> <td>100 +</td> <td>\$14.47</td> </tr> </tbody> </table> <p>Model No: PE9011 BNC Male To Binding Posts Double</p>	PRICE		1-24	\$18.09	25-49	\$16.82	50-99	\$15.56	100 +	\$14.47	 <table border="1"> <thead> <tr> <th colspan="2">PRICE</th> </tr> </thead> <tbody> <tr> <td>1-24</td> <td>\$10.99</td> </tr> <tr> <td>25-49</td> <td>\$10.22</td> </tr> <tr> <td>50-99</td> <td>\$9.45</td> </tr> <tr> <td>100 +</td> <td>\$8.79</td> </tr> </tbody> </table> <p>Model No: PE9169 BNC Male To Single Binding Post</p>	PRICE		1-24	\$10.99	25-49	\$10.22	50-99	\$9.45	100 +	\$8.79	 <table border="1"> <thead> <tr> <th colspan="2">PRICE</th> </tr> </thead> <tbody> <tr> <td>1-24</td> <td>\$16.21</td> </tr> <tr> <td>25-49</td> <td>\$15.08</td> </tr> <tr> <td>50-99</td> <td>\$13.94</td> </tr> <tr> <td>100 +</td> <td>\$12.97</td> </tr> </tbody> </table> <p>Model No: PE9008 BNC Female To Double Banana Plug</p>	PRICE		1-24	\$16.21	25-49	\$15.08	50-99	\$13.94	100 +	\$12.97	 <table border="1"> <thead> <tr> <th colspan="2">PRICE</th> </tr> </thead> <tbody> <tr> <td>1-24</td> <td>\$20.06</td> </tr> <tr> <td>25-49</td> <td>\$18.66</td> </tr> <tr> <td>50-99</td> <td>\$17.25</td> </tr> <tr> <td>100 +</td> <td>\$16.05</td> </tr> </tbody> </table> <p>Model No: PE9175 BNC Female To Single Banana Plug</p>	PRICE		1-24	\$20.06	25-49	\$18.66	50-99	\$17.25	100 +	\$16.05
	PRICE																																											
1-24	\$18.09																																											
25-49	\$16.82																																											
50-99	\$15.56																																											
100 +	\$14.47																																											
PRICE																																												
1-24	\$10.99																																											
25-49	\$10.22																																											
50-99	\$9.45																																											
100 +	\$8.79																																											
PRICE																																												
1-24	\$16.21																																											
25-49	\$15.08																																											
50-99	\$13.94																																											
100 +	\$12.97																																											
PRICE																																												
1-24	\$20.06																																											
25-49	\$18.66																																											
50-99	\$17.25																																											
100 +	\$16.05																																											
6	 <table border="1"> <thead> <tr> <th colspan="2">PRICE</th> </tr> </thead> <tbody> <tr> <td>1-24</td> <td>\$18.09</td> </tr> <tr> <td>25-49</td> <td>\$16.82</td> </tr> <tr> <td>50-99</td> <td>\$15.56</td> </tr> <tr> <td>100 +</td> <td>\$14.47</td> </tr> </tbody> </table> <p>Model No: PE9013 BNC Female To Binding Posts</p>	PRICE		1-24	\$18.09	25-49	\$16.82	50-99	\$15.56	100 +	\$14.47	 <table border="1"> <thead> <tr> <th colspan="2">PRICE</th> </tr> </thead> <tbody> <tr> <td>1-24</td> <td>\$116.78</td> </tr> <tr> <td>25-49</td> <td>\$108.61</td> </tr> <tr> <td>50-99</td> <td>\$100.43</td> </tr> <tr> <td>100 +</td> <td>\$93.42</td> </tr> </tbody> </table> <p>Model No: PE9223 BNC Male To GR874</p>	PRICE		1-24	\$116.78	25-49	\$108.61	50-99	\$100.43	100 +	\$93.42	 <table border="1"> <thead> <tr> <th colspan="2">PRICE</th> </tr> </thead> <tbody> <tr> <td>1-24</td> <td>\$116.78</td> </tr> <tr> <td>25-49</td> <td>\$108.61</td> </tr> <tr> <td>50-99</td> <td>\$100.43</td> </tr> <tr> <td>100 +</td> <td>\$93.42</td> </tr> </tbody> </table> <p>Model No: PE9222 BNC Female To GR874</p>	PRICE		1-24	\$116.78	25-49	\$108.61	50-99	\$100.43	100 +	\$93.42	<div style="text-align: center;"> <p>MHV <i>In-Series</i></p> <p>→</p> </div>										
	PRICE																																											
1-24	\$18.09																																											
25-49	\$16.82																																											
50-99	\$15.56																																											
100 +	\$14.47																																											
PRICE																																												
1-24	\$116.78																																											
25-49	\$108.61																																											
50-99	\$100.43																																											
100 +	\$93.42																																											
PRICE																																												
1-24	\$116.78																																											
25-49	\$108.61																																											
50-99	\$100.43																																											
100 +	\$93.42																																											

Adapters

See Our Website For Real-Time Stock Availability!











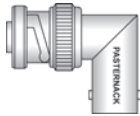
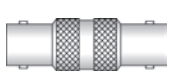
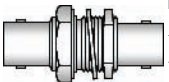



ADAPTERS

See Adapter Locator on Pages 140-145 or the Adapter Matrix on Pages 138-139

See Page 246 for Mounting Holes

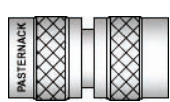
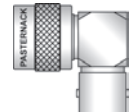
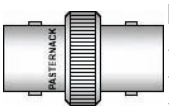
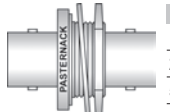
Adapters

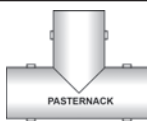









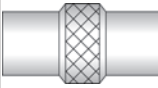
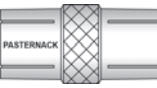
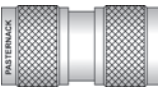

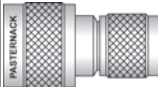
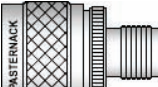

See Our Website For Real-Time Stock Availability!

	A	B	C	D																																									
1	 <table border="1"> <thead> <tr> <th colspan="2">PRICE</th> </tr> </thead> <tbody> <tr> <td>1-24</td> <td>\$45.55</td> </tr> <tr> <td>25-49</td> <td>\$42.36</td> </tr> <tr> <td>50-99</td> <td>\$39.17</td> </tr> <tr> <td>100 +</td> <td>\$36.44</td> </tr> </tbody> </table> <p>Model No: PE9266 MHV Male To MHV Female Right Angle</p>	PRICE		1-24	\$45.55	25-49	\$42.36	50-99	\$39.17	100 +	\$36.44	 <table border="1"> <thead> <tr> <th colspan="2">PRICE</th> </tr> </thead> <tbody> <tr> <td>1-24</td> <td>\$25.38</td> </tr> <tr> <td>25-49</td> <td>\$23.60</td> </tr> <tr> <td>50-99</td> <td>\$21.83</td> </tr> <tr> <td>100 +</td> <td>\$20.30</td> </tr> </tbody> </table> <p>Model No: PE9267 MHV Female To MHV Female</p>	PRICE		1-24	\$25.38	25-49	\$23.60	50-99	\$21.83	100 +	\$20.30	 <table border="1"> <thead> <tr> <th colspan="2">PRICE</th> </tr> </thead> <tbody> <tr> <td>1-24</td> <td>\$46.21</td> </tr> <tr> <td>25-49</td> <td>\$42.98</td> </tr> <tr> <td>50-99</td> <td>\$39.74</td> </tr> <tr> <td>100 +</td> <td>\$36.97</td> </tr> </tbody> </table> <p>Model No: PE9268 MHV Female To MHV Female Bulkhead, Hermetically Sealed Mounting Hole B06</p>	PRICE		1-24	\$46.21	25-49	\$42.98	50-99	\$39.74	100 +	\$36.97	 <table border="1"> <thead> <tr> <th colspan="2">PRICE</th> </tr> </thead> <tbody> <tr> <td>1-24</td> <td>\$42.25</td> </tr> <tr> <td>25-49</td> <td>\$39.29</td> </tr> <tr> <td>50-99</td> <td>\$36.34</td> </tr> <tr> <td>100 +</td> <td>\$33.80</td> </tr> </tbody> </table> <p>Model No: PE9211 MHV "T" Female-Male-Female</p>	PRICE		1-24	\$42.25	25-49	\$39.29	50-99	\$36.34	100 +	\$33.80	
PRICE																																													
1-24	\$45.55																																												
25-49	\$42.36																																												
50-99	\$39.17																																												
100 +	\$36.44																																												
PRICE																																													
1-24	\$25.38																																												
25-49	\$23.60																																												
50-99	\$21.83																																												
100 +	\$20.30																																												
PRICE																																													
1-24	\$46.21																																												
25-49	\$42.98																																												
50-99	\$39.74																																												
100 +	\$36.97																																												
PRICE																																													
1-24	\$42.25																																												
25-49	\$39.29																																												
50-99	\$36.34																																												
100 +	\$33.80																																												
2	MHV Between-Series 																																												
3	 <table border="1"> <thead> <tr> <th colspan="2">PRICE</th> </tr> </thead> <tbody> <tr> <td>1-24</td> <td>\$44.74</td> </tr> <tr> <td>25-49</td> <td>\$41.61</td> </tr> <tr> <td>50-99</td> <td>\$38.48</td> </tr> <tr> <td>100 +</td> <td>\$35.79</td> </tr> </tbody> </table> <p>Model No: PE9339 MHV Female To SHV Jack</p>	PRICE		1-24	\$44.74	25-49	\$41.61	50-99	\$38.48	100 +	\$35.79	SHV In-Series 		 <table border="1"> <thead> <tr> <th colspan="2">PRICE</th> </tr> </thead> <tbody> <tr> <td>1-24</td> <td>\$91.05</td> </tr> <tr> <td>25-49</td> <td>\$84.68</td> </tr> <tr> <td>50-99</td> <td>\$78.30</td> </tr> <tr> <td>100 +</td> <td>\$72.84</td> </tr> </tbody> </table> <p>Model No: PE9749 SHV Plug To SHV Jack</p>	PRICE		1-24	\$91.05	25-49	\$84.68	50-99	\$78.30	100 +	\$72.84																					
PRICE																																													
1-24	\$44.74																																												
25-49	\$41.61																																												
50-99	\$38.48																																												
100 +	\$35.79																																												
PRICE																																													
1-24	\$91.05																																												
25-49	\$84.68																																												
50-99	\$78.30																																												
100 +	\$72.84																																												
4	 <table border="1"> <thead> <tr> <th colspan="2">PRICE</th> </tr> </thead> <tbody> <tr> <td>1-24</td> <td>\$31.06</td> </tr> <tr> <td>25-49</td> <td>\$28.89</td> </tr> <tr> <td>50-99</td> <td>\$26.71</td> </tr> <tr> <td>100 +</td> <td>\$24.85</td> </tr> </tbody> </table> <p>Model No: PE9337 SHV Jack To SHV Jack</p>	PRICE		1-24	\$31.06	25-49	\$28.89	50-99	\$26.71	100 +	\$24.85	 <table border="1"> <thead> <tr> <th colspan="2">PRICE</th> </tr> </thead> <tbody> <tr> <td>1-24</td> <td>\$64.80</td> </tr> <tr> <td>25-49</td> <td>\$60.26</td> </tr> <tr> <td>50-99</td> <td>\$55.73</td> </tr> <tr> <td>100 +</td> <td>\$51.84</td> </tr> </tbody> </table> <p>Model No: PE9336 SHV Jack To SHV Jack Bulkhead Hermetically Sealed Mounting Hole B06</p>	PRICE		1-24	\$64.80	25-49	\$60.26	50-99	\$55.73	100 +	\$51.84	 <table border="1"> <thead> <tr> <th colspan="2">PRICE</th> </tr> </thead> <tbody> <tr> <td>1-24</td> <td>\$80.00</td> </tr> <tr> <td>25-49</td> <td>\$74.40</td> </tr> <tr> <td>50-99</td> <td>\$68.80</td> </tr> <tr> <td>100 +</td> <td>\$64.00</td> </tr> </tbody> </table> <p>Model No: PE9249 SHV "T" Jack-Plug-Jack</p>	PRICE		1-24	\$80.00	25-49	\$74.40	50-99	\$68.80	100 +	\$64.00	C In-Series 											
PRICE																																													
1-24	\$31.06																																												
25-49	\$28.89																																												
50-99	\$26.71																																												
100 +	\$24.85																																												
PRICE																																													
1-24	\$64.80																																												
25-49	\$60.26																																												
50-99	\$55.73																																												
100 +	\$51.84																																												
PRICE																																													
1-24	\$80.00																																												
25-49	\$74.40																																												
50-99	\$68.80																																												
100 +	\$64.00																																												
5	 <table border="1"> <thead> <tr> <th colspan="2">PRICE</th> </tr> </thead> <tbody> <tr> <td>1-24</td> <td>\$47.12</td> </tr> <tr> <td>25-49</td> <td>\$43.82</td> </tr> <tr> <td>50-99</td> <td>\$40.52</td> </tr> <tr> <td>100 +</td> <td>\$37.70</td> </tr> </tbody> </table> <p>Model No: PE9300 C Male To C Male</p>	PRICE		1-24	\$47.12	25-49	\$43.82	50-99	\$40.52	100 +	\$37.70	 <table border="1"> <thead> <tr> <th colspan="2">PRICE</th> </tr> </thead> <tbody> <tr> <td>1-24</td> <td>\$46.21</td> </tr> <tr> <td>25-49</td> <td>\$42.98</td> </tr> <tr> <td>50-99</td> <td>\$39.74</td> </tr> <tr> <td>100 +</td> <td>\$36.97</td> </tr> </tbody> </table> <p>Model No: PE9293 C Male To C Female Right Angle</p>	PRICE		1-24	\$46.21	25-49	\$42.98	50-99	\$39.74	100 +	\$36.97	 <table border="1"> <thead> <tr> <th colspan="2">PRICE</th> </tr> </thead> <tbody> <tr> <td>1-24</td> <td>\$33.79</td> </tr> <tr> <td>25-49</td> <td>\$31.42</td> </tr> <tr> <td>50-99</td> <td>\$29.06</td> </tr> <tr> <td>100 +</td> <td>\$27.03</td> </tr> </tbody> </table> <p>Model No: PE9208 C Female To C Female</p>	PRICE		1-24	\$33.79	25-49	\$31.42	50-99	\$29.06	100 +	\$27.03	 <table border="1"> <thead> <tr> <th colspan="2">PRICE</th> </tr> </thead> <tbody> <tr> <td>1-24</td> <td>\$70.68</td> </tr> <tr> <td>25-49</td> <td>\$65.73</td> </tr> <tr> <td>50-99</td> <td>\$60.78</td> </tr> <tr> <td>100 +</td> <td>\$56.54</td> </tr> </tbody> </table> <p>Model No: PE9186 C Female To C Female Bulkhead Mounting Hole B07</p>		PRICE		1-24	\$70.68	25-49	\$65.73	50-99	\$60.78	100 +	\$56.54
PRICE																																													
1-24	\$47.12																																												
25-49	\$43.82																																												
50-99	\$40.52																																												
100 +	\$37.70																																												
PRICE																																													
1-24	\$46.21																																												
25-49	\$42.98																																												
50-99	\$39.74																																												
100 +	\$36.97																																												
PRICE																																													
1-24	\$33.79																																												
25-49	\$31.42																																												
50-99	\$29.06																																												
100 +	\$27.03																																												
PRICE																																													
1-24	\$70.68																																												
25-49	\$65.73																																												
50-99	\$60.78																																												
100 +	\$56.54																																												
6	 <table border="1"> <thead> <tr> <th colspan="2">PRICE</th> </tr> </thead> <tbody> <tr> <td>1-24</td> <td>\$52.03</td> </tr> <tr> <td>25-49</td> <td>\$48.39</td> </tr> <tr> <td>50-99</td> <td>\$44.75</td> </tr> <tr> <td>100 +</td> <td>\$41.62</td> </tr> </tbody> </table> <p>Model No: PE9207 C "T" Female-Male-Female</p>	PRICE		1-24	\$52.03	25-49	\$48.39	50-99	\$44.75	100 +	\$41.62	 <table border="1"> <thead> <tr> <th colspan="2">PRICE</th> </tr> </thead> <tbody> <tr> <td>1-24</td> <td>\$70.68</td> </tr> <tr> <td>25-49</td> <td>\$65.73</td> </tr> <tr> <td>50-99</td> <td>\$60.78</td> </tr> <tr> <td>100 +</td> <td>\$56.54</td> </tr> </tbody> </table> <p>Model No: PE9294 C "T" Female-Female-Female</p>	PRICE		1-24	\$70.68	25-49	\$65.73	50-99	\$60.78	100 +	\$56.54	C Between-Series 		 <table border="1"> <thead> <tr> <th colspan="2">PRICE</th> </tr> </thead> <tbody> <tr> <td>1-24</td> <td>\$142.62</td> </tr> <tr> <td>25-49</td> <td>\$132.64</td> </tr> <tr> <td>50-99</td> <td>\$122.65</td> </tr> <tr> <td>100 +</td> <td>\$114.10</td> </tr> </tbody> </table> <p>Model No: PE9301 C Female To GR874</p>	PRICE		1-24	\$142.62	25-49	\$132.64	50-99	\$122.65	100 +	\$114.10										
PRICE																																													
1-24	\$52.03																																												
25-49	\$48.39																																												
50-99	\$44.75																																												
100 +	\$41.62																																												
PRICE																																													
1-24	\$70.68																																												
25-49	\$65.73																																												
50-99	\$60.78																																												
100 +	\$56.54																																												
PRICE																																													
1-24	\$142.62																																												
25-49	\$132.64																																												
50-99	\$122.65																																												
100 +	\$114.10																																												

ADAPTERS

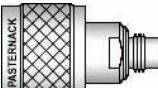
See Adapter Locator on Pages 140-145 or the Adapter Matrix on Pages 138-139

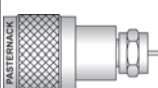
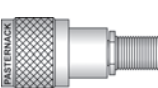
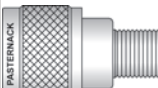
See Page 246 for Mounting Holes

	A	B	C	D																																								
1	<p>PAL In-Series</p> <p>→</p>	 <table border="1"> <thead> <tr> <th colspan="2">PRICE</th> </tr> </thead> <tbody> <tr> <td>1-24</td> <td>\$9.73</td> </tr> <tr> <td>25-49</td> <td>\$9.05</td> </tr> <tr> <td>50-99</td> <td>\$8.37</td> </tr> <tr> <td>100 +</td> <td>\$7.78</td> </tr> </tbody> </table> <p>Model No: PE9680 PAL Plug To PAL Plug</p>	PRICE		1-24	\$9.73	25-49	\$9.05	50-99	\$8.37	100 +	\$7.78	 <table border="1"> <thead> <tr> <th colspan="2">PRICE</th> </tr> </thead> <tbody> <tr> <td>1-24</td> <td>\$9.73</td> </tr> <tr> <td>25-49</td> <td>\$9.05</td> </tr> <tr> <td>50-99</td> <td>\$8.37</td> </tr> <tr> <td>100 +</td> <td>\$7.78</td> </tr> </tbody> </table> <p>Model No: PE9681 PAL Jack To PAL Jack</p>	PRICE		1-24	\$9.73	25-49	\$9.05	50-99	\$8.37	100 +	\$7.78	<p>75 Ohm N In-Series</p> <p>→</p>																				
PRICE																																												
1-24	\$9.73																																											
25-49	\$9.05																																											
50-99	\$8.37																																											
100 +	\$7.78																																											
PRICE																																												
1-24	\$9.73																																											
25-49	\$9.05																																											
50-99	\$8.37																																											
100 +	\$7.78																																											
2	 <table border="1"> <thead> <tr> <th colspan="2">PRICE</th> </tr> </thead> <tbody> <tr> <td>1-24</td> <td>\$22.95</td> </tr> <tr> <td>25-49</td> <td>\$21.34</td> </tr> <tr> <td>50-99</td> <td>\$19.74</td> </tr> <tr> <td>100 +</td> <td>\$18.36</td> </tr> </tbody> </table> <p>Model No: PE9308 75 Ohm N Male To 75 Ohm N Male</p>	PRICE		1-24	\$22.95	25-49	\$21.34	50-99	\$19.74	100 +	\$18.36	 <table border="1"> <thead> <tr> <th colspan="2">PRICE</th> </tr> </thead> <tbody> <tr> <td>1-24</td> <td>\$24.17</td> </tr> <tr> <td>25-49</td> <td>\$22.48</td> </tr> <tr> <td>50-99</td> <td>\$20.79</td> </tr> <tr> <td>100 +</td> <td>\$19.34</td> </tr> </tbody> </table> <p>Model No: PE9391 75 Ohm N Male To 75 Ohm N Female</p>	PRICE		1-24	\$24.17	25-49	\$22.48	50-99	\$20.79	100 +	\$19.34	 <table border="1"> <thead> <tr> <th colspan="2">PRICE</th> </tr> </thead> <tbody> <tr> <td>1-24</td> <td>\$31.36</td> </tr> <tr> <td>25-49</td> <td>\$29.16</td> </tr> <tr> <td>50-99</td> <td>\$26.97</td> </tr> <tr> <td>100 +</td> <td>\$25.09</td> </tr> </tbody> </table> <p>Model No: PE9307 75 Ohm N Male To 75 Ohm N Female Right Angle</p>	PRICE		1-24	\$31.36	25-49	\$29.16	50-99	\$26.97	100 +	\$25.09	 <table border="1"> <thead> <tr> <th colspan="2">PRICE</th> </tr> </thead> <tbody> <tr> <td>1-24</td> <td>\$22.95</td> </tr> <tr> <td>25-49</td> <td>\$21.34</td> </tr> <tr> <td>50-99</td> <td>\$19.74</td> </tr> <tr> <td>100 +</td> <td>\$18.36</td> </tr> </tbody> </table> <p>Model No: PE9306 75 Ohm N Female To 75 Ohm N Female</p>	PRICE		1-24	\$22.95	25-49	\$21.34	50-99	\$19.74	100 +	\$18.36
PRICE																																												
1-24	\$22.95																																											
25-49	\$21.34																																											
50-99	\$19.74																																											
100 +	\$18.36																																											
PRICE																																												
1-24	\$24.17																																											
25-49	\$22.48																																											
50-99	\$20.79																																											
100 +	\$19.34																																											
PRICE																																												
1-24	\$31.36																																											
25-49	\$29.16																																											
50-99	\$26.97																																											
100 +	\$25.09																																											
PRICE																																												
1-24	\$22.95																																											
25-49	\$21.34																																											
50-99	\$19.74																																											
100 +	\$18.36																																											
3	 <table border="1"> <thead> <tr> <th colspan="2">PRICE</th> </tr> </thead> <tbody> <tr> <td>1-24</td> <td>\$37.75</td> </tr> <tr> <td>25-49</td> <td>\$35.11</td> </tr> <tr> <td>50-99</td> <td>\$32.47</td> </tr> <tr> <td>100 +</td> <td>\$30.20</td> </tr> </tbody> </table> <p>Model No: PE9416 75 Ohm N Female To 75 Ohm N Female Bulkhead, Hermetically Sealed Mounting Hole G01</p>	PRICE		1-24	\$37.75	25-49	\$35.11	50-99	\$32.47	100 +	\$30.20	 <table border="1"> <thead> <tr> <th colspan="2">PRICE</th> </tr> </thead> <tbody> <tr> <td>1-24</td> <td>\$58.87</td> </tr> <tr> <td>25-49</td> <td>\$54.75</td> </tr> <tr> <td>50-99</td> <td>\$50.63</td> </tr> <tr> <td>100 +</td> <td>\$47.10</td> </tr> </tbody> </table> <p>Model No: PE9417 75 Ohm N Female To 75 Ohm N Female Bulkhead, Isolated Ground Mounting Hole G01</p>	PRICE		1-24	\$58.87	25-49	\$54.75	50-99	\$50.63	100 +	\$47.10	<p>75 Ohm N Between-Series</p> <p>→</p>	 <table border="1"> <thead> <tr> <th colspan="2">PRICE</th> </tr> </thead> <tbody> <tr> <td>1-24</td> <td>\$56.49</td> </tr> <tr> <td>25-49</td> <td>\$52.54</td> </tr> <tr> <td>50-99</td> <td>\$48.58</td> </tr> <tr> <td>100 +</td> <td>\$45.19</td> </tr> </tbody> </table> <p>Model No: PE9626 75 Ohm N Male To 75 Ohm TNC Male</p>	PRICE		1-24	\$56.49	25-49	\$52.54	50-99	\$48.58	100 +	\$45.19										
PRICE																																												
1-24	\$37.75																																											
25-49	\$35.11																																											
50-99	\$32.47																																											
100 +	\$30.20																																											
PRICE																																												
1-24	\$58.87																																											
25-49	\$54.75																																											
50-99	\$50.63																																											
100 +	\$47.10																																											
PRICE																																												
1-24	\$56.49																																											
25-49	\$52.54																																											
50-99	\$48.58																																											
100 +	\$45.19																																											
4	 <table border="1"> <thead> <tr> <th colspan="2">PRICE</th> </tr> </thead> <tbody> <tr> <td>1-24</td> <td>\$35.26</td> </tr> <tr> <td>25-49</td> <td>\$32.79</td> </tr> <tr> <td>50-99</td> <td>\$30.32</td> </tr> <tr> <td>100 +</td> <td>\$28.21</td> </tr> </tbody> </table> <p>Model No: PE9627 75 Ohm N Male To 75 Ohm TNC Female</p>	PRICE		1-24	\$35.26	25-49	\$32.79	50-99	\$30.32	100 +	\$28.21	 <table border="1"> <thead> <tr> <th colspan="2">PRICE</th> </tr> </thead> <tbody> <tr> <td>1-24</td> <td>\$35.26</td> </tr> <tr> <td>25-49</td> <td>\$32.79</td> </tr> <tr> <td>50-99</td> <td>\$30.32</td> </tr> <tr> <td>100 +</td> <td>\$28.21</td> </tr> </tbody> </table> <p>Model No: PE9628 75 Ohm N Female To 75 Ohm TNC Male</p>	PRICE		1-24	\$35.26	25-49	\$32.79	50-99	\$30.32	100 +	\$28.21	 <table border="1"> <thead> <tr> <th colspan="2">PRICE</th> </tr> </thead> <tbody> <tr> <td>1-24</td> <td>\$35.26</td> </tr> <tr> <td>25-49</td> <td>\$32.79</td> </tr> <tr> <td>50-99</td> <td>\$30.32</td> </tr> <tr> <td>100 +</td> <td>\$28.21</td> </tr> </tbody> </table> <p>Model No: PE9629 75 Ohm N Female To 75 Ohm TNC Female</p>	PRICE		1-24	\$35.26	25-49	\$32.79	50-99	\$30.32	100 +	\$28.21	 <table border="1"> <thead> <tr> <th colspan="2">PRICE</th> </tr> </thead> <tbody> <tr> <td>1-24</td> <td>\$70.68</td> </tr> <tr> <td>25-49</td> <td>\$65.73</td> </tr> <tr> <td>50-99</td> <td>\$60.78</td> </tr> <tr> <td>100 +</td> <td>\$56.54</td> </tr> </tbody> </table> <p>Model No: PE9588 75 Ohm N Male To 75 Ohm SMC Plug</p>	PRICE		1-24	\$70.68	25-49	\$65.73	50-99	\$60.78	100 +	\$56.54
PRICE																																												
1-24	\$35.26																																											
25-49	\$32.79																																											
50-99	\$30.32																																											
100 +	\$28.21																																											
PRICE																																												
1-24	\$35.26																																											
25-49	\$32.79																																											
50-99	\$30.32																																											
100 +	\$28.21																																											
PRICE																																												
1-24	\$35.26																																											
25-49	\$32.79																																											
50-99	\$30.32																																											
100 +	\$28.21																																											
PRICE																																												
1-24	\$70.68																																											
25-49	\$65.73																																											
50-99	\$60.78																																											
100 +	\$56.54																																											
5	 <table border="1"> <thead> <tr> <th colspan="2">PRICE</th> </tr> </thead> <tbody> <tr> <td>1-24</td> <td>\$65.16</td> </tr> <tr> <td>25-49</td> <td>\$60.60</td> </tr> <tr> <td>50-99</td> <td>\$56.04</td> </tr> <tr> <td>100 +</td> <td>\$52.13</td> </tr> </tbody> </table> <p>Model No: PE9586 75 Ohm N Male To 75 Ohm SMC Jack</p>	PRICE		1-24	\$65.16	25-49	\$60.60	50-99	\$56.04	100 +	\$52.13	 <table border="1"> <thead> <tr> <th colspan="2">PRICE</th> </tr> </thead> <tbody> <tr> <td>1-24</td> <td>\$70.68</td> </tr> <tr> <td>25-49</td> <td>\$65.73</td> </tr> <tr> <td>50-99</td> <td>\$60.78</td> </tr> <tr> <td>100 +</td> <td>\$56.54</td> </tr> </tbody> </table> <p>Model No: PE9589 75 Ohm N Female To 75 Ohm SMC Plug</p>	PRICE		1-24	\$70.68	25-49	\$65.73	50-99	\$60.78	100 +	\$56.54	 <table border="1"> <thead> <tr> <th colspan="2">PRICE</th> </tr> </thead> <tbody> <tr> <td>1-24</td> <td>\$65.16</td> </tr> <tr> <td>25-49</td> <td>\$60.60</td> </tr> <tr> <td>50-99</td> <td>\$56.04</td> </tr> <tr> <td>100 +</td> <td>\$52.13</td> </tr> </tbody> </table> <p>Model No: PE9587 75 Ohm N Female To 75 Ohm SMC Jack</p>	PRICE		1-24	\$65.16	25-49	\$60.60	50-99	\$56.04	100 +	\$52.13	 <table border="1"> <thead> <tr> <th colspan="2">PRICE</th> </tr> </thead> <tbody> <tr> <td>1-24</td> <td>\$70.93</td> </tr> <tr> <td>25-49</td> <td>\$65.96</td> </tr> <tr> <td>50-99</td> <td>\$61.00</td> </tr> <tr> <td>100 +</td> <td>\$56.74</td> </tr> </tbody> </table> <p>PRECISION Model No: PE9738 75 Ohm N Male To F Male Max VSWR 1.30:1 @ 3 GHz</p>	PRICE		1-24	\$70.93	25-49	\$65.96	50-99	\$61.00	100 +	\$56.74
PRICE																																												
1-24	\$65.16																																											
25-49	\$60.60																																											
50-99	\$56.04																																											
100 +	\$52.13																																											
PRICE																																												
1-24	\$70.68																																											
25-49	\$65.73																																											
50-99	\$60.78																																											
100 +	\$56.54																																											
PRICE																																												
1-24	\$65.16																																											
25-49	\$60.60																																											
50-99	\$56.04																																											
100 +	\$52.13																																											
PRICE																																												
1-24	\$70.93																																											
25-49	\$65.96																																											
50-99	\$61.00																																											
100 +	\$56.74																																											
6	 <table border="1"> <thead> <tr> <th colspan="2">PRICE</th> </tr> </thead> <tbody> <tr> <td>1-24</td> <td>\$87.55</td> </tr> <tr> <td>25-49</td> <td>\$81.42</td> </tr> <tr> <td>50-99</td> <td>\$75.29</td> </tr> <tr> <td>100 +</td> <td>\$70.04</td> </tr> </tbody> </table> <p>PRECISION Model No: PE9737 75 Ohm N Male To F Female Max VSWR 1.30:1 @ 3 GHz</p>	PRICE		1-24	\$87.55	25-49	\$81.42	50-99	\$75.29	100 +	\$70.04	 <table border="1"> <thead> <tr> <th colspan="2">PRICE</th> </tr> </thead> <tbody> <tr> <td>1-24</td> <td>\$30.37</td> </tr> <tr> <td>25-49</td> <td>\$28.24</td> </tr> <tr> <td>50-99</td> <td>\$26.12</td> </tr> <tr> <td>100 +</td> <td>\$24.30</td> </tr> </tbody> </table> <p>Model No: PE9396 75 Ohm N Male To F Female</p>	PRICE		1-24	\$30.37	25-49	\$28.24	50-99	\$26.12	100 +	\$24.30	 <table border="1"> <thead> <tr> <th colspan="2">PRICE</th> </tr> </thead> <tbody> <tr> <td>1-24</td> <td>\$69.41</td> </tr> <tr> <td>25-49</td> <td>\$64.55</td> </tr> <tr> <td>50-99</td> <td>\$59.69</td> </tr> <tr> <td>100 +</td> <td>\$55.53</td> </tr> </tbody> </table> <p>PRECISION Model No: PE9739 75 Ohm N Female To F Male Max VSWR 1.30:1 @ 3 GHz</p>	PRICE		1-24	\$69.41	25-49	\$64.55	50-99	\$59.69	100 +	\$55.53	 <table border="1"> <thead> <tr> <th colspan="2">PRICE</th> </tr> </thead> <tbody> <tr> <td>1-24</td> <td>\$35.31</td> </tr> <tr> <td>25-49</td> <td>\$32.84</td> </tr> <tr> <td>50-99</td> <td>\$30.37</td> </tr> <tr> <td>100 +</td> <td>\$28.25</td> </tr> </tbody> </table> <p>Model No: PE9397 75 Ohm N Female To F Male</p>	PRICE		1-24	\$35.31	25-49	\$32.84	50-99	\$30.37	100 +	\$28.25
PRICE																																												
1-24	\$87.55																																											
25-49	\$81.42																																											
50-99	\$75.29																																											
100 +	\$70.04																																											
PRICE																																												
1-24	\$30.37																																											
25-49	\$28.24																																											
50-99	\$26.12																																											
100 +	\$24.30																																											
PRICE																																												
1-24	\$69.41																																											
25-49	\$64.55																																											
50-99	\$59.69																																											
100 +	\$55.53																																											
PRICE																																												
1-24	\$35.31																																											
25-49	\$32.84																																											
50-99	\$30.37																																											
100 +	\$28.25																																											



Free Freight Available
via UPS Ground
to USA & Canada



Real-Time Stock
Levels & Pricing
On Our Website



Toll-Free Technical
Support
(866) 727-8376



Same-Day Shipping,
Even Custom
Cable Assemblies











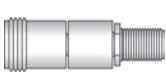



ADAPTERS

See Adapter Locator on Pages 140-145 or the Adapter Matrix on Pages 138-139

See Page 246 for Mounting Holes

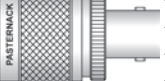
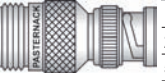
Adapters



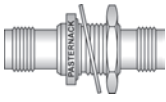
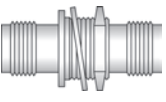
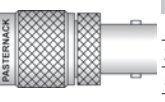
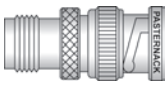
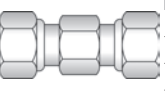
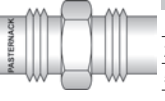







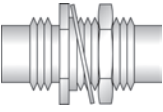

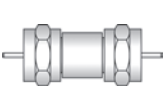

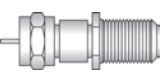
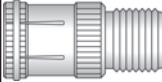

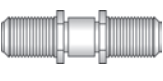
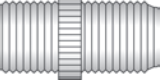
See Our Website For Real-Time Stock Availability!

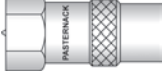
	A	B	C	D																																								
1	 <table border="1"> <thead> <tr> <th colspan="2">PRICE</th> </tr> </thead> <tbody> <tr> <td>1-24</td> <td>\$91.15</td> </tr> <tr> <td>25-49</td> <td>\$84.77</td> </tr> <tr> <td>50-99</td> <td>\$78.39</td> </tr> <tr> <td>100 +</td> <td>\$72.92</td> </tr> </tbody> </table> <p>Model No: PE9740 75 Ohm N Female To F Female Max VSWR 1.30:1 @ 3 GHz</p>	PRICE		1-24	\$91.15	25-49	\$84.77	50-99	\$78.39	100 +	\$72.92	 <table border="1"> <thead> <tr> <th colspan="2">PRICE</th> </tr> </thead> <tbody> <tr> <td>1-24</td> <td>\$70.68</td> </tr> <tr> <td>25-49</td> <td>\$65.73</td> </tr> <tr> <td>50-99</td> <td>\$60.78</td> </tr> <tr> <td>100 +</td> <td>\$56.54</td> </tr> </tbody> </table> <p>Model No: PE9584 75 Ohm N Male To 75 Ohm SMB Plug</p>	PRICE		1-24	\$70.68	25-49	\$65.73	50-99	\$60.78	100 +	\$56.54	 <table border="1"> <thead> <tr> <th colspan="2">PRICE</th> </tr> </thead> <tbody> <tr> <td>1-24</td> <td>\$62.37</td> </tr> <tr> <td>25-49</td> <td>\$58.00</td> </tr> <tr> <td>50-99</td> <td>\$53.64</td> </tr> <tr> <td>100 +</td> <td>\$49.90</td> </tr> </tbody> </table> <p>Model No: PE9582 75 Ohm N Male To 75 Ohm SMB Jack</p>	PRICE		1-24	\$62.37	25-49	\$58.00	50-99	\$53.64	100 +	\$49.90	 <table border="1"> <thead> <tr> <th colspan="2">PRICE</th> </tr> </thead> <tbody> <tr> <td>1-24</td> <td>\$70.68</td> </tr> <tr> <td>25-49</td> <td>\$65.73</td> </tr> <tr> <td>50-99</td> <td>\$60.78</td> </tr> <tr> <td>100 +</td> <td>\$56.54</td> </tr> </tbody> </table> <p>Model No: PE9585 75 Ohm N Female To 75 Ohm SMB Jack</p>	PRICE		1-24	\$70.68	25-49	\$65.73	50-99	\$60.78	100 +	\$56.54
PRICE																																												
1-24	\$91.15																																											
25-49	\$84.77																																											
50-99	\$78.39																																											
100 +	\$72.92																																											
PRICE																																												
1-24	\$70.68																																											
25-49	\$65.73																																											
50-99	\$60.78																																											
100 +	\$56.54																																											
PRICE																																												
1-24	\$62.37																																											
25-49	\$58.00																																											
50-99	\$53.64																																											
100 +	\$49.90																																											
PRICE																																												
1-24	\$70.68																																											
25-49	\$65.73																																											
50-99	\$60.78																																											
100 +	\$56.54																																											
2	 <table border="1"> <thead> <tr> <th colspan="2">PRICE</th> </tr> </thead> <tbody> <tr> <td>1-24</td> <td>\$70.68</td> </tr> <tr> <td>25-49</td> <td>\$65.73</td> </tr> <tr> <td>50-99</td> <td>\$60.78</td> </tr> <tr> <td>100 +</td> <td>\$56.54</td> </tr> </tbody> </table> <p>Model No: PE9583 75 Ohm N Female To 75 Ohm SMB Jack</p>	PRICE		1-24	\$70.68	25-49	\$65.73	50-99	\$60.78	100 +	\$56.54	 <table border="1"> <thead> <tr> <th colspan="2">PRICE</th> </tr> </thead> <tbody> <tr> <td>1-24</td> <td>\$58.87</td> </tr> <tr> <td>25-49</td> <td>\$54.75</td> </tr> <tr> <td>50-99</td> <td>\$50.63</td> </tr> <tr> <td>100 +</td> <td>\$47.10</td> </tr> </tbody> </table> <p>Model No: PE9612 75 Ohm N Male To Mini 75 Ohm SMB Plug</p>	PRICE		1-24	\$58.87	25-49	\$54.75	50-99	\$50.63	100 +	\$47.10	 <table border="1"> <thead> <tr> <th colspan="2">PRICE</th> </tr> </thead> <tbody> <tr> <td>1-24</td> <td>\$57.81</td> </tr> <tr> <td>25-49</td> <td>\$53.76</td> </tr> <tr> <td>50-99</td> <td>\$49.72</td> </tr> <tr> <td>100 +</td> <td>\$46.25</td> </tr> </tbody> </table> <p>Model No: PE9614 75 Ohm N Male To Mini 75 Ohm SMB Jack</p>	PRICE		1-24	\$57.81	25-49	\$53.76	50-99	\$49.72	100 +	\$46.25	 <table border="1"> <thead> <tr> <th colspan="2">PRICE</th> </tr> </thead> <tbody> <tr> <td>1-24</td> <td>\$82.33</td> </tr> <tr> <td>25-49</td> <td>\$76.57</td> </tr> <tr> <td>50-99</td> <td>\$70.80</td> </tr> <tr> <td>100 +</td> <td>\$65.86</td> </tr> </tbody> </table> <p>Model No: PE9613 75 Ohm N Female To Mini 75 Ohm SMB Plug</p>	PRICE		1-24	\$82.33	25-49	\$76.57	50-99	\$70.80	100 +	\$65.86
PRICE																																												
1-24	\$70.68																																											
25-49	\$65.73																																											
50-99	\$60.78																																											
100 +	\$56.54																																											
PRICE																																												
1-24	\$58.87																																											
25-49	\$54.75																																											
50-99	\$50.63																																											
100 +	\$47.10																																											
PRICE																																												
1-24	\$57.81																																											
25-49	\$53.76																																											
50-99	\$49.72																																											
100 +	\$46.25																																											
PRICE																																												
1-24	\$82.33																																											
25-49	\$76.57																																											
50-99	\$70.80																																											
100 +	\$65.86																																											
3	 <table border="1"> <thead> <tr> <th colspan="2">PRICE</th> </tr> </thead> <tbody> <tr> <td>1-24</td> <td>\$58.87</td> </tr> <tr> <td>25-49</td> <td>\$54.75</td> </tr> <tr> <td>50-99</td> <td>\$50.63</td> </tr> <tr> <td>100 +</td> <td>\$47.10</td> </tr> </tbody> </table> <p>Model No: PE9615 75 Ohm N Female To Mini 75 Ohm SMB Jack</p>	PRICE		1-24	\$58.87	25-49	\$54.75	50-99	\$50.63	100 +	\$47.10	 <table border="1"> <thead> <tr> <th colspan="2">PRICE</th> </tr> </thead> <tbody> <tr> <td>1-24</td> <td>\$46.71</td> </tr> <tr> <td>25-49</td> <td>\$43.44</td> </tr> <tr> <td>50-99</td> <td>\$40.17</td> </tr> <tr> <td>100 +</td> <td>\$37.37</td> </tr> </tbody> </table> <p>Model No: PE9370 75 Ohm N Male To 75 Ohm BNC Male Mates With 50 Ohm BNC</p>	PRICE		1-24	\$46.71	25-49	\$43.44	50-99	\$40.17	100 +	\$37.37	 <table border="1"> <thead> <tr> <th colspan="2">PRICE</th> </tr> </thead> <tbody> <tr> <td>1-24</td> <td>\$23.46</td> </tr> <tr> <td>25-49</td> <td>\$21.82</td> </tr> <tr> <td>50-99</td> <td>\$20.18</td> </tr> <tr> <td>100 +</td> <td>\$18.77</td> </tr> </tbody> </table> <p>Model No: PE9369 75 Ohm N Male To 75 Ohm BNC Female Mates With 50 Ohm BNC</p>	PRICE		1-24	\$23.46	25-49	\$21.82	50-99	\$20.18	100 +	\$18.77	 <table border="1"> <thead> <tr> <th colspan="2">PRICE</th> </tr> </thead> <tbody> <tr> <td>1-24</td> <td>\$22.95</td> </tr> <tr> <td>25-49</td> <td>\$21.34</td> </tr> <tr> <td>50-99</td> <td>\$19.74</td> </tr> <tr> <td>100 +</td> <td>\$18.36</td> </tr> </tbody> </table> <p>Model No: PE9368 75 Ohm N Female To 75 Ohm BNC Male Mates With 50 Ohm BNC</p>	PRICE		1-24	\$22.95	25-49	\$21.34	50-99	\$19.74	100 +	\$18.36
PRICE																																												
1-24	\$58.87																																											
25-49	\$54.75																																											
50-99	\$50.63																																											
100 +	\$47.10																																											
PRICE																																												
1-24	\$46.71																																											
25-49	\$43.44																																											
50-99	\$40.17																																											
100 +	\$37.37																																											
PRICE																																												
1-24	\$23.46																																											
25-49	\$21.82																																											
50-99	\$20.18																																											
100 +	\$18.77																																											
PRICE																																												
1-24	\$22.95																																											
25-49	\$21.34																																											
50-99	\$19.74																																											
100 +	\$18.36																																											
4	 <table border="1"> <thead> <tr> <th colspan="2">PRICE</th> </tr> </thead> <tbody> <tr> <td>1-24</td> <td>\$66.98</td> </tr> <tr> <td>25-49</td> <td>\$62.29</td> </tr> <tr> <td>50-99</td> <td>\$57.60</td> </tr> <tr> <td>100 +</td> <td>\$53.58</td> </tr> </tbody> </table> <p>Model No: PE9371 75 Ohm N Female To 75 Ohm BNC Female Mates With 50 Ohm BNC</p>	PRICE		1-24	\$66.98	25-49	\$62.29	50-99	\$57.60	100 +	\$53.58	<p>75 Ohm TNC In-Series</p> <p>→</p>		 <table border="1"> <thead> <tr> <th colspan="2">PRICE</th> </tr> </thead> <tbody> <tr> <td>1-24</td> <td>\$52.94</td> </tr> <tr> <td>25-49</td> <td>\$49.23</td> </tr> <tr> <td>50-99</td> <td>\$45.53</td> </tr> <tr> <td>100 +</td> <td>\$42.35</td> </tr> </tbody> </table> <p>Model No: PE9623 75 Ohm TNC Male To 75 Ohm TNC Female Right Angle</p>	PRICE		1-24	\$52.94	25-49	\$49.23	50-99	\$45.53	100 +	\$42.35	 <table border="1"> <thead> <tr> <th colspan="2">PRICE</th> </tr> </thead> <tbody> <tr> <td>1-24</td> <td>\$23.51</td> </tr> <tr> <td>25-49</td> <td>\$21.86</td> </tr> <tr> <td>50-99</td> <td>\$20.22</td> </tr> <tr> <td>100 +</td> <td>\$18.81</td> </tr> </tbody> </table> <p>Model No: PE9622 75 Ohm TNC Female To 75 Ohm TNC Female</p>	PRICE		1-24	\$23.51	25-49	\$21.86	50-99	\$20.22	100 +	\$18.81									
PRICE																																												
1-24	\$66.98																																											
25-49	\$62.29																																											
50-99	\$57.60																																											
100 +	\$53.58																																											
PRICE																																												
1-24	\$52.94																																											
25-49	\$49.23																																											
50-99	\$45.53																																											
100 +	\$42.35																																											
PRICE																																												
1-24	\$23.51																																											
25-49	\$21.86																																											
50-99	\$20.22																																											
100 +	\$18.81																																											
5	 <table border="1"> <thead> <tr> <th colspan="2">PRICE</th> </tr> </thead> <tbody> <tr> <td>1-24</td> <td>\$57.81</td> </tr> <tr> <td>25-49</td> <td>\$53.76</td> </tr> <tr> <td>50-99</td> <td>\$49.72</td> </tr> <tr> <td>100 +</td> <td>\$46.25</td> </tr> </tbody> </table> <p>Model No: PE9624 75 Ohm TNC Female To 75 Ohm TNC Female Bulkhead, Hermetically Sealed Mounting Hole B06</p>	PRICE		1-24	\$57.81	25-49	\$53.76	50-99	\$49.72	100 +	\$46.25	 <table border="1"> <thead> <tr> <th colspan="2">PRICE</th> </tr> </thead> <tbody> <tr> <td>1-24</td> <td>\$35.26</td> </tr> <tr> <td>25-49</td> <td>\$32.79</td> </tr> <tr> <td>50-99</td> <td>\$30.32</td> </tr> <tr> <td>100 +</td> <td>\$28.21</td> </tr> </tbody> </table> <p>Model No: PE9625 75 Ohm TNC Female To 75 Ohm TNC Female Bulkhead, Isolated Ground Mounting Hole B06</p>	PRICE		1-24	\$35.26	25-49	\$32.79	50-99	\$30.32	100 +	\$28.21	<p>75 Ohm TNC Between-Series</p> <p>→</p>		 <table border="1"> <thead> <tr> <th colspan="2">PRICE</th> </tr> </thead> <tbody> <tr> <td>1-24</td> <td>\$16.87</td> </tr> <tr> <td>25-49</td> <td>\$15.69</td> </tr> <tr> <td>50-99</td> <td>\$14.51</td> </tr> <tr> <td>100 +</td> <td>\$13.50</td> </tr> </tbody> </table> <p>Model No: PE9631 75 Ohm TNC Male To 75 Ohm BNC Female</p>	PRICE		1-24	\$16.87	25-49	\$15.69	50-99	\$14.51	100 +	\$13.50									
PRICE																																												
1-24	\$57.81																																											
25-49	\$53.76																																											
50-99	\$49.72																																											
100 +	\$46.25																																											
PRICE																																												
1-24	\$35.26																																											
25-49	\$32.79																																											
50-99	\$30.32																																											
100 +	\$28.21																																											
PRICE																																												
1-24	\$16.87																																											
25-49	\$15.69																																											
50-99	\$14.51																																											
100 +	\$13.50																																											
6	 <table border="1"> <thead> <tr> <th colspan="2">PRICE</th> </tr> </thead> <tbody> <tr> <td>1-24</td> <td>\$35.26</td> </tr> <tr> <td>25-49</td> <td>\$32.79</td> </tr> <tr> <td>50-99</td> <td>\$30.32</td> </tr> <tr> <td>100 +</td> <td>\$28.21</td> </tr> </tbody> </table> <p>Model No: PE9630 75 Ohm TNC Female To 75 Ohm BNC Male</p>	PRICE		1-24	\$35.26	25-49	\$32.79	50-99	\$30.32	100 +	\$28.21	<p>75 Ohm SMC In-Series</p> <p>→</p>		 <table border="1"> <thead> <tr> <th colspan="2">PRICE</th> </tr> </thead> <tbody> <tr> <td>1-24</td> <td>\$31.92</td> </tr> <tr> <td>25-49</td> <td>\$29.69</td> </tr> <tr> <td>50-99</td> <td>\$27.45</td> </tr> <tr> <td>100 +</td> <td>\$25.54</td> </tr> </tbody> </table> <p>Model No: PE9272 75 Ohm SMC Plug To 75 Ohm SMC Plug</p>	PRICE		1-24	\$31.92	25-49	\$29.69	50-99	\$27.45	100 +	\$25.54	 <table border="1"> <thead> <tr> <th colspan="2">PRICE</th> </tr> </thead> <tbody> <tr> <td>1-24</td> <td>\$28.22</td> </tr> <tr> <td>25-49</td> <td>\$26.24</td> </tr> <tr> <td>50-99</td> <td>\$24.27</td> </tr> <tr> <td>100 +</td> <td>\$22.58</td> </tr> </tbody> </table> <p>Model No: PE9277 75 Ohm SMC Jack To 75 Ohm SMC Jack</p>	PRICE		1-24	\$28.22	25-49	\$26.24	50-99	\$24.27	100 +	\$22.58									
PRICE																																												
1-24	\$35.26																																											
25-49	\$32.79																																											
50-99	\$30.32																																											
100 +	\$28.21																																											
PRICE																																												
1-24	\$31.92																																											
25-49	\$29.69																																											
50-99	\$27.45																																											
100 +	\$25.54																																											
PRICE																																												
1-24	\$28.22																																											
25-49	\$26.24																																											
50-99	\$24.27																																											
100 +	\$22.58																																											

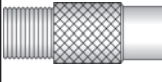
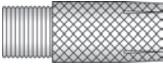
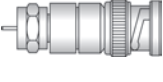
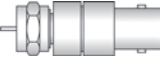
ADAPTERS

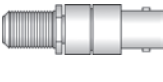
See Adapter Locator on Pages 140-145 or the Adapter Matrix on Pages 138-139

See Page 246 for Mounting Holes

	A	B	C	D																																								
1	 <table border="1"> <thead> <tr> <th colspan="2">PRICE</th> </tr> </thead> <tbody> <tr> <td>1-24</td> <td>\$35.26</td> </tr> <tr> <td>25-49</td> <td>\$32.79</td> </tr> <tr> <td>50-99</td> <td>\$30.32</td> </tr> <tr> <td>100 +</td> <td>\$28.21</td> </tr> </tbody> </table> <p>Model No: PE9228 75 Ohm SMC Jack To 75 Ohm SMC Jack Bulkhead Mounting Hole B03</p>	PRICE		1-24	\$35.26	25-49	\$32.79	50-99	\$30.32	100 +	\$28.21	 <table border="1"> <thead> <tr> <th colspan="2">PRICE</th> </tr> </thead> <tbody> <tr> <td>1-24</td> <td>\$52.94</td> </tr> <tr> <td>25-49</td> <td>\$49.23</td> </tr> <tr> <td>50-99</td> <td>\$45.53</td> </tr> <tr> <td>100 +</td> <td>\$42.35</td> </tr> </tbody> </table> <p>Model No: PE9244 75 Ohm SMC "T" Jack-Plug-Jack</p>	PRICE		1-24	\$52.94	25-49	\$49.23	50-99	\$45.53	100 +	\$42.35	<p>75 Ohm F In-Series</p> <p>→</p>		 <table border="1"> <thead> <tr> <th colspan="2">PRICE</th> </tr> </thead> <tbody> <tr> <td>1-24</td> <td>\$52.94</td> </tr> <tr> <td>25-49</td> <td>\$49.23</td> </tr> <tr> <td>50-99</td> <td>\$45.53</td> </tr> <tr> <td>100 +</td> <td>\$42.35</td> </tr> </tbody> </table> <p>PRECISION Model No: PE9760 F Male To F Male Max VSWR 1.30:1 @ 3 GHz</p>	PRICE		1-24	\$52.94	25-49	\$49.23	50-99	\$45.53	100 +	\$42.35									
	PRICE																																											
1-24	\$35.26																																											
25-49	\$32.79																																											
50-99	\$30.32																																											
100 +	\$28.21																																											
PRICE																																												
1-24	\$52.94																																											
25-49	\$49.23																																											
50-99	\$45.53																																											
100 +	\$42.35																																											
PRICE																																												
1-24	\$52.94																																											
25-49	\$49.23																																											
50-99	\$45.53																																											
100 +	\$42.35																																											
2	 <table border="1"> <thead> <tr> <th colspan="2">PRICE</th> </tr> </thead> <tbody> <tr> <td>1-24</td> <td>\$10.84</td> </tr> <tr> <td>25-49</td> <td>\$10.08</td> </tr> <tr> <td>50-99</td> <td>\$9.32</td> </tr> <tr> <td>100 +</td> <td>\$8.67</td> </tr> </tbody> </table> <p>Model No: PE9159 F Male To F Male</p>	PRICE		1-24	\$10.84	25-49	\$10.08	50-99	\$9.32	100 +	\$8.67	 <table border="1"> <thead> <tr> <th colspan="2">PRICE</th> </tr> </thead> <tbody> <tr> <td>1-24</td> <td>\$52.94</td> </tr> <tr> <td>25-49</td> <td>\$49.23</td> </tr> <tr> <td>50-99</td> <td>\$45.53</td> </tr> <tr> <td>100 +</td> <td>\$42.35</td> </tr> </tbody> </table> <p>PRECISION Model No: PE9759 F Male To F Female Max VSWR 1.30:1 @ 3 GHz</p>	PRICE		1-24	\$52.94	25-49	\$49.23	50-99	\$45.53	100 +	\$42.35	 <table border="1"> <thead> <tr> <th colspan="2">PRICE</th> </tr> </thead> <tbody> <tr> <td>1-24</td> <td>\$10.84</td> </tr> <tr> <td>25-49</td> <td>\$10.08</td> </tr> <tr> <td>50-99</td> <td>\$9.32</td> </tr> <tr> <td>100 +</td> <td>\$8.67</td> </tr> </tbody> </table> <p>Model No: PE9160 F Male Push On To F Female</p>	PRICE		1-24	\$10.84	25-49	\$10.08	50-99	\$9.32	100 +	\$8.67	 <table border="1"> <thead> <tr> <th colspan="2">PRICE</th> </tr> </thead> <tbody> <tr> <td>1-24</td> <td>\$9.58</td> </tr> <tr> <td>25-49</td> <td>\$8.91</td> </tr> <tr> <td>50-99</td> <td>\$8.24</td> </tr> <tr> <td>100 +</td> <td>\$7.66</td> </tr> </tbody> </table> <p>Model No: PE9166 F Male To F Female Right Angle</p>	PRICE		1-24	\$9.58	25-49	\$8.91	50-99	\$8.24	100 +	\$7.66
	PRICE																																											
1-24	\$10.84																																											
25-49	\$10.08																																											
50-99	\$9.32																																											
100 +	\$8.67																																											
PRICE																																												
1-24	\$52.94																																											
25-49	\$49.23																																											
50-99	\$45.53																																											
100 +	\$42.35																																											
PRICE																																												
1-24	\$10.84																																											
25-49	\$10.08																																											
50-99	\$9.32																																											
100 +	\$8.67																																											
PRICE																																												
1-24	\$9.58																																											
25-49	\$8.91																																											
50-99	\$8.24																																											
100 +	\$7.66																																											
3	 <table border="1"> <thead> <tr> <th colspan="2">PRICE</th> </tr> </thead> <tbody> <tr> <td>1-24</td> <td>\$52.03</td> </tr> <tr> <td>25-49</td> <td>\$48.39</td> </tr> <tr> <td>50-99</td> <td>\$44.75</td> </tr> <tr> <td>100 +</td> <td>\$41.62</td> </tr> </tbody> </table> <p>PRECISION Model No: PE9761 F Female To F Female Max VSWR 1.30:1 @ 3 GHz</p>	PRICE		1-24	\$52.03	25-49	\$48.39	50-99	\$44.75	100 +	\$41.62	 <table border="1"> <thead> <tr> <th colspan="2">PRICE</th> </tr> </thead> <tbody> <tr> <td>1-24</td> <td>\$5.04</td> </tr> <tr> <td>25-49</td> <td>\$4.69</td> </tr> <tr> <td>50-99</td> <td>\$4.33</td> </tr> <tr> <td>100 +</td> <td>\$4.03</td> </tr> </tbody> </table> <p>Model No: PE9164 F Female To F Female</p>	PRICE		1-24	\$5.04	25-49	\$4.69	50-99	\$4.33	100 +	\$4.03	 <table border="1"> <thead> <tr> <th colspan="2">PRICE</th> </tr> </thead> <tbody> <tr> <td>1-24</td> <td>\$11.86</td> </tr> <tr> <td>25-49</td> <td>\$11.03</td> </tr> <tr> <td>50-99</td> <td>\$10.20</td> </tr> <tr> <td>100 +</td> <td>\$9.49</td> </tr> </tbody> </table> <p>Model No: PE9734 F Female To F Female Bulkhead Mounting Hole B04</p>	PRICE		1-24	\$11.86	25-49	\$11.03	50-99	\$10.20	100 +	\$9.49	<p>75 Ohm F Between-Series</p> <p>→</p>										
	PRICE																																											
1-24	\$52.03																																											
25-49	\$48.39																																											
50-99	\$44.75																																											
100 +	\$41.62																																											
PRICE																																												
1-24	\$5.04																																											
25-49	\$4.69																																											
50-99	\$4.33																																											
100 +	\$4.03																																											
PRICE																																												
1-24	\$11.86																																											
25-49	\$11.03																																											
50-99	\$10.20																																											
100 +	\$9.49																																											
4	 <table border="1"> <thead> <tr> <th colspan="2">PRICE</th> </tr> </thead> <tbody> <tr> <td>1-24</td> <td>\$10.59</td> </tr> <tr> <td>25-49</td> <td>\$9.85</td> </tr> <tr> <td>50-99</td> <td>\$9.11</td> </tr> <tr> <td>100 +</td> <td>\$8.47</td> </tr> </tbody> </table> <p>Model No: PE9633 F Male To PAL Plug</p>	PRICE		1-24	\$10.59	25-49	\$9.85	50-99	\$9.11	100 +	\$8.47	 <table border="1"> <thead> <tr> <th colspan="2">PRICE</th> </tr> </thead> <tbody> <tr> <td>1-24</td> <td>\$10.59</td> </tr> <tr> <td>25-49</td> <td>\$9.85</td> </tr> <tr> <td>50-99</td> <td>\$9.11</td> </tr> <tr> <td>100 +</td> <td>\$8.47</td> </tr> </tbody> </table> <p>Model No: PE9632 F Male To PAL Jack</p>	PRICE		1-24	\$10.59	25-49	\$9.85	50-99	\$9.11	100 +	\$8.47	 <table border="1"> <thead> <tr> <th colspan="2">PRICE</th> </tr> </thead> <tbody> <tr> <td>1-24</td> <td>\$9.58</td> </tr> <tr> <td>25-49</td> <td>\$8.91</td> </tr> <tr> <td>50-99</td> <td>\$8.24</td> </tr> <tr> <td>100 +</td> <td>\$7.66</td> </tr> </tbody> </table> <p>Model No: PE9635 F Female To PAL Plug</p>	PRICE		1-24	\$9.58	25-49	\$8.91	50-99	\$8.24	100 +	\$7.66	 <table border="1"> <thead> <tr> <th colspan="2">PRICE</th> </tr> </thead> <tbody> <tr> <td>1-24</td> <td>\$10.59</td> </tr> <tr> <td>25-49</td> <td>\$9.85</td> </tr> <tr> <td>50-99</td> <td>\$9.11</td> </tr> <tr> <td>100 +</td> <td>\$8.47</td> </tr> </tbody> </table> <p>Model No: PE9634 F Female To PAL Jack</p>	PRICE		1-24	\$10.59	25-49	\$9.85	50-99	\$9.11	100 +	\$8.47
	PRICE																																											
1-24	\$10.59																																											
25-49	\$9.85																																											
50-99	\$9.11																																											
100 +	\$8.47																																											
PRICE																																												
1-24	\$10.59																																											
25-49	\$9.85																																											
50-99	\$9.11																																											
100 +	\$8.47																																											
PRICE																																												
1-24	\$9.58																																											
25-49	\$8.91																																											
50-99	\$8.24																																											
100 +	\$7.66																																											
PRICE																																												
1-24	\$10.59																																											
25-49	\$9.85																																											
50-99	\$9.11																																											
100 +	\$8.47																																											
5	 <table border="1"> <thead> <tr> <th colspan="2">PRICE</th> </tr> </thead> <tbody> <tr> <td>1-24</td> <td>\$70.68</td> </tr> <tr> <td>25-49</td> <td>\$65.73</td> </tr> <tr> <td>50-99</td> <td>\$60.78</td> </tr> <tr> <td>100 +</td> <td>\$56.54</td> </tr> </tbody> </table> <p>PRECISION Model No: PE9742 F Male To 75 Ohm BNC Male Max VSWR 1.30:1 @ 3 GHz</p>	PRICE		1-24	\$70.68	25-49	\$65.73	50-99	\$60.78	100 +	\$56.54	 <table border="1"> <thead> <tr> <th colspan="2">PRICE</th> </tr> </thead> <tbody> <tr> <td>1-24</td> <td>\$80.96</td> </tr> <tr> <td>25-49</td> <td>\$75.29</td> </tr> <tr> <td>50-99</td> <td>\$69.63</td> </tr> <tr> <td>100 +</td> <td>\$64.77</td> </tr> </tbody> </table> <p>PRECISION Model No: PE9743 F Male To 75 Ohm BNC Female Max VSWR 1.30:1 @ 3 GHz</p>	PRICE		1-24	\$80.96	25-49	\$75.29	50-99	\$69.63	100 +	\$64.77	 <table border="1"> <thead> <tr> <th colspan="2">PRICE</th> </tr> </thead> <tbody> <tr> <td>1-24</td> <td>\$80.96</td> </tr> <tr> <td>25-49</td> <td>\$75.29</td> </tr> <tr> <td>50-99</td> <td>\$69.63</td> </tr> <tr> <td>100 +</td> <td>\$64.77</td> </tr> </tbody> </table> <p>PRECISION Model No: PE9741 F Female To 75 Ohm BNC Male Max VSWR 1.30:1 @ 3 GHz</p>	PRICE		1-24	\$80.96	25-49	\$75.29	50-99	\$69.63	100 +	\$64.77	 <table border="1"> <thead> <tr> <th colspan="2">PRICE</th> </tr> </thead> <tbody> <tr> <td>1-24</td> <td>\$83.24</td> </tr> <tr> <td>25-49</td> <td>\$77.41</td> </tr> <tr> <td>50-99</td> <td>\$71.59</td> </tr> <tr> <td>100 +</td> <td>\$66.59</td> </tr> </tbody> </table> <p>PRECISION Model No: PE9744 F Female To 75 Ohm BNC Female Max VSWR 1.30:1 @ 3 GHz</p>	PRICE		1-24	\$83.24	25-49	\$77.41	50-99	\$71.59	100 +	\$66.59
	PRICE																																											
1-24	\$70.68																																											
25-49	\$65.73																																											
50-99	\$60.78																																											
100 +	\$56.54																																											
PRICE																																												
1-24	\$80.96																																											
25-49	\$75.29																																											
50-99	\$69.63																																											
100 +	\$64.77																																											
PRICE																																												
1-24	\$80.96																																											
25-49	\$75.29																																											
50-99	\$69.63																																											
100 +	\$64.77																																											
PRICE																																												
1-24	\$83.24																																											
25-49	\$77.41																																											
50-99	\$71.59																																											
100 +	\$66.59																																											
6	 <table border="1"> <thead> <tr> <th colspan="2">PRICE</th> </tr> </thead> <tbody> <tr> <td>1-24</td> <td>\$11.80</td> </tr> <tr> <td>25-49</td> <td>\$10.97</td> </tr> <tr> <td>50-99</td> <td>\$10.15</td> </tr> <tr> <td>100 +</td> <td>\$9.44</td> </tr> </tbody> </table> <p>Model No: PE9163 F Female To RCA Plug</p>	PRICE		1-24	\$11.80	25-49	\$10.97	50-99	\$10.15	100 +	\$9.44	 <table border="1"> <thead> <tr> <th colspan="2">PRICE</th> </tr> </thead> <tbody> <tr> <td>1-24</td> <td>\$10.99</td> </tr> <tr> <td>25-49</td> <td>\$10.22</td> </tr> <tr> <td>50-99</td> <td>\$9.45</td> </tr> <tr> <td>100 +</td> <td>\$8.79</td> </tr> </tbody> </table> <p>Model No: PE9168 F Female To RCA Jack</p>	PRICE		1-24	\$10.99	25-49	\$10.22	50-99	\$9.45	100 +	\$8.79	<p>75 Ohm SMB In-Series</p> <p>→</p>		 <table border="1"> <thead> <tr> <th colspan="2">PRICE</th> </tr> </thead> <tbody> <tr> <td>1-24</td> <td>\$44.23</td> </tr> <tr> <td>25-49</td> <td>\$41.13</td> </tr> <tr> <td>50-99</td> <td>\$38.04</td> </tr> <tr> <td>100 +</td> <td>\$35.38</td> </tr> </tbody> </table> <p>Model No: PE9271 75 Ohm SMB Plug To 75 Ohm SMB Plug</p>	PRICE		1-24	\$44.23	25-49	\$41.13	50-99	\$38.04	100 +	\$35.38									
	PRICE																																											
1-24	\$11.80																																											
25-49	\$10.97																																											
50-99	\$10.15																																											
100 +	\$9.44																																											
PRICE																																												
1-24	\$10.99																																											
25-49	\$10.22																																											
50-99	\$9.45																																											
100 +	\$8.79																																											
PRICE																																												
1-24	\$44.23																																											
25-49	\$41.13																																											
50-99	\$38.04																																											
100 +	\$35.38																																											

Adapters

See Our Website For Real-Time Stock Availability!









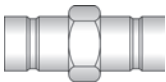

ADAPTERS

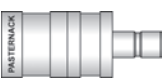
See Adapter Locator on Pages 140-145 or the Adapter Matrix on Pages 138-139

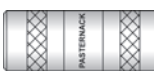
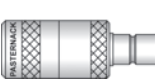
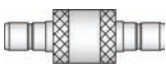
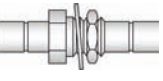
See Page 246 for Mounting Holes

Adapters



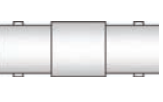
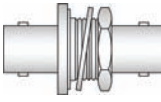
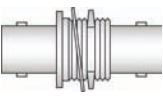
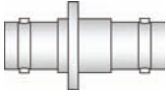
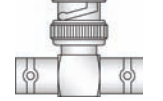
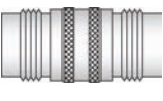







See Our Website For Real-Time Stock Availability!

	A	B	C	D																																								
1	 <table border="1"> <thead> <tr> <th colspan="2">PRICE</th> </tr> </thead> <tbody> <tr> <td>1-24</td> <td>\$44.23</td> </tr> <tr> <td>25-49</td> <td>\$41.13</td> </tr> <tr> <td>50-99</td> <td>\$38.04</td> </tr> <tr> <td>100 +</td> <td>\$35.38</td> </tr> </tbody> </table> <p>Model No: PE9248 75 Ohm SMB Jack To 75 Ohm SMB Jack</p>	PRICE		1-24	\$44.23	25-49	\$41.13	50-99	\$38.04	100 +	\$35.38	 <table border="1"> <thead> <tr> <th colspan="2">PRICE</th> </tr> </thead> <tbody> <tr> <td>1-24</td> <td>\$42.96</td> </tr> <tr> <td>25-49</td> <td>\$39.95</td> </tr> <tr> <td>50-99</td> <td>\$36.95</td> </tr> <tr> <td>100 +</td> <td>\$34.37</td> </tr> </tbody> </table> <p>Model No: PE9245 75 Ohm SMB "T" Jack-Plug-Jack</p>	PRICE		1-24	\$42.96	25-49	\$39.95	50-99	\$36.95	100 +	\$34.37	<p>75 Ohm SMB Between-Series</p> <p>→</p>		 <table border="1"> <thead> <tr> <th colspan="2">PRICE</th> </tr> </thead> <tbody> <tr> <td>1-24</td> <td>\$47.12</td> </tr> <tr> <td>25-49</td> <td>\$43.82</td> </tr> <tr> <td>50-99</td> <td>\$40.52</td> </tr> <tr> <td>100 +</td> <td>\$37.70</td> </tr> </tbody> </table> <p>Model No: PE9736 75 Ohm SMB Plug To Mini 75 Ohm SMB Jack</p>	PRICE		1-24	\$47.12	25-49	\$43.82	50-99	\$40.52	100 +	\$37.70									
PRICE																																												
1-24	\$44.23																																											
25-49	\$41.13																																											
50-99	\$38.04																																											
100 +	\$35.38																																											
PRICE																																												
1-24	\$42.96																																											
25-49	\$39.95																																											
50-99	\$36.95																																											
100 +	\$34.37																																											
PRICE																																												
1-24	\$47.12																																											
25-49	\$43.82																																											
50-99	\$40.52																																											
100 +	\$37.70																																											
2	 <table border="1"> <thead> <tr> <th colspan="2">PRICE</th> </tr> </thead> <tbody> <tr> <td>1-24</td> <td>\$47.12</td> </tr> <tr> <td>25-49</td> <td>\$43.82</td> </tr> <tr> <td>50-99</td> <td>\$40.52</td> </tr> <tr> <td>100 +</td> <td>\$37.70</td> </tr> </tbody> </table> <p>Model No: PE9735 75 Ohm SMB Jack To Mini 75 Ohm SMB Plug</p>	PRICE		1-24	\$47.12	25-49	\$43.82	50-99	\$40.52	100 +	\$37.70	<p>75 Ohm Mini SMB In-Series</p> <p>→</p>		 <table border="1"> <thead> <tr> <th colspan="2">PRICE</th> </tr> </thead> <tbody> <tr> <td>1-24</td> <td>\$22.87</td> </tr> <tr> <td>25-49</td> <td>\$21.27</td> </tr> <tr> <td>50-99</td> <td>\$19.67</td> </tr> <tr> <td>100 +</td> <td>\$18.30</td> </tr> </tbody> </table> <p>Model No: PE9609 Mini 75 Ohm SMB Plug To Mini 75 Ohm SMB Plug</p>	PRICE		1-24	\$22.87	25-49	\$21.27	50-99	\$19.67	100 +	\$18.30	 <table border="1"> <thead> <tr> <th colspan="2">PRICE</th> </tr> </thead> <tbody> <tr> <td>1-24</td> <td>\$35.26</td> </tr> <tr> <td>25-49</td> <td>\$32.79</td> </tr> <tr> <td>50-99</td> <td>\$30.32</td> </tr> <tr> <td>100 +</td> <td>\$28.21</td> </tr> </tbody> </table> <p>Model No: PE9610 Mini 75 Ohm SMB Plug To Mini 75 Ohm SMB Jack</p>	PRICE		1-24	\$35.26	25-49	\$32.79	50-99	\$30.32	100 +	\$28.21									
PRICE																																												
1-24	\$47.12																																											
25-49	\$43.82																																											
50-99	\$40.52																																											
100 +	\$37.70																																											
PRICE																																												
1-24	\$22.87																																											
25-49	\$21.27																																											
50-99	\$19.67																																											
100 +	\$18.30																																											
PRICE																																												
1-24	\$35.26																																											
25-49	\$32.79																																											
50-99	\$30.32																																											
100 +	\$28.21																																											
3	 <table border="1"> <thead> <tr> <th colspan="2">PRICE</th> </tr> </thead> <tbody> <tr> <td>1-24</td> <td>\$22.87</td> </tr> <tr> <td>25-49</td> <td>\$21.27</td> </tr> <tr> <td>50-99</td> <td>\$19.67</td> </tr> <tr> <td>100 +</td> <td>\$18.30</td> </tr> </tbody> </table> <p>Model No: PE9608 Mini 75 Ohm SMB Jack To Mini 75 Ohm SMB Jack</p>	PRICE		1-24	\$22.87	25-49	\$21.27	50-99	\$19.67	100 +	\$18.30	 <table border="1"> <thead> <tr> <th colspan="2">PRICE</th> </tr> </thead> <tbody> <tr> <td>1-24</td> <td>\$35.26</td> </tr> <tr> <td>25-49</td> <td>\$32.79</td> </tr> <tr> <td>50-99</td> <td>\$30.32</td> </tr> <tr> <td>100 +</td> <td>\$28.21</td> </tr> </tbody> </table> <p>Model No: PE9611 Mini 75 Ohm SMB Jack To Mini 75 Ohm SMB Jack Bulkhead Mounting Hole B01</p>	PRICE		1-24	\$35.26	25-49	\$32.79	50-99	\$30.32	100 +	\$28.21	 <table border="1"> <thead> <tr> <th colspan="2">PRICE</th> </tr> </thead> <tbody> <tr> <td>1-24</td> <td>\$58.87</td> </tr> <tr> <td>25-49</td> <td>\$54.75</td> </tr> <tr> <td>50-99</td> <td>\$50.63</td> </tr> <tr> <td>100 +</td> <td>\$47.10</td> </tr> </tbody> </table> <p>Model No: PE9616 Mini 75 Ohm SMB Plug To 75 Ohm BNC Male</p>	PRICE		1-24	\$58.87	25-49	\$54.75	50-99	\$50.63	100 +	\$47.10	 <table border="1"> <thead> <tr> <th colspan="2">PRICE</th> </tr> </thead> <tbody> <tr> <td>1-24</td> <td>\$45.90</td> </tr> <tr> <td>25-49</td> <td>\$42.69</td> </tr> <tr> <td>50-99</td> <td>\$39.47</td> </tr> <tr> <td>100 +</td> <td>\$36.72</td> </tr> </tbody> </table> <p>Model No: PE9617 Mini 75 Ohm SMB Plug To 75 Ohm BNC Female</p>	PRICE		1-24	\$45.90	25-49	\$42.69	50-99	\$39.47	100 +	\$36.72
PRICE																																												
1-24	\$22.87																																											
25-49	\$21.27																																											
50-99	\$19.67																																											
100 +	\$18.30																																											
PRICE																																												
1-24	\$35.26																																											
25-49	\$32.79																																											
50-99	\$30.32																																											
100 +	\$28.21																																											
PRICE																																												
1-24	\$58.87																																											
25-49	\$54.75																																											
50-99	\$50.63																																											
100 +	\$47.10																																											
PRICE																																												
1-24	\$45.90																																											
25-49	\$42.69																																											
50-99	\$39.47																																											
100 +	\$36.72																																											
4	 <table border="1"> <thead> <tr> <th colspan="2">PRICE</th> </tr> </thead> <tbody> <tr> <td>1-24</td> <td>\$58.87</td> </tr> <tr> <td>25-49</td> <td>\$54.75</td> </tr> <tr> <td>50-99</td> <td>\$50.63</td> </tr> <tr> <td>100 +</td> <td>\$47.10</td> </tr> </tbody> </table> <p>Model No: PE9618 Mini 75 Ohm SMB Jack To 75 Ohm BNC Male</p>	PRICE		1-24	\$58.87	25-49	\$54.75	50-99	\$50.63	100 +	\$47.10	 <table border="1"> <thead> <tr> <th colspan="2">PRICE</th> </tr> </thead> <tbody> <tr> <td>1-24</td> <td>\$58.87</td> </tr> <tr> <td>25-49</td> <td>\$54.75</td> </tr> <tr> <td>50-99</td> <td>\$50.63</td> </tr> <tr> <td>100 +</td> <td>\$47.10</td> </tr> </tbody> </table> <p>Model No: PE9619 Mini 75 Ohm SMB Jack To 75 Ohm BNC Female</p>	PRICE		1-24	\$58.87	25-49	\$54.75	50-99	\$50.63	100 +	\$47.10	<p>75 Ohm BNC In-Series</p> <p>→</p>		 <table border="1"> <thead> <tr> <th colspan="2">PRICE</th> </tr> </thead> <tbody> <tr> <td>1-24</td> <td>\$16.21</td> </tr> <tr> <td>25-49</td> <td>\$15.08</td> </tr> <tr> <td>50-99</td> <td>\$13.94</td> </tr> <tr> <td>100 +</td> <td>\$12.97</td> </tr> </tbody> </table> <p>Model No: PE9364 75 Ohm BNC Male To 75 Ohm BNC Male Mates With 50 Ohm BNC</p>	PRICE		1-24	\$16.21	25-49	\$15.08	50-99	\$13.94	100 +	\$12.97									
PRICE																																												
1-24	\$58.87																																											
25-49	\$54.75																																											
50-99	\$50.63																																											
100 +	\$47.10																																											
PRICE																																												
1-24	\$58.87																																											
25-49	\$54.75																																											
50-99	\$50.63																																											
100 +	\$47.10																																											
PRICE																																												
1-24	\$16.21																																											
25-49	\$15.08																																											
50-99	\$13.94																																											
100 +	\$12.97																																											
5	 <table border="1"> <thead> <tr> <th colspan="2">PRICE</th> </tr> </thead> <tbody> <tr> <td>1-24</td> <td>\$23.15</td> </tr> <tr> <td>25-49</td> <td>\$21.53</td> </tr> <tr> <td>50-99</td> <td>\$19.91</td> </tr> <tr> <td>100 +</td> <td>\$18.52</td> </tr> </tbody> </table> <p>Model No: PE9361 75 Ohm BNC Male To 75 Ohm BNC Female Right Angle Mates With 50 Ohm BNC</p>	PRICE		1-24	\$23.15	25-49	\$21.53	50-99	\$19.91	100 +	\$18.52	 <table border="1"> <thead> <tr> <th colspan="2">PRICE</th> </tr> </thead> <tbody> <tr> <td>1-24</td> <td>\$15.66</td> </tr> <tr> <td>25-49</td> <td>\$14.56</td> </tr> <tr> <td>50-99</td> <td>\$13.47</td> </tr> <tr> <td>100 +</td> <td>\$12.53</td> </tr> </tbody> </table> <p>Model No: PE9362 75 Ohm BNC Female To 75 Ohm BNC Female Mates With 50 Ohm BNC</p>	PRICE		1-24	\$15.66	25-49	\$14.56	50-99	\$13.47	100 +	\$12.53	 <table border="1"> <thead> <tr> <th colspan="2">PRICE</th> </tr> </thead> <tbody> <tr> <td>1-24</td> <td>\$25.99</td> </tr> <tr> <td>25-49</td> <td>\$24.17</td> </tr> <tr> <td>50-99</td> <td>\$22.35</td> </tr> <tr> <td>100 +</td> <td>\$20.79</td> </tr> </tbody> </table> <p>Model No: PE9363 75 Ohm BNC Female To 75 Ohm BNC Female Bulkhead Mates With 50 Ohm BNC Mounting Hole B06</p>	PRICE		1-24	\$25.99	25-49	\$24.17	50-99	\$22.35	100 +	\$20.79	 <table border="1"> <thead> <tr> <th colspan="2">PRICE</th> </tr> </thead> <tbody> <tr> <td>1-24</td> <td>\$27.54</td> </tr> <tr> <td>25-49</td> <td>\$25.61</td> </tr> <tr> <td>50-99</td> <td>\$23.68</td> </tr> <tr> <td>100 +</td> <td>\$22.03</td> </tr> </tbody> </table> <p>Model No: PE9366 75 Ohm BNC Female To 75 Ohm BNC Female Bulkhead, Isolated Ground Mates With 50 Ohm BNC Mounting Hole B06</p>	PRICE		1-24	\$27.54	25-49	\$25.61	50-99	\$23.68	100 +	\$22.03
PRICE																																												
1-24	\$23.15																																											
25-49	\$21.53																																											
50-99	\$19.91																																											
100 +	\$18.52																																											
PRICE																																												
1-24	\$15.66																																											
25-49	\$14.56																																											
50-99	\$13.47																																											
100 +	\$12.53																																											
PRICE																																												
1-24	\$25.99																																											
25-49	\$24.17																																											
50-99	\$22.35																																											
100 +	\$20.79																																											
PRICE																																												
1-24	\$27.54																																											
25-49	\$25.61																																											
50-99	\$23.68																																											
100 +	\$22.03																																											
6	 <table border="1"> <thead> <tr> <th colspan="2">PRICE</th> </tr> </thead> <tbody> <tr> <td>1-24</td> <td>\$26.60</td> </tr> <tr> <td>25-49</td> <td>\$24.74</td> </tr> <tr> <td>50-99</td> <td>\$22.88</td> </tr> <tr> <td>100 +</td> <td>\$21.28</td> </tr> </tbody> </table> <p>Model No: PE9367 75 Ohm BNC Female To 75 Ohm BNC Female, Panel Mount, Mates With 50 Ohm BNC Mounting Hole A03</p>	PRICE		1-24	\$26.60	25-49	\$24.74	50-99	\$22.88	100 +	\$21.28	 <table border="1"> <thead> <tr> <th colspan="2">PRICE</th> </tr> </thead> <tbody> <tr> <td>1-24</td> <td>\$26.28</td> </tr> <tr> <td>25-49</td> <td>\$24.44</td> </tr> <tr> <td>50-99</td> <td>\$22.60</td> </tr> <tr> <td>100 +</td> <td>\$21.02</td> </tr> </tbody> </table> <p>Model No: PE9365 75 Ohm BNC "T" Female-Male-Female Mates With 50 Ohm BNC</p>	PRICE		1-24	\$26.28	25-49	\$24.44	50-99	\$22.60	100 +	\$21.02	<p>3/4"-20 Twinax In-Series</p> <p>→</p>		 <table border="1"> <thead> <tr> <th colspan="2">PRICE</th> </tr> </thead> <tbody> <tr> <td>1-24</td> <td>\$17.12</td> </tr> <tr> <td>25-49</td> <td>\$15.92</td> </tr> <tr> <td>50-99</td> <td>\$14.72</td> </tr> <tr> <td>100 +</td> <td>\$13.70</td> </tr> </tbody> </table> <p>Model No: PE9199 3/4"-20 Twinax Female To 3/4"-20 Twinax Female</p>	PRICE		1-24	\$17.12	25-49	\$15.92	50-99	\$14.72	100 +	\$13.70									
PRICE																																												
1-24	\$26.60																																											
25-49	\$24.74																																											
50-99	\$22.88																																											
100 +	\$21.28																																											
PRICE																																												
1-24	\$26.28																																											
25-49	\$24.44																																											
50-99	\$22.60																																											
100 +	\$21.02																																											
PRICE																																												
1-24	\$17.12																																											
25-49	\$15.92																																											
50-99	\$14.72																																											
100 +	\$13.70																																											

ADAPTERS

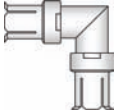
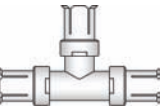
See Adapter Locator on Pages 140-145 or the Adapter Matrix on Pages 138-139

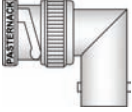
See Page 246 for Mounting Holes

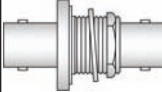
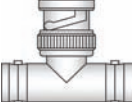
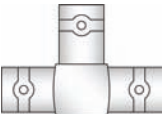
	A	B	C	D																																								
1	 <table border="1"> <thead> <tr> <th colspan="2">PRICE</th> </tr> </thead> <tbody> <tr> <td>1-24</td> <td>\$35.26</td> </tr> <tr> <td>25-49</td> <td>\$32.79</td> </tr> <tr> <td>50-99</td> <td>\$30.32</td> </tr> <tr> <td>100 +</td> <td>\$28.21</td> </tr> </tbody> </table> <p>Model No: PE9373 3/4"-20 Twinax Female To 3/4"-20 Twinax Female Bulkhead Mounting Hole B07</p>	PRICE		1-24	\$35.26	25-49	\$32.79	50-99	\$30.32	100 +	\$28.21	 <table border="1"> <thead> <tr> <th colspan="2">PRICE</th> </tr> </thead> <tbody> <tr> <td>1-24</td> <td>\$31.92</td> </tr> <tr> <td>25-49</td> <td>\$29.69</td> </tr> <tr> <td>50-99</td> <td>\$27.45</td> </tr> <tr> <td>100 +</td> <td>\$25.54</td> </tr> </tbody> </table> <p>Model No: PE9374 3/4"-20 Twinax "T" Female-Male- Female</p>	PRICE		1-24	\$31.92	25-49	\$29.69	50-99	\$27.45	100 +	\$25.54	 <table border="1"> <thead> <tr> <th colspan="2">PRICE</th> </tr> </thead> <tbody> <tr> <td>1-24</td> <td>\$35.26</td> </tr> <tr> <td>25-49</td> <td>\$32.79</td> </tr> <tr> <td>50-99</td> <td>\$30.32</td> </tr> <tr> <td>100 +</td> <td>\$28.21</td> </tr> </tbody> </table> <p>Model No: PE9224 3/4"-20 Twinax "T" Female- Female-Female</p>	PRICE		1-24	\$35.26	25-49	\$32.79	50-99	\$30.32	100 +	\$28.21	<p>D Subminiature In-Series</p> <p>→</p>										
PRICE																																												
1-24	\$35.26																																											
25-49	\$32.79																																											
50-99	\$30.32																																											
100 +	\$28.21																																											
PRICE																																												
1-24	\$31.92																																											
25-49	\$29.69																																											
50-99	\$27.45																																											
100 +	\$25.54																																											
PRICE																																												
1-24	\$35.26																																											
25-49	\$32.79																																											
50-99	\$30.32																																											
100 +	\$28.21																																											
2	 <table border="1"> <thead> <tr> <th colspan="2">PRICE</th> </tr> </thead> <tbody> <tr> <td>1-24</td> <td>\$41.14</td> </tr> <tr> <td>25-49</td> <td>\$38.26</td> </tr> <tr> <td>50-99</td> <td>\$35.38</td> </tr> <tr> <td>100 +</td> <td>\$32.91</td> </tr> </tbody> </table> <p>Model No: PE9688 D Subminiature Plug To D Subminiature Plug</p>	PRICE		1-24	\$41.14	25-49	\$38.26	50-99	\$35.38	100 +	\$32.91	 <table border="1"> <thead> <tr> <th colspan="2">PRICE</th> </tr> </thead> <tbody> <tr> <td>1-24</td> <td>\$41.14</td> </tr> <tr> <td>25-49</td> <td>\$38.26</td> </tr> <tr> <td>50-99</td> <td>\$35.38</td> </tr> <tr> <td>100 +</td> <td>\$32.91</td> </tr> </tbody> </table> <p>Model No: PE9687 D Subminiature Plug To D Subminiature Receptacle</p>	PRICE		1-24	\$41.14	25-49	\$38.26	50-99	\$35.38	100 +	\$32.91	 <table border="1"> <thead> <tr> <th colspan="2">PRICE</th> </tr> </thead> <tbody> <tr> <td>1-24</td> <td>\$41.14</td> </tr> <tr> <td>25-49</td> <td>\$38.26</td> </tr> <tr> <td>50-99</td> <td>\$35.38</td> </tr> <tr> <td>100 +</td> <td>\$32.91</td> </tr> </tbody> </table> <p>Model No: PE9689 D Subminiature Receptacle To D Subminiature Receptacle</p>	PRICE		1-24	\$41.14	25-49	\$38.26	50-99	\$35.38	100 +	\$32.91	<p>GR874 In-Series</p> <p>→</p>										
PRICE																																												
1-24	\$41.14																																											
25-49	\$38.26																																											
50-99	\$35.38																																											
100 +	\$32.91																																											
PRICE																																												
1-24	\$41.14																																											
25-49	\$38.26																																											
50-99	\$35.38																																											
100 +	\$32.91																																											
PRICE																																												
1-24	\$41.14																																											
25-49	\$38.26																																											
50-99	\$35.38																																											
100 +	\$32.91																																											
3	 <table border="1"> <thead> <tr> <th colspan="2">PRICE</th> </tr> </thead> <tbody> <tr> <td>1-24</td> <td>\$285.45</td> </tr> <tr> <td>25-49</td> <td>\$265.47</td> </tr> <tr> <td>50-99</td> <td>\$245.49</td> </tr> <tr> <td>100 +</td> <td>\$228.36</td> </tr> </tbody> </table> <p>Model No: PE9286 GR874 To GR874 Right Angle</p>	PRICE		1-24	\$285.45	25-49	\$265.47	50-99	\$245.49	100 +	\$228.36	 <table border="1"> <thead> <tr> <th colspan="2">PRICE</th> </tr> </thead> <tbody> <tr> <td>1-24</td> <td>\$285.45</td> </tr> <tr> <td>25-49</td> <td>\$265.47</td> </tr> <tr> <td>50-99</td> <td>\$245.49</td> </tr> <tr> <td>100 +</td> <td>\$228.36</td> </tr> </tbody> </table> <p>Model No: PE9285 GR874 "T"</p>	PRICE		1-24	\$285.45	25-49	\$265.47	50-99	\$245.49	100 +	\$228.36	<p>BNC Twinax In-Series</p> <p>→</p>	 <table border="1"> <thead> <tr> <th colspan="2">PRICE</th> </tr> </thead> <tbody> <tr> <td>1-24</td> <td>\$38.51</td> </tr> <tr> <td>25-49</td> <td>\$35.81</td> </tr> <tr> <td>50-99</td> <td>\$33.12</td> </tr> <tr> <td>100 +</td> <td>\$30.81</td> </tr> </tbody> </table> <p>Model No: PE9376 BNC Twinax Plug To BNC Twinax Plug</p>	PRICE		1-24	\$38.51	25-49	\$35.81	50-99	\$33.12	100 +	\$30.81										
PRICE																																												
1-24	\$285.45																																											
25-49	\$265.47																																											
50-99	\$245.49																																											
100 +	\$228.36																																											
PRICE																																												
1-24	\$285.45																																											
25-49	\$265.47																																											
50-99	\$245.49																																											
100 +	\$228.36																																											
PRICE																																												
1-24	\$38.51																																											
25-49	\$35.81																																											
50-99	\$33.12																																											
100 +	\$30.81																																											
4	 <table border="1"> <thead> <tr> <th colspan="2">PRICE</th> </tr> </thead> <tbody> <tr> <td>1-24</td> <td>\$47.73</td> </tr> <tr> <td>25-49</td> <td>\$44.39</td> </tr> <tr> <td>50-99</td> <td>\$41.05</td> </tr> <tr> <td>100 +</td> <td>\$38.18</td> </tr> </tbody> </table> <p>Model No: PE9377 BNC Twinax Plug To BNC Twinax Jack Right Angle</p>	PRICE		1-24	\$47.73	25-49	\$44.39	50-99	\$41.05	100 +	\$38.18	 <table border="1"> <thead> <tr> <th colspan="2">PRICE</th> </tr> </thead> <tbody> <tr> <td>1-24</td> <td>\$23.36</td> </tr> <tr> <td>25-49</td> <td>\$21.72</td> </tr> <tr> <td>50-99</td> <td>\$20.09</td> </tr> <tr> <td>100 +</td> <td>\$18.69</td> </tr> </tbody> </table> <p>Model No: PE9378 BNC Twinax Jack To BNC Twinax Jack</p>	PRICE		1-24	\$23.36	25-49	\$21.72	50-99	\$20.09	100 +	\$18.69	 <table border="1"> <thead> <tr> <th colspan="2">PRICE</th> </tr> </thead> <tbody> <tr> <td>1-24</td> <td>\$26.28</td> </tr> <tr> <td>25-49</td> <td>\$24.44</td> </tr> <tr> <td>50-99</td> <td>\$22.60</td> </tr> <tr> <td>100 +</td> <td>\$21.02</td> </tr> </tbody> </table> <p>Model No: PE9280 BNC Twinax Jack To BNC Twinax Jack Bulkhead Mounting Hole B06</p>	PRICE		1-24	\$26.28	25-49	\$24.44	50-99	\$22.60	100 +	\$21.02	 <table border="1"> <thead> <tr> <th colspan="2">PRICE</th> </tr> </thead> <tbody> <tr> <td>1-24</td> <td>\$34.35</td> </tr> <tr> <td>25-49</td> <td>\$31.95</td> </tr> <tr> <td>50-99</td> <td>\$29.54</td> </tr> <tr> <td>100 +</td> <td>\$27.48</td> </tr> </tbody> </table> <p>Model No: PE9375 BNC Twinax "T" Jack-Plug-Jack</p>	PRICE		1-24	\$34.35	25-49	\$31.95	50-99	\$29.54	100 +	\$27.48
PRICE																																												
1-24	\$47.73																																											
25-49	\$44.39																																											
50-99	\$41.05																																											
100 +	\$38.18																																											
PRICE																																												
1-24	\$23.36																																											
25-49	\$21.72																																											
50-99	\$20.09																																											
100 +	\$18.69																																											
PRICE																																												
1-24	\$26.28																																											
25-49	\$24.44																																											
50-99	\$22.60																																											
100 +	\$21.02																																											
PRICE																																												
1-24	\$34.35																																											
25-49	\$31.95																																											
50-99	\$29.54																																											
100 +	\$27.48																																											
5	 <table border="1"> <thead> <tr> <th colspan="2">PRICE</th> </tr> </thead> <tbody> <tr> <td>1-24</td> <td>\$40.43</td> </tr> <tr> <td>25-49</td> <td>\$37.60</td> </tr> <tr> <td>50-99</td> <td>\$34.77</td> </tr> <tr> <td>100 +</td> <td>\$32.34</td> </tr> </tbody> </table> <p>Model No: PE9279 BNC Twinax "T" Jack-Jack-Jack</p>	PRICE		1-24	\$40.43	25-49	\$37.60	50-99	\$34.77	100 +	\$32.34	<p>The world's first commercial cellular network was launched in Japan in 1979.</p>																																
PRICE																																												
1-24	\$40.43																																											
25-49	\$37.60																																											
50-99	\$34.77																																											
100 +	\$32.34																																											

Adapters

See Our Website For Real-Time Stock Availability!

Notes

INDEX GUIDE TO ATTENUATORS, TERMINATIONS, MATCHING PADS, COUPLERS, DIVIDERS AND MISC. RF COMPONENTS

ATTENUATORS.....185



Pasternack offers fixed and variable attenuator designs to 50 GHz. Fixed RF attenuators are available with various connector options and attenuation levels at power ratings from 1/2 watt to 500 watts. Variable attenuator designs include Continuously Variable Attenuators to 18 GHz. Step Attenuators in Dial, Programmable and Push Button designs in 50 and 75 Ohm designs are selectable with attenuation steps as small as 0.1 dB and attenuation levels to 110 dB.

Continuously Variable Attenuators.....	195	Step Attenuators, Dial.....	192
DC Bias Attenuators.....	194	Step Attenuators, Push Button.....	192
Fixed Attenuators.....	185	Step Attenuators, Toggle.....	193
Programmable Attenuators.....	194		

COUPLERS AND DIVIDERS.....199

COUPLERS..... 199

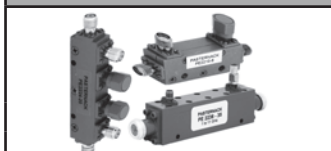

Pasternack offers directional and dual directional couplers in broadband, octave bands, and high power (600 Watt) versions. Coupling values vary from 6 to 35 db. Frequency options are available from 500 MHz to 18 GHz.

Dual Directional.....	201	Single Directional.....	199
Hybrids.....	202		

DIVIDERS.....202



Pasternack's line of connectorized Power Dividers are available with BNC, SMA, Type N, and 75 ohm BNC connectors. The number of ports vary from 2-way power split to 8-way power split. There is also a 12-way unit available with BNC connectors.

Reactive.....	202	Resistive.....	202
---------------	-----	----------------	-----

MISC. RF COMPONENTS.....204



Pasternack's Bias Tee's operate up to 50 GHz and current levels to 7 Amps. Our line of DC Blocks are available in 50 and 75 Ohm versions. Circulators and Isolators are offered in octave bands with SMA and N connector versions operating to 26.5 GHz. Connector Caps are available in shorting and non-shorting versions with or without a retaining chain. The broadband coax Surge Protectors use Type N connectors and feature field replaceable discharge cartridges. Bandpass, Lowpass and Highpass Filters have SMA connectors and are available in popular bands, such as WiFi and PCS. Connectorized Phase Trimmers and Shifters operate from DC - 40GHz and are available with SMA or 2.92mm connectors.

Bias Tees.....	206	Filters.....	207
Circulators and Isolators.....	208	Phase Shifters and Trimmers.....	209
Connectors Caps and Shorts.....	204	Surge Protectors.....	210
DC Blocks.....	205		

TERMINATIONS AND MATCHING PADS.....195

MATCHING PADS..... 198



Matching pads designed to mate with 50 ohm connectors on one end and 75 ohm connectors on the opposite end are available in a range of connector options.

Resistive Impedance Transformers.....	198
---------------------------------------	-----

TERMINATIONS..... 195



RF Coaxial Terminations are available in a number of connector options and frequency ranges. Power ratings for these terminations range from 1/2 watt to 500 watts of continuous power. 50 ohm and 75 ohm options are available as well.

Feed-Thru Load.....	198	RF Load.....	195
---------------------	-----	--------------	-----

ATTENUATORS

Fixed Attenuators

50 OHM

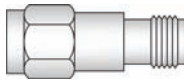

2.92mm

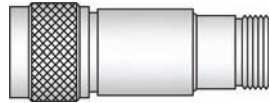

N

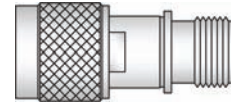

TNC

Max. Power	Connector	Max. Freq. (MHz.)	Construction Material	VSWR Max.	Attenuation (dB)	Model No					ROW
							1-24	25-49	50-99	100+	
0.5 WATT	2.92mm	40,000	Stainless Steel	1.40:1	3	PE7046-3	\$337.18	\$313.58	\$289.97	\$269.74	1
					6	PE7046-6	\$337.18	\$313.58	\$289.97	\$269.74	
					10	PE7046-10	\$337.18	\$313.58	\$289.97	\$269.74	
					20	PE7046-20	\$337.18	\$313.58	\$289.97	\$269.74	
					30	PE7046-30	\$337.18	\$313.58	\$289.97	\$269.74	
1 WATT	SMA	2,000	Stainless Steel	1.20:1	1	PE7161-1	\$42.96	\$39.95	\$36.95	\$34.37	2
					2	PE7161-2	\$42.96	\$39.95	\$36.95	\$34.37	
					3	PE7161-3	\$42.96	\$39.95	\$36.95	\$34.37	
					4	PE7161-4	\$42.96	\$39.95	\$36.95	\$34.37	
					5	PE7161-5	\$42.96	\$39.95	\$36.95	\$34.37	
					6	PE7161-6	\$42.96	\$39.95	\$36.95	\$34.37	
					7	PE7161-7	\$42.96	\$39.95	\$36.95	\$34.37	
					8	PE7161-8	\$42.96	\$39.95	\$36.95	\$34.37	
					9	PE7161-9	\$42.96	\$39.95	\$36.95	\$34.37	
					10	PE7161-10	\$42.96	\$39.95	\$36.95	\$34.37	
					12	PE7161-12	\$42.96	\$39.95	\$36.95	\$34.37	
					15	PE7161-15	\$42.96	\$39.95	\$36.95	\$34.37	
					20	PE7161-20	\$42.96	\$39.95	\$36.95	\$34.37	
					30	PE7161-30	\$42.96	\$39.95	\$36.95	\$34.37	
					40	PE7161-40	\$42.96	\$39.95	\$36.95	\$34.37	
	2.92mm	40,000	Stainless Steel	1.40:1	0	PE7088-0	\$189.50	\$176.24	\$162.97	\$151.60	3
					1	PE7088-1	\$189.50	\$176.24	\$162.97	\$151.60	
					2	PE7088-2	\$189.50	\$176.24	\$162.97	\$151.60	
					3	PE7088-3	\$189.50	\$176.24	\$162.97	\$151.60	
					4	PE7088-4	\$189.50	\$176.24	\$162.97	\$151.60	
					5	PE7088-5	\$189.50	\$176.24	\$162.97	\$151.60	
					6	PE7088-6	\$189.50	\$176.24	\$162.97	\$151.60	
					7	PE7088-7	\$189.50	\$176.24	\$162.97	\$151.60	
					8	PE7088-8	\$189.50	\$176.24	\$162.97	\$151.60	
					9	PE7088-9	\$189.50	\$176.24	\$162.97	\$151.60	
					10	PE7088-10	\$189.50	\$176.24	\$162.97	\$151.60	
					12	PE7088-12	\$189.50	\$176.24	\$162.97	\$151.60	
					15	PE7088-15	\$189.50	\$176.24	\$162.97	\$151.60	
					20	PE7088-20	\$189.50	\$176.24	\$162.97	\$151.60	
					30	PE7088-30	\$189.50	\$176.24	\$162.97	\$151.60	
	2.4mm	50,000	Stainless Steel	1.75:1	3	PE7089-3	\$295.00	\$274.35	\$253.70	\$236.00	4
					6	PE7089-6	\$295.00	\$274.35	\$253.70	\$236.00	
					10	PE7089-10	\$295.00	\$274.35	\$253.70	\$236.00	
					20	PE7089-20	\$295.00	\$274.35	\$253.70	\$236.00	
					30	PE7089-30	\$295.00	\$274.35	\$253.70	\$236.00	
	N	2,000	Nickel Plated Brass	1.25:1	1	PE7002-1	\$56.14	\$52.21	\$48.28	\$44.91	5
					2	PE7002-2	\$56.14	\$52.21	\$48.28	\$44.91	
					3	PE7002-3	\$56.14	\$52.21	\$48.28	\$44.91	
					6	PE7002-6	\$56.14	\$52.21	\$48.28	\$44.91	
					10	PE7002-10	\$56.14	\$52.21	\$48.28	\$44.91	
20					PE7002-20	\$56.14	\$52.21	\$48.28	\$44.91		
30					PE7002-30	\$56.14	\$52.21	\$48.28	\$44.91		
40					PE7002-40	\$72.96	\$67.85	\$62.75	\$58.37		
TNC	2,000	Nickel Plated Brass	1.40:1	1	PE7003-1	\$50.92	\$47.36	\$43.79	\$40.74	6	
				2	PE7003-2	\$50.92	\$47.36	\$43.79	\$40.74		
				3	PE7003-3	\$50.92	\$47.36	\$43.79	\$40.74		
				6	PE7003-6	\$50.92	\$47.36	\$43.79	\$40.74		
				10	PE7003-10	\$50.92	\$47.36	\$43.79	\$40.74		
				20	PE7003-20	\$50.92	\$47.36	\$43.79	\$40.74		
				30	PE7003-30	\$50.92	\$47.36	\$43.79	\$40.74		

Attenuators

See Our Website For Real-Time Stock Availability!

Fixed Attenuators

50 OHM

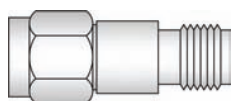

2.92mm

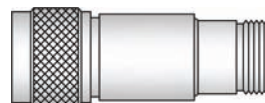

N

Max. Power	Connector	Max. Freq. (MHz.)	Construction Material	VSWR Max.	Attenuation (dB)	Model No	1-24	25-49	50-99	100+	ROW		
1 WATT	TNC	2,000	Nickel Plated Brass	1.40:1	40	PE7003-40	\$72.96	\$67.85	\$62.75	\$58.37	6		
	BNC			1.20:1	1	PE7000-1	\$33.69	\$31.33	\$28.97	\$26.95	7		
				2	PE7000-2	\$33.69	\$31.33	\$28.97	\$26.95				
				3	PE7000-3	\$33.69	\$31.33	\$28.97	\$26.95				
				6	PE7000-6	\$33.69	\$31.33	\$28.97	\$26.95				
				10	PE7000-10	\$33.69	\$31.33	\$28.97	\$26.95				
				20	PE7000-20	\$33.69	\$31.33	\$28.97	\$26.95				
2 WATT	SMA	3,000	Stainless Steel	1.15:1	30	PE7000-30	\$44.94	\$41.79	\$38.65	\$35.95	8		
					1	PE7001-1	\$56.14	\$52.21	\$48.28	\$44.91			
					2	PE7001-2	\$56.14	\$52.21	\$48.28	\$44.91			
					3	PE7001-3	\$56.14	\$52.21	\$48.28	\$44.91			
					4	PE7001-4	\$56.14	\$52.21	\$48.28	\$44.91			
					5	PE7001-5	\$56.14	\$52.21	\$48.28	\$44.91			
					6	PE7001-6	\$56.14	\$52.21	\$48.28	\$44.91			
					7	PE7001-7	\$56.14	\$52.21	\$48.28	\$44.91			
					8	PE7001-8	\$56.14	\$52.21	\$48.28	\$44.91			
					9	PE7001-9	\$56.14	\$52.21	\$48.28	\$44.91			
					10	PE7001-10	\$56.14	\$52.21	\$48.28	\$44.91			
					12	PE7001-12	\$56.14	\$52.21	\$48.28	\$44.91			
					15	PE7001-15	\$56.14	\$52.21	\$48.28	\$44.91			
					20	PE7001-20	\$56.14	\$52.21	\$48.28	\$44.91			
		30	PE7001-30	\$56.14	\$52.21	\$48.28	\$44.91						
		40	PE7001-40	\$72.96	\$67.85	\$62.75	\$58.37						
		6,000	Brass White Bronze Plated	1.20:1	1	PE7162-1	\$64.45	\$59.94	\$55.43	\$51.56	9		
					2	PE7162-2	\$64.45	\$59.94	\$55.43	\$51.56			
					3	PE7162-3	\$64.45	\$59.94	\$55.43	\$51.56			
					4	PE7162-4	\$64.45	\$59.94	\$55.43	\$51.56			
					5	PE7162-5	\$64.45	\$59.94	\$55.43	\$51.56			
					6	PE7162-6	\$64.45	\$59.94	\$55.43	\$51.56			
					7	PE7162-7	\$64.45	\$59.94	\$55.43	\$51.56			
					8	PE7162-8	\$64.45	\$59.94	\$55.43	\$51.56			
					9	PE7162-9	\$64.45	\$59.94	\$55.43	\$51.56			
					10	PE7162-10	\$64.45	\$59.94	\$55.43	\$51.56			
					12	PE7162-12	\$64.45	\$59.94	\$55.43	\$51.56			
					15	PE7162-15	\$64.45	\$59.94	\$55.43	\$51.56			
					20	PE7162-20	\$64.45	\$59.94	\$55.43	\$51.56			
					30	PE7162-30	\$64.45	\$59.94	\$55.43	\$51.56			
40	PE7162-40				\$64.45	\$59.94	\$55.43	\$51.56					
12,400	Stainless Steel				1.25:1	1	PE7045-1	\$78.63	\$73.13	\$67.62		\$62.90	10
						2	PE7045-2	\$78.63	\$73.13	\$67.62		\$62.90	
						3	PE7045-3	\$78.63	\$73.13	\$67.62		\$62.90	
						4	PE7045-4	\$78.63	\$73.13	\$67.62		\$62.90	
						5	PE7045-5	\$78.63	\$73.13	\$67.62		\$62.90	
		6	PE7045-6	\$78.63		\$73.13	\$67.62	\$62.90					
		7	PE7045-7	\$78.63		\$73.13	\$67.62	\$62.90					
		8	PE7045-8	\$78.63		\$73.13	\$67.62	\$62.90					
		9	PE7045-9	\$78.63		\$73.13	\$67.62	\$62.90					
		10	PE7045-10	\$78.63		\$73.13	\$67.62	\$62.90					
		12	PE7045-12	\$78.63		\$73.13	\$67.62	\$62.90					
		15	PE7045-15	\$78.63		\$73.13	\$67.62	\$62.90					
		20	PE7045-20	\$78.63		\$73.13	\$67.62	\$62.90					
		30	PE7045-30	\$78.63		\$73.13	\$67.62	\$62.90					
40	PE7045-40	\$101.13	\$94.05	\$86.97	\$80.90								
18,000	Stainless Steel	1.35:1	1	PE7005-1	\$91.60	\$85.19	\$78.78	\$73.28	11				
			2	PE7005-2	\$91.60	\$85.19	\$78.78	\$73.28					
			3	PE7005-3	\$91.60	\$85.19	\$78.78	\$73.28					
			4	PE7005-4	\$91.60	\$85.19	\$78.78	\$73.28					
			5	PE7005-5	\$91.60	\$85.19	\$78.78	\$73.28					
			6	PE7005-6	\$91.60	\$85.19	\$78.78	\$73.28					
			7	PE7005-7	\$91.60	\$85.19	\$78.78	\$73.28					

Attenuators

See Our Website For Real-Time Stock Availability!

Fixed Attenuators

50 OHM

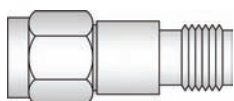

2.92mm

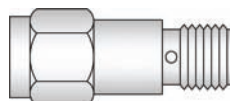

SMA

Max. Power	Connector	Max. Freq. (MHz.)	Construction Material	VSWR Max.	Attenuation (dB)	Model No	1-24	25-49	50-99	100+	ROW	
2 WATT	SMA	18,000	Stainless Steel	1.35:1	8	PE7005-8	\$91.60	\$85.19	\$78.78	\$73.28	11	
					9	PE7005-9	\$91.60	\$85.19	\$78.78	\$73.28		
					10	PE7005-10	\$91.60	\$85.19	\$78.78	\$73.28		
					12	PE7005-12	\$91.60	\$85.19	\$78.78	\$73.28		
					15	PE7005-15	\$91.60	\$85.19	\$78.78	\$73.28		
					20	PE7005-20	\$91.60	\$85.19	\$78.78	\$73.28		
		30			PE7005-30	\$91.60	\$85.19	\$78.78	\$73.28			
		40			PE7005-40	\$114.60	\$106.58	\$98.56	\$91.68	12		
		0			PE7087-0	\$69.50	\$64.64	\$59.77	\$55.60			
		1			PE7087-1	\$69.50	\$64.64	\$59.77	\$55.60			
		2			PE7087-2	\$69.50	\$64.64	\$59.77	\$55.60			
		3			PE7087-3	\$69.50	\$64.64	\$59.77	\$55.60			
		4			PE7087-4	\$69.50	\$64.64	\$59.77	\$55.60			
		5			PE7087-5	\$69.50	\$64.64	\$59.77	\$55.60			
		6			PE7087-6	\$69.50	\$64.64	\$59.77	\$55.60			
		7			PE7087-7	\$69.50	\$64.64	\$59.77	\$55.60			
		8			PE7087-8	\$69.50	\$64.64	\$59.77	\$55.60			
		9			PE7087-9	\$69.50	\$64.64	\$59.77	\$55.60			
	10	PE7087-10		\$69.50	\$64.64	\$59.77	\$55.60					
	12	PE7087-12		\$69.50	\$64.64	\$59.77	\$55.60					
	15	PE7087-15		\$69.50	\$64.64	\$59.77	\$55.60					
	20	PE7087-20		\$69.50	\$64.64	\$59.77	\$55.60					
	30	PE7087-30		\$69.50	\$64.64	\$59.77	\$55.60					
	26,500	2.92mm		26,500	1.40:1	1	PE7024-1	\$191.06	\$177.69	\$164.31	\$152.85	13
						2	PE7024-2	\$191.06	\$177.69	\$164.31	\$152.85	
						3	PE7024-3	\$191.06	\$177.69	\$164.31	\$152.85	
						6	PE7024-6	\$191.06	\$177.69	\$164.31	\$152.85	
						10	PE7024-10	\$191.06	\$177.69	\$164.31	\$152.85	
						20	PE7024-20	\$191.06	\$177.69	\$164.31	\$152.85	
						30	PE7024-30	\$191.06	\$177.69	\$164.31	\$152.85	14
						3	PE7090-3	\$255.00	\$237.15	\$219.30	\$204.00	
						6	PE7090-6	\$255.00	\$237.15	\$219.30	\$204.00	
						10	PE7090-10	\$255.00	\$237.15	\$219.30	\$204.00	
						15	PE7090-15	\$255.00	\$237.15	\$219.30	\$204.00	
						20	PE7090-20	\$255.00	\$237.15	\$219.30	\$204.00	
	30	PE7090-30		\$255.00	\$237.15	\$219.30	\$204.00	15				
	1	PE7047-1		\$111.31	\$103.52	\$95.73	\$89.05					
	2	PE7047-2		\$111.31	\$103.52	\$95.73	\$89.05					
	3	PE7047-3		\$111.31	\$103.52	\$95.73	\$89.05					
	4	PE7047-4		\$111.31	\$103.52	\$95.73	\$89.05					
	5	PE7047-5		\$111.31	\$103.52	\$95.73	\$89.05					
	6	PE7047-6		\$111.31	\$103.52	\$95.73	\$89.05					
	7	PE7047-7		\$111.31	\$103.52	\$95.73	\$89.05					
	8	PE7047-8		\$111.31	\$103.52	\$95.73	\$89.05					
	9	PE7047-9		\$111.31	\$103.52	\$95.73	\$89.05					
	10	PE7047-10		\$111.31	\$103.52	\$95.73	\$89.05					
	12	PE7047-12		\$111.31	\$103.52	\$95.73	\$89.05					
	15	PE7047-15		\$111.31	\$103.52	\$95.73	\$89.05					
20	PE7047-20	\$111.31	\$103.52	\$95.73	\$89.05							
30	PE7047-30	\$111.31	\$103.52	\$95.73	\$89.05							
40	PE7047-40	\$146.12	\$135.89	\$125.66	\$116.90	16						
18,000	N	18,000	1.35:1	1	PE7004-1		\$143.33	\$133.30	\$123.26	\$114.66		
				2	PE7004-2		\$143.33	\$133.30	\$123.26	\$114.66		
				3	PE7004-3		\$143.33	\$133.30	\$123.26	\$114.66		
				4	PE7004-4		\$143.33	\$133.30	\$123.26	\$114.66		
				5	PE7004-5		\$143.33	\$133.30	\$123.26	\$114.66		
				6	PE7004-6		\$143.33	\$133.30	\$123.26	\$114.66		
				7	PE7004-7		\$143.33	\$133.30	\$123.26	\$114.66		
				8	PE7004-8		\$143.33	\$133.30	\$123.26	\$114.66		
				9	PE7004-9	\$143.33	\$133.30	\$123.26	\$114.66			

Attenuators

See Our Website For Real-Time Stock Availability!

Fixed Attenuators

50 OHM

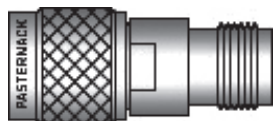

TNC

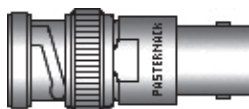

BNC

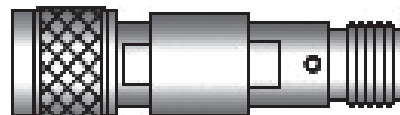

TNC

Max. Power	Connector	Max. Freq. (MHz.)	Construction Material	VSWR Max.	Attenuation (dB)	Model No	1-24	25-49	50-99	100+	ROW				
2 WATT	N	18,000	Stainless Steel	1.35:1	10	PE7004-10	\$143.33	\$133.30	\$123.26	\$114.66	16				
					12	PE7004-12	\$143.33	\$133.30	\$123.26	\$114.66					
					15	PE7004-15	\$143.33	\$133.30	\$123.26	\$114.66					
					20	PE7004-20	\$143.33	\$133.30	\$123.26	\$114.66					
					30	PE7004-30	\$143.33	\$133.30	\$123.26	\$114.66					
	TNC	12,400	Nickel Plated Brass	1.25:1	1	PE7051-1	\$101.13	\$94.05	\$86.97	\$80.90	17				
					2	PE7051-2	\$101.13	\$94.05	\$86.97	\$80.90					
					3	PE7051-3	\$101.13	\$94.05	\$86.97	\$80.90					
					6	PE7051-6	\$101.13	\$94.05	\$86.97	\$80.90					
					10	PE7051-10	\$101.13	\$94.05	\$86.97	\$80.90					
					20	PE7051-20	\$101.13	\$94.05	\$86.97	\$80.90					
					30	PE7051-30	\$101.13	\$94.05	\$86.97	\$80.90					
					40	PE7051-40	\$123.57	\$114.92	\$106.27	\$98.86					
					18,000	Stainless Steel	1.35:1	1	PE7030-1	\$202.25		\$188.09	\$173.94	\$161.80	18
								2	PE7030-2	\$202.25		\$188.09	\$173.94	\$161.80	
	3	PE7030-3	\$202.25	\$188.09				\$173.94	\$161.80						
	6	PE7030-6	\$202.25	\$188.09				\$173.94	\$161.80						
	10	PE7030-10	\$202.25	\$188.09				\$173.94	\$161.80						
	7mm	Stainless Steel	1.20:1	20	PE7030-20	\$202.25	\$188.09	\$173.94	\$161.80	19					
				30	PE7030-30	\$202.25	\$188.09	\$173.94	\$161.80						
1				PE7023-1	\$393.41	\$365.87	\$338.33	\$314.73							
2				PE7023-2	\$393.41	\$365.87	\$338.33	\$314.73							
3				PE7023-3	\$393.41	\$365.87	\$338.33	\$314.73							
6				PE7023-6	\$393.41	\$365.87	\$338.33	\$314.73							
10				PE7023-10	\$393.41	\$365.87	\$338.33	\$314.73							
BNC	4,000	Nickel Plated Brass	1.25:1	20	PE7023-20	\$393.41	\$365.87	\$338.33	\$314.73	20					
				30	PE7023-30	\$393.41	\$365.87	\$338.33	\$314.73						
				1	PE7049-1	\$78.63	\$73.13	\$67.62	\$62.90						
				2	PE7049-2	\$78.63	\$73.13	\$67.62	\$62.90						
				3	PE7049-3	\$78.63	\$73.13	\$67.62	\$62.90						
				6	PE7049-6	\$78.63	\$73.13	\$67.62	\$62.90						
				10	PE7049-10	\$78.63	\$73.13	\$67.62	\$62.90						
				20	PE7049-20	\$78.63	\$73.13	\$67.62	\$62.90						
				30	PE7049-30	\$78.63	\$73.13	\$67.62	\$62.90						
				5 WATT	7-16 DIN	6,000	Brass White Bronze Plated	1.25:1	1		PE7039-1	\$168.56	\$156.76	\$144.96	\$134.85
2	PE7039-2	\$168.56	\$156.76						\$144.96	\$134.85					
3	PE7039-3	\$168.56	\$156.76						\$144.96	\$134.85					
6	PE7039-6	\$168.56	\$156.76						\$144.96	\$134.85					
10	PE7039-10	\$168.56	\$156.76						\$144.96	\$134.85					
20	PE7039-20	\$168.56	\$156.76						\$144.96	\$134.85					
30	PE7039-30	\$168.56	\$156.76						\$144.96	\$134.85					
SMA	18,000	Aluminum Heatsink	1.35:1		40	PE7039-40	\$191.06	\$177.69	\$164.31	\$152.85	22				
					1	PE7013-1	\$123.57	\$114.92	\$106.27	\$98.86					
					2	PE7013-2	\$123.57	\$114.92	\$106.27	\$98.86					
					3	PE7013-3	\$123.57	\$114.92	\$106.27	\$98.86					
					6	PE7013-6	\$123.57	\$114.92	\$106.27	\$98.86					
					10	PE7013-10	\$123.57	\$114.92	\$106.27	\$98.86					
					20	PE7013-20	\$123.57	\$114.92	\$106.27	\$98.86					
					30	PE7013-30	\$123.57	\$114.92	\$106.27	\$98.86					
N	18,000	Aluminum Heatsink	1.40:1	40	PE7013-40	\$146.12	\$135.89	\$125.66	\$116.90	23					
				1	PE7014-1	\$202.25	\$188.09	\$173.94	\$161.80						
				2	PE7014-2	\$202.25	\$188.09	\$173.94	\$161.80						
				3	PE7014-3	\$202.25	\$188.09	\$173.94	\$161.80						
				6	PE7014-6	\$202.25	\$188.09	\$173.94	\$161.80						
				10	PE7014-10	\$202.25	\$188.09	\$173.94	\$161.80						
				20	PE7014-20	\$202.25	\$188.09	\$173.94	\$161.80						
TNC	18,000	Aluminum Heatsink	1.35:1	30	PE7014-30	\$202.25	\$188.09	\$173.94	\$161.80	24					
				40	PE7014-40	\$224.75	\$209.02	\$193.29	\$179.80						
				1	PE7052-1	\$224.75	\$209.02	\$193.29	\$179.80						
				2	PE7052-2	\$224.75	\$209.02	\$193.29	\$179.80						
				3	PE7052-3	\$224.75	\$209.02	\$193.29	\$179.80						
				6	PE7052-6	\$224.75	\$209.02	\$193.29	\$179.80						
				10	PE7052-10	\$224.75	\$209.02	\$193.29	\$179.80						
				20	PE7052-20	\$224.75	\$209.02	\$193.29	\$179.80						
30	PE7052-30	\$224.75	\$209.02	\$193.29	\$179.80										

Attenuators

See Our Website For Real-Time Stock Availability!

Fixed Attenuators

50 OHM

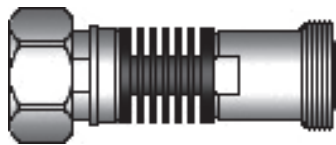

7-16 DIN



N

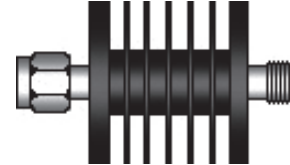

SMA

Max. Power	Connector	Max. Freq. (MHz.)	Construction Material	VSWR Max.	Attenuation (dB)	Model No	1-24	25-49	50-99	100+	ROW
10 WATT	7-16 DIN	7,500	Aluminum Heatsink	1.45:1	1	PE7040-1	\$247.25	\$229.94	\$212.64	\$197.80	25
					2	PE7040-2	\$247.25	\$229.94	\$212.64	\$197.80	
					3	PE7040-3	\$247.25	\$229.94	\$212.64	\$197.80	
					6	PE7040-6	\$247.25	\$229.94	\$212.64	\$197.80	
					10	PE7040-10	\$247.25	\$229.94	\$212.64	\$197.80	
					20	PE7040-20	\$247.25	\$229.94	\$212.64	\$197.80	
					30	PE7040-30	\$247.25	\$229.94	\$212.64	\$197.80	
					40	PE7040-40	\$269.74	\$250.86	\$231.98	\$215.79	
	SMA	18,000		1.40:1	1	PE7016-1	\$258.49	\$240.40	\$222.30	\$206.79	26
					2	PE7016-2	\$258.49	\$240.40	\$222.30	\$206.79	
					3	PE7016-3	\$258.49	\$240.40	\$222.30	\$206.79	
					6	PE7016-6	\$258.49	\$240.40	\$222.30	\$206.79	
					10	PE7016-10	\$258.49	\$240.40	\$222.30	\$206.79	
					20	PE7016-20	\$258.49	\$240.40	\$222.30	\$206.79	
					30	PE7016-30	\$258.49	\$240.40	\$222.30	\$206.79	
					40	PE7016-40	\$280.99	\$261.32	\$241.65	\$224.79	
	N	2,000		1.20:1	2	PE7010-2	\$168.56	\$156.76	\$144.96	\$134.85	27
					3	PE7010-3	\$168.56	\$156.76	\$144.96	\$134.85	
					6	PE7010-6	\$168.56	\$156.76	\$144.96	\$134.85	
					10	PE7010-10	\$204.38	\$190.07	\$175.77	\$163.50	
		12,400		1.35:1	1	PE7048-1	\$258.49	\$240.40	\$222.30	\$206.79	28
					2	PE7048-2	\$258.49	\$240.40	\$222.30	\$206.79	
					3	PE7048-3	\$258.49	\$240.40	\$222.30	\$206.79	
					6	PE7048-6	\$258.49	\$240.40	\$222.30	\$206.79	
	TNC	18,000		1.40:1	10	PE7048-10	\$258.49	\$240.40	\$222.30	\$206.79	29
					20	PE7048-20	\$258.49	\$240.40	\$222.30	\$206.79	
					30	PE7048-30	\$258.49	\$240.40	\$222.30	\$206.79	
					40	PE7048-40	\$280.99	\$261.32	\$241.65	\$224.79	
					1	PE7015-1	\$280.99	\$261.32	\$241.65	\$224.79	
					2	PE7015-2	\$280.99	\$261.32	\$241.65	\$224.79	
					3	PE7015-3	\$280.99	\$261.32	\$241.65	\$224.79	
					6	PE7015-6	\$280.99	\$261.32	\$241.65	\$224.79	
	BNC	2,000		1.60:1	10	PE7015-10	\$286.56	\$266.50	\$246.44	\$229.25	30
					20	PE7015-20	\$286.56	\$266.50	\$246.44	\$229.25	
					30	PE7015-30	\$286.56	\$266.50	\$246.44	\$229.25	
					40	PE7015-40	\$303.43	\$282.19	\$260.95	\$242.74	
					1	PE7053-1	\$337.18	\$313.58	\$289.97	\$269.74	
					2	PE7053-2	\$337.18	\$313.58	\$289.97	\$269.74	
					3	PE7053-3	\$337.18	\$313.58	\$289.97	\$269.74	
					6	PE7053-6	\$337.18	\$313.58	\$289.97	\$269.74	
7-16 DIN	7,500	1.60:1	10	PE7053-10	\$337.18	\$313.58	\$289.97	\$269.74	31		
			20	PE7053-20	\$337.18	\$313.58	\$289.97	\$269.74			
			30	PE7053-30	\$337.18	\$313.58	\$289.97	\$269.74			
			40	PE7053-40	\$370.87	\$344.91	\$318.95	\$296.70			
			2	PE7025-2	\$213.50	\$198.56	\$183.61	\$170.80			
			3	PE7025-3	\$213.50	\$198.56	\$183.61	\$170.80			
			6	PE7025-6	\$213.50	\$198.56	\$183.61	\$170.80			
			10	PE7025-10	\$213.50	\$198.56	\$183.61	\$170.80			
SMA	18,000	1.40:1	20	PE7025-20	\$213.50	\$198.56	\$183.61	\$170.80	32		
			30	PE7025-30	\$213.50	\$198.56	\$183.61	\$170.80			
			40	PE7025-40	\$247.25	\$229.94	\$212.64	\$197.80			
			1	PE7041-1	\$393.41	\$365.87	\$338.33	\$314.73			
			2	PE7041-2	\$393.41	\$365.87	\$338.33	\$314.73			
			3	PE7041-3	\$393.41	\$365.87	\$338.33	\$314.73			
			6	PE7041-6	\$393.41	\$365.87	\$338.33	\$314.73			
			10	PE7041-10	\$393.41	\$365.87	\$338.33	\$314.73			
25 WATT	7-16 DIN	7,500	Aluminum Heatsink	DC - 4,000: 1.25:1 4,000 - 7,500: 1.45:1	20	PE7041-20	\$393.41	\$365.87	\$338.33	\$314.73	33
					30	PE7041-30	\$393.41	\$365.87	\$338.33	\$314.73	
25 WATT	SMA	18,000	Aluminum Heatsink	1.40:1	40	PE7041-40	\$415.81	\$386.70	\$357.60	\$332.65	33
					1	PE7018-1	\$393.41	\$365.87	\$338.33	\$314.73	
25 WATT	SMA	18,000	Aluminum Heatsink	1.40:1	2	PE7018-2	\$393.41	\$365.87	\$338.33	\$314.73	33

Attenuators

See Our Website For Real-Time Stock Availability!



Fixed Attenuators

50 OHM

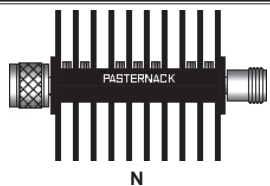

N

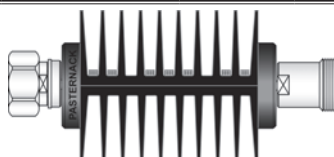

7-16 DIN

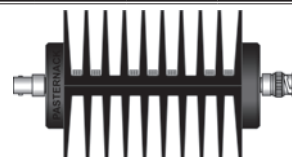

BNC

Attenuators

See Our Website For Real-Time Stock Availability!

Max. Power	Connector	Max. Freq. (MHz.)	Construction Material	VSWR Max.	Attenuation (dB)	Model No	1-24	25-49	50-99	100+	ROW	
25 WATT	SMA	18,000	Aluminum Heatsink	1.40:1	3	PE7018-3	\$393.41	\$365.87	\$338.33	\$314.73	33	
					6	PE7018-6	\$393.41	\$365.87	\$338.33	\$314.73		
					10	PE7018-10	\$393.41	\$365.87	\$338.33	\$314.73		
					20	PE7018-20	\$393.41	\$365.87	\$338.33	\$314.73		
					30	PE7018-30	\$393.41	\$365.87	\$338.33	\$314.73		
					40	PE7018-40	\$415.81	\$386.70	\$357.60	\$332.65		
	N				1	PE7017-1	\$393.41	\$365.87	\$338.33	\$314.73	34	
					2	PE7017-2	\$393.41	\$365.87	\$338.33	\$314.73		
					3	PE7017-3	\$393.41	\$365.87	\$338.33	\$314.73		
					6	PE7017-6	\$393.41	\$365.87	\$338.33	\$314.73		
					10	PE7017-10	\$393.41	\$365.87	\$338.33	\$314.73		
					20	PE7017-20	\$393.41	\$365.87	\$338.33	\$314.73		
					30	PE7017-30	\$393.41	\$365.87	\$338.33	\$314.73		
					40	PE7017-40	\$449.60	\$418.13	\$386.66	\$359.68		
	TNC				1	PE7054-1	\$483.34	\$449.51	\$415.67	\$386.67	35	
					2	PE7054-2	\$483.34	\$449.51	\$415.67	\$386.67		
3		PE7054-3	\$483.34	\$449.51	\$415.67	\$386.67						
6		PE7054-6	\$483.34	\$449.51	\$415.67	\$386.67						
10		PE7054-10	\$483.34	\$449.51	\$415.67	\$386.67						
20		PE7054-20	\$483.34	\$449.51	\$415.67	\$386.67						
30		PE7054-30	\$483.34	\$449.51	\$415.67	\$386.67						
40		PE7054-40	\$505.79	\$470.38	\$434.98	\$404.63						
50 WATT	7-16 DIN	18,000	Aluminum Heatsink	1.40:1	6	PE7042-6	\$449.60	\$418.13	\$386.66	\$359.68	36	
					10	PE7042-10	\$449.60	\$418.13	\$386.66	\$359.68		
					1.45:1	20	PE7042-20	\$449.60	\$418.13	\$386.66		\$359.68
					30	PE7042-30	\$449.60	\$418.13	\$386.66	\$359.68		
					1.40:1	40	PE7042-40	\$449.60	\$418.13	\$386.66		\$359.68
					6	PE7020-6	\$460.80	\$428.54	\$396.29	\$368.64		
	SMA			1.45:1	10	PE7020-10	\$460.80	\$428.54	\$396.29	\$368.64	37	
					20	PE7020-20	\$460.80	\$428.54	\$396.29	\$368.64		
					30	PE7020-30	\$460.80	\$428.54	\$396.29	\$368.64		
					40	PE7020-40	\$483.34	\$449.51	\$415.67	\$386.67		
					6	PE7019-6	\$449.60	\$418.13	\$386.66	\$359.68		
					10	PE7019-10	\$449.60	\$418.13	\$386.66	\$359.68		
N	1.45:1	20	PE7019-20	\$449.60	\$418.13	\$386.66	\$359.68	38				
		30	PE7019-30	\$458.57	\$426.47	\$394.37	\$366.86					
		40	PE7019-40	\$505.79	\$470.38	\$434.98	\$404.63					
		6	PE7055-6	\$561.98	\$522.64	\$483.30	\$449.58					
		10	PE7055-10	\$561.98	\$522.64	\$483.30	\$449.58					
		20	PE7055-20	\$561.98	\$522.64	\$483.30	\$449.58					
TNC	1.45:1	30	PE7055-30	\$561.98	\$522.64	\$483.30	\$449.58	39				
		40	PE7055-40	\$584.47	\$543.56	\$502.64	\$467.58					
		6	PE7043-6	\$505.79	\$470.38	\$434.98	\$404.63					
		10	PE7043-10	\$505.79	\$470.38	\$434.98	\$404.63					
		20	PE7043-20	\$505.79	\$470.38	\$434.98	\$404.63					
		30	PE7043-30	\$505.79	\$470.38	\$434.98	\$404.63					
100 WATT	7-16 DIN	1,500	Aluminum Heatsink	1.25:1	40	PE7043-40	\$505.79	\$470.38	\$434.98	\$404.63	40	
					6	PE7022-6	\$618.21	\$574.94	\$531.66	\$494.57		
					10	PE7022-10	\$618.21	\$574.94	\$531.66	\$494.57		
					20	PE7022-20	\$618.21	\$574.94	\$531.66	\$494.57		
					30	PE7022-30	\$618.21	\$574.94	\$531.66	\$494.57		
					40	PE7022-40	\$640.71	\$595.86	\$551.01	\$512.57		
	SMA			1.25:1	6	PE7021-6	\$561.98	\$522.64	\$483.30	\$449.58	41	
					10	PE7021-10	\$561.98	\$522.64	\$483.30	\$449.58		
					20	PE7021-20	\$561.98	\$522.64	\$483.30	\$449.58		
					30	PE7021-30	\$561.98	\$522.64	\$483.30	\$449.58		
					40	PE7021-40	\$618.21	\$574.94	\$531.66	\$494.57		
					6	PE7056-6	\$674.35	\$627.15	\$579.94	\$539.48		
	N			1.25:1	10	PE7056-10	\$674.35	\$627.15	\$579.94	\$539.48	42	
					20	PE7056-20	\$674.35	\$627.15	\$579.94	\$539.48		
					30	PE7056-30	\$674.35	\$627.15	\$579.94	\$539.48		
					40	PE7056-40	\$696.90	\$648.12	\$599.33	\$557.52		
					6	PE7026-6	\$618.21	\$574.94	\$531.66	\$494.57		
					10	PE7026-10	\$618.21	\$574.94	\$531.66	\$494.57		
TNC	1.40:1	20	PE7056-20	\$674.35	\$627.15	\$579.94	\$539.48	43				
		30	PE7056-30	\$674.35	\$627.15	\$579.94	\$539.48					
		40	PE7056-40	\$696.90	\$648.12	\$599.33	\$557.52					
		3	PE7026-3	\$618.21	\$574.94	\$531.66	\$494.57					
		6	PE7026-6	\$618.21	\$574.94	\$531.66	\$494.57					
		10	PE7026-10	\$618.21	\$574.94	\$531.66	\$494.57					
BNC	1,000				3	PE7026-3	\$618.21	\$574.94	\$531.66	\$494.57	44	

ROHS & REACH COMPLIANT. CUSTOM-LENGTH CABLE ASSEMBLIES MAY BE ORDERED ON OUR WEBSITE.

Fixed Attenuators

50 OHM

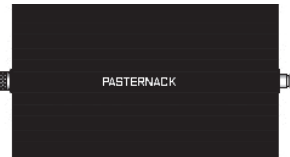

N

N

Max. Power	Connector	Max. Freq. (MHz.)	Construction Material	VSWR Max.	Attenuation (dB)	Model No	1-24	25-49	50-99	100+	ROW
100 WATT	BNC	1,000	Aluminum Heatsink	1.40:1	6	PE7026-6	\$618.21	\$574.94	\$531.66	\$494.57	44
					10	PE7026-10	\$618.21	\$574.94	\$531.66	\$494.57	
					20	PE7026-20	\$618.21	\$574.94	\$531.66	\$494.57	
					30	PE7026-30	\$618.21	\$574.94	\$531.66	\$494.57	
					40	PE7026-40	\$669.89	\$623.00	\$576.11	\$535.91	
300 WATT	N	1,000	Aluminum Heatsink	1.40:1	2	PE7031-2	\$1,455.66	\$1,353.76	\$1,251.87	\$1,164.53	45
					3	PE7031-3	\$1,455.66	\$1,353.76	\$1,251.87	\$1,164.53	
					6	PE7031-6	\$1,455.66	\$1,353.76	\$1,251.87	\$1,164.53	
					10	PE7031-10	\$1,455.66	\$1,353.76	\$1,251.87	\$1,164.53	
					20	PE7031-20	\$1,455.66	\$1,353.76	\$1,251.87	\$1,164.53	
					30	PE7031-30	\$1,455.66	\$1,353.76	\$1,251.87	\$1,164.53	
500 WATT	N	500	Aluminum Heatsink	1.15:1	2	PE7032-2	\$1,686.08	\$1,568.05	\$1,450.03	\$1,348.86	46
					3	PE7085-3	\$1,720.58	\$1,600.14	\$1,479.70	\$1,376.46	
					6	PE7032-6	\$1,686.08	\$1,568.05	\$1,450.03	\$1,348.86	
					10	PE7032-10	\$1,686.08	\$1,568.05	\$1,450.03	\$1,348.86	
					20	PE7032-20	\$1,686.08	\$1,568.05	\$1,450.03	\$1,348.86	
					30	PE7032-30	\$1,686.08	\$1,568.05	\$1,450.03	\$1,348.86	

75 OHM

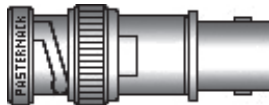

N

BNC

F

Max. Power	Connector	Max. Freq. (MHz.)	Construction Material	VSWR Max.	Attenuation (dB)	Model No	1-24	25-49	50-99	100+	ROW			
1 WATT	N	1,000	Nickel Plated Brass	1.30:1	1	PE7029-1	\$56.14	\$52.21	\$48.28	\$44.91	47			
					2	PE7029-2	\$56.14	\$52.21	\$48.28	\$44.91				
					3	PE7029-3	\$56.14	\$52.21	\$48.28	\$44.91				
					6	PE7029-6	\$56.14	\$52.21	\$48.28	\$44.91				
					10	PE7029-10	\$56.14	\$52.21	\$48.28	\$44.91				
	BNC				1	PE7009-1	\$39.27	\$36.52	\$33.77	\$31.42		48		
					2	PE7009-2	\$39.27	\$36.52	\$33.77	\$31.42				
					3	PE7009-3	\$39.27	\$36.52	\$33.77	\$31.42				
					6	PE7009-6	\$39.27	\$36.52	\$33.77	\$31.42				
					10	PE7009-10	\$39.27	\$36.52	\$33.77	\$31.42				
2 WATT	N	4,000	Nickel Plated Brass	1.30:1	1	PE7044-1	\$112.32	\$104.46	\$96.60	\$89.86	49			
					2	PE7044-2	\$112.32	\$104.46	\$96.60	\$89.86				
					3	PE7044-3	\$112.32	\$104.46	\$96.60	\$89.86				
					6	PE7044-6	\$112.32	\$104.46	\$96.60	\$89.86				
					10	PE7044-10	\$112.32	\$104.46	\$96.60	\$89.86				
					20	PE7044-20	\$112.32	\$104.46	\$96.60	\$89.86				
	F	1,000			1	PE7057-1	\$72.96	\$67.85	\$62.75	\$58.37	50			
					2	PE7057-2	\$72.96	\$67.85	\$62.75	\$58.37				
					3	PE7057-3	\$72.96	\$67.85	\$62.75	\$58.37				
					6	PE7057-6	\$72.96	\$67.85	\$62.75	\$58.37				
					10	PE7057-10	\$72.96	\$67.85	\$62.75	\$58.37				
					BNC	4,000	1	PE7050-1	\$101.13	\$94.05		\$86.97	\$80.90	51
							2	PE7050-2	\$101.13	\$94.05		\$86.97	\$80.90	
							3	PE7050-3	\$101.13	\$94.05		\$86.97	\$80.90	
							6	PE7050-6	\$101.13	\$94.05		\$86.97	\$80.90	
10	PE7050-10	\$101.13	\$94.05	\$86.97			\$80.90							
20	PE7050-20	\$101.13	\$94.05	\$86.97			\$80.90							
30	PE7050-30	\$101.13	\$94.05	\$86.97	\$80.90									

Attenuators

See Our Website For Real-Time Stock Availability!

Step Attenuators, Push Button

50 OHM



BNC

Max. Power	Connector	Max. Frequency (MHz.)	Construction Material	VSWR Max. (MHz)	Attenuation Range (dB)	Step Size (dB)	Model No	1-24	25-49	50-99	100+	ROW
1 WATT	BNC	750	Nickel Plated Brass	DC - 100: 1.10:1 100 - 500: 1.25:1 500 - 750: 1.40:1	0 - 45.5	0.5	PE7008-1	\$672.32	\$625.26	\$578.20	\$537.86	52
2 WATT	BNC	750	Nickel Plated Brass	DC - 100: 1.10:1 100 - 500: 1.25:1 500 - 750: 1.40:1	0 - 45.5	0.5	PE7008-2	\$686.76	\$638.69	\$590.61	\$549.41	
3 WATT	BNC	750	Nickel Plated Brass	DC - 100: 1.10:1 100 - 300: 1.20:1 300 - 500: 1.30:1	0 - 45.5	0.5	PE7008-3	\$672.32	\$625.26	\$578.20	\$537.86	
4 WATT	BNC	750	Nickel Plated Brass	DC - 100: 1.10:1 100 - 300: 1.20:1 300 - 500: 1.30:1	0 - 45.5	0.5	PE7008-4	\$672.32	\$625.26	\$578.20	\$537.86	
5 WATT	BNC	750	Nickel Plated Brass	1.40:1	0 - 45.5	0.5	PE7008-5	\$859.84	\$799.65	\$739.46	\$687.87	
6 WATT	BNC	750	Nickel Plated Brass	1.40:1	0 - 45.5	0.5	PE7008-6	\$859.84	\$799.65	\$739.46	\$687.87	

Attenuators

Step Attenuators, Dial

50 OHM

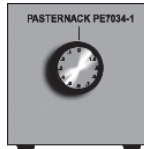

BNC

Max. Power	Connector	Max. Frequency (MHz.)	Construction Material	VSWR Max. (MHz)	Attenuation Range (dB)	Step Size (dB)	Model No	1-24	25-49	50-99	100+	ROW
1 WATT	BNC	1,000	Aluminum	1.20:1	0 - 1	0.1	PE7034-1	\$321.47	\$298.97	\$276.46	\$257.18	53
			Nickel Plated Brass	DC - 30: 1.10:1 30 - 500: 1.30:1 500 - 1,000: 1.50:1	0 - 81	0.1	PE7058-1	\$1,375.61	\$1,279.32	\$1,183.02	\$1,100.49	54
			Aluminum	1.20:1	0 - 100	10	PE7034-2	\$393.41	\$365.87	\$338.33	\$314.73	55
				1.30:1	0 - 1	0.1	PE7034-6	\$370.87	\$344.91	\$318.95	\$296.70	
		DC - 1,000: 1.20:1 1,000 - 2,000: 1.40:1		0 - 10	1	PE7034-3	\$311.89	\$290.06	\$268.23	\$249.51		
		0 - 70		10	PE7034-4	\$421.79	\$392.26	\$362.74	\$337.43			
		2,000	DC - 1,000: 1.30:1 1,000 - 1,500: 1.50:1 1,500 - 2,000: 1.70:1	0 - 80	1	PE7033-2	\$688.33	\$640.15	\$591.96	\$550.66	56	
			DC - 1,000: 1.30:1 1,000 - 2,000: 1.50:1	0 - 100	10	PE7034-5	\$527.42	\$490.50	\$453.58	\$421.94	57	
DC - 1,000: 1.30:1 1,000 - 1,500: 1.50:1 1,500 - 2,000: 1.70:1	0 - 110		1	PE7033	\$749.94	\$697.44	\$644.95	\$599.95	58			

See Our Website For Real-Time Stock Availability!

Step Attenuators, Dial

75 OHM

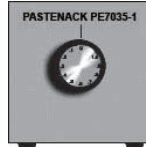

BNC

Max. Power	Connector	Max. Frequency (MHz.)	Construction Material	VSWR Max. (MHz)	Attenuation Range (dB)	Step Size (dB)	Model No	1-24	25-49	50-99	100+	ROW
1 WATT	BNC	500	Aluminum	1.30:1	0 - 1	0.1	PE7035-1	\$337.18	\$313.58	\$289.97	\$269.74	59
					0 - 10	1	PE7035-2	\$337.18	\$313.58	\$289.97	\$269.74	
					0 - 70	10	PE7035-3	\$337.18	\$313.58	\$289.97	\$269.74	
		1,000		DC - 500: 1.30:1 500 - 1,000: 1.40:1	0 - 1	0.1	PE7035-5	\$347.66	\$323.32	\$298.99	\$278.13	
				DC - 500: 1.30:1 500 - 1,000: 1.40:1	0 - 10	1	PE7035-4	\$347.66	\$323.32	\$298.99	\$278.13	

Step Attenuators, Toggle

50 OHM

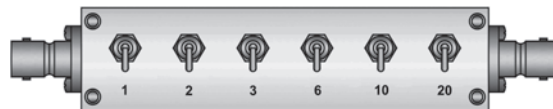

BNC

Max. Power	Connector	Max. Frequency (MHz.)	Construction Material	VSWR Max. (MHz)	Attenuation Range (dB)	Step Size (dB)	Model No	1-24	25-49	50-99	100+	ROW
1 WATT	BNC	500	Aluminum	1.50:1	0 - 42	1	PE7037-1	\$1,721.09	\$1,600.61	\$1,480.14	\$1,376.87	60
					0 - 82.5	0.5	PE7037-2	\$2,023.31	\$1,881.68	\$1,740.05	\$1,618.65	
		1,000		1.40:1	0 - 42	0.5	PE7036-1	\$672.32	\$625.26	\$578.20	\$537.86	61
					0 - 82.5	0.5	PE7036-2	\$672.32	\$625.26	\$578.20	\$537.86	
					0 - 102	1	PE7036-3	\$681.24	\$633.55	\$585.87	\$544.99	

75 OHM



BNC

Max. Power	Connector	Max. Frequency (MHz.)	Construction Material	VSWR Max. (MHz)	Attenuation Range (dB)	Step Size (dB)	Model No	1-24	25-49	50-99	100+	ROW
1 WATT	BNC	1,000	Aluminum	1.40:1	0 - 42	1	PE7038-1	\$618.21	\$574.94	\$531.66	\$494.57	62
					0 - 82.5	0.5	PE7038-2	\$606.16	\$563.73	\$521.30	\$484.93	
2 WATT	BNC	1,000	Aluminum	1.40:1	0 - 102	1	PE7038-3	\$644.81	\$599.67	\$554.54	\$515.85	

Attenuators

See Our Website For Real-Time Stock Availability!



Free Freight Available
via UPS Ground
to USA & Canada



Real-Time Stock
Levels & Pricing
On Our WebSite



Toll-Free Technical
Support
(866) 727-8376



Same-Day Shipping,
Even Custom
Cable Assemblies

Programmable Attenuators

50 OHM



SMA

Max. Power	Connector	Max. Frequency (MHz.)	Construction Material	VSWR Max. (MHz)	Attenuation Range (dB)	Step Size (dB)	Model No	1-24	25-49	50-99	100+	ROW
0.5 WATT	SMA	1,000	Aluminum	1.40:1	0 - 63	1	PE7011-6A	\$730.59	\$679.45	\$628.31	\$584.47	63

DC Bias Attenuators

50 OHM



SMA

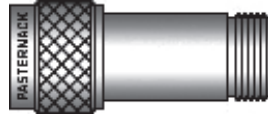

N

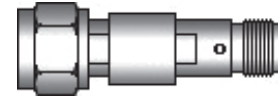

TNC

Max. Power	Connector	Frequency Range (MHz.)	Construction Material	VSWR Max. (MHz)	Max. V (V)	Max. I (Amp)	Attenuation (dB)	Model No	1-24	25-49	50-99	100+	ROW
2 WATT	SMA	500 - 2,000	Stainless Steel	1.35:1	100	2	6	PE7061-6	\$75.14	\$69.88	\$64.62	\$60.11	64
							10	PE7061-10	\$75.14	\$69.88	\$64.62	\$60.11	
							20	PE7061-20	\$76.76	\$71.39	\$66.01	\$61.41	
	N	500 - 2,000	Stainless Steel	1.35:1	100	2	6	PE7062-6	\$86.94	\$80.85	\$74.77	\$69.55	65
							10	PE7062-10	\$86.94	\$80.85	\$74.77	\$69.55	
							20	PE7062-20	\$91.25	\$84.86	\$78.48	\$73.00	
	TNC	500 - 2,000	Stainless Steel	1.35:1	100	2	6	PE7063-6	\$99.76	\$92.78	\$85.79	\$79.81	66
							10	PE7063-10	\$99.76	\$92.78	\$85.79	\$79.81	
							20	PE7063-20	\$102.95	\$95.74	\$88.54	\$82.36	

75 OHM



F

Max. Power	Connector	Frequency Range (MHz.)	Construction Material	VSWR Max. (MHz)	Max. V (V)	Max. I (Amp)	Attenuation (dB)	Model No	1-24	25-49	50-99	100+	ROW
2 WATT	F	500 - 2,000	Stainless Steel	1.45:1	100	2	6	PE7064-6	\$106.90	\$99.42	\$91.93	\$85.52	67
							10	PE7064-10	\$106.90	\$99.42	\$91.93	\$85.52	
	SMA	500 - 2,000	Stainless Steel	1.45:1	100	2	20	PE7064-20	\$106.90	\$99.42	\$91.93	\$85.52	

The 60 GHz frequency is an “unlicensed” band and does not require a transmitting license from the Federal Communications Commission (FCC).

Attenuators

See Our Website For Real-Time Stock Availability!

Continuously Variable Attenuators

50 OHM

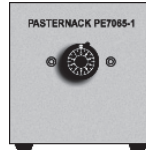

SMA

Max. Power	Connector	Freq. Range (MHz.)	Construction Material	VSWR Max.	Attenuation Range (dB)	Model No	1-24	25-49	50-99	100+	ROW
5 WATT	SMA	1,000 - 2,000	Aluminum	2.00:1	7	PE7065-1	\$459.23	\$427.08	\$394.94	\$367.38	68
					10	PE7065-2	\$459.23	\$427.08	\$394.94	\$367.38	
		2,000 - 4,000		1.80:1	20	PE7065-3	\$483.90	\$450.03	\$416.15	\$387.12	
					10	PE7065-4	\$463.08	\$430.66	\$398.25	\$370.46	
		4,000 - 8,000		1.50:1	20	PE7065-5	\$483.90	\$450.03	\$416.15	\$387.12	
					30	PE7065-6	\$546.78	\$508.51	\$470.23	\$437.42	
		8,000 - 12,400		1.70:1	10	PE7065-7	\$508.58	\$472.98	\$437.38	\$406.86	
					20	PE7065-8	\$561.98	\$522.64	\$483.30	\$449.58	
					30	PE7065-9	\$561.98	\$522.64	\$483.30	\$449.58	
					40	PE7065-10	\$561.98	\$522.64	\$483.30	\$449.58	
		12,400 - 18,000		1.50:1	10	PE7065-11	\$561.98	\$522.64	\$483.30	\$449.58	
					20	PE7065-12	\$561.98	\$522.64	\$483.30	\$449.58	
					30	PE7065-13	\$561.98	\$522.64	\$483.30	\$449.58	
					40	PE7065-14	\$587.71	\$546.57	\$505.43	\$470.17	

TERMINATIONS

RF Load

50 OHM

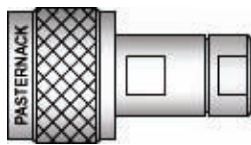

N Male

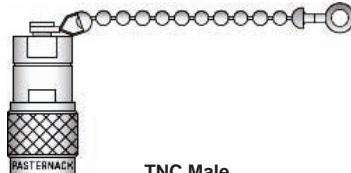

TNC Male



BNC Male

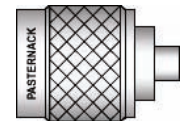

TNC Female

Max. Power	Connector	Max. Freq. (MHz.)	Construction Material	VSWR Max.	Chain	Model No	1-24	25-49	50-99	100+	ROW
0.5 WATT	SMA Male	12,400	Stainless Steel	1.17:1	No	PE6002	\$40.03	\$37.23	\$34.43	\$32.02	1
					Yes	PE6069	\$43.17	\$40.15	\$37.13	\$34.54	2
	SMA Female	40,000	1.20:1	No	PE6003	\$36.28	\$33.74	\$31.20	\$29.02	3	
					Yes	PE6070	\$42.25	\$39.29	\$36.34	\$33.80	4
	2.92mm Male	1,000	Brass	No	PE6085	\$307.94	\$286.38	\$264.83	\$246.35	5	
					Yes	PE6086	\$312.50	\$290.63	\$268.75	\$250.00	6
	2.92mm Female	1,000	Yes	No	PE6088	\$329.68	\$306.60	\$283.52	\$263.74	7	
					Yes	PE6001-50	\$18.09	\$16.82	\$15.56	\$14.47	8
	N Male	1,000	Brass	No	PE6062-50	\$21.48	\$19.98	\$18.47	\$17.18	9	
					Yes	PE6028-50	\$19.05	\$17.72	\$16.38	\$15.24	10
	N Female	1,000	Yes	No	PE6065-50	\$25.08	\$23.32	\$21.57	\$20.06	11	
					Yes	PE6011-50	\$17.88	\$16.63	\$15.38	\$14.30	12
	TNC Male	1,000	Yes	No	PE6063-50	\$23.86	\$22.19	\$20.52	\$19.09	13	
					Yes	PE6029-50	\$20.72	\$19.27	\$17.82	\$16.58	14
	TNC Female	1,000	Yes	No	PE6066-50	\$25.08	\$23.32	\$21.57	\$20.06	15	
					Yes	PE6146	\$67.54	\$62.81	\$58.08	\$54.03	16
	7/16 DIN Male	40,000	Stainless Steel	1.35:1	No	PE6049	\$21.48	\$19.98	\$18.47	\$17.18	17
					Yes	PE6050	\$21.48	\$19.98	\$18.47	\$17.18	18
	SMC Plug	1,000	Brass	No	PE6163	\$176.57	\$164.21	\$151.85	\$141.26	19	
					Yes	PE6162	\$176.57	\$164.21	\$151.85	\$141.26	20
	SMC Jack	1,000	No	No	PE6044	\$21.48	\$19.98	\$18.47	\$17.18	21	
					Yes	PE6045	\$27.51	\$25.58	\$23.66	\$22.01	22
	MINI SMP Male	1,000	Yes	No	PE6000-50	\$17.28	\$16.07	\$14.86	\$13.82	23	
					Yes	PE6061-50	\$20.32	\$18.90	\$17.48	\$16.26	24
	MINI SMP Female	1,000	No	No	PE6027-50	\$17.88	\$16.63	\$15.38	\$14.30	25	
					Yes	PE6064-50	\$23.86	\$22.19	\$20.52	\$19.09	26
	SMB Plug	1,000	Yes	No	PE6145	\$38.25	\$35.57	\$32.90	\$30.60	27	
					Yes	PE6147	\$41.80	\$38.87	\$35.95	\$33.44	28
SMB Jack	1,000	No	No	PE6145	\$38.25	\$35.57	\$32.90	\$30.60	27		
				Yes	PE6147	\$41.80	\$38.87	\$35.95	\$33.44	28	
BNC Male	1,000	Brass	No	PE6000-50	\$17.28	\$16.07	\$14.86	\$13.82	23		
				Yes	PE6061-50	\$20.32	\$18.90	\$17.48	\$16.26	24	
BNC Female	1,000	No	No	PE6027-50	\$17.88	\$16.63	\$15.38	\$14.30	25		
				Yes	PE6064-50	\$23.86	\$22.19	\$20.52	\$19.09	26	
C Male	1,000	Yes	No	PE6145	\$38.25	\$35.57	\$32.90	\$30.60	27		
				Yes	PE6147	\$41.80	\$38.87	\$35.95	\$33.44	28	

Terminations & Matching Pads

See Our Website For Real-Time Stock Availability!

Free Freight Available via UPS Ground to USA & Canada



Real-Time Stock Levels & Pricing On Our WebSite



Toll-Free Technical Support (866) 727-8376



Same-Day Shipping, Even Custom Cable Assemblies

RF Load

50 OHM

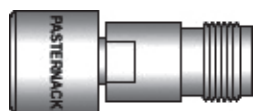

TNC Female

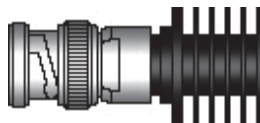

BNC Male

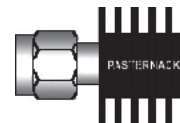

SMA Male

Max. Power	Connector	Max. Freq. (MHz.)	Construction Material	VSWR Max.	Chain	Model No	1-24	25-49	50-99	100+	Row			
1 WATT	SMA Male	1,000	Brass	1.05:1	No	PE6148	\$18.09	\$16.82	\$15.56	\$14.47	1			
		2,500		1.10:1	No	PE6149	\$21.61	\$20.10	\$18.58	\$17.29	2			
		4,000	Brass	1.10:1	No	PE6150	\$23.41	\$21.77	\$20.13	\$18.73	3			
		8,000		1.15:1	No	PE6151	\$26.80	\$24.92	\$23.05	\$21.44	4			
	SMA Female	18,000	Stainless Steel	1.20:1	No	PE6071	\$45.04	\$41.89	\$38.73	\$36.03	5			
				Yes	PE6072	\$53.00	\$49.29	\$45.58	\$42.40	6				
		26,500		1.25:1	No	PE6077	\$77.42	\$72.00	\$66.58	\$61.94	7			
				Yes	PE6078	\$78.68	\$73.17	\$67.66	\$62.94	8				
		18,000		1.20:1	No	PE6073	\$52.18	\$48.53	\$44.87	\$41.74	9			
				Yes	PE6074	\$64.09	\$59.60	\$55.12	\$51.27	10				
		26,500		1.35:1	No	PE6079	\$78.68	\$73.17	\$67.66	\$62.94	11			
				Yes	PE6080	\$86.13	\$80.10	\$74.07	\$68.90	12				
		2.92mm Male		40,000	1.25:1	No	PE6173	\$182.29	\$169.53	\$156.77	\$145.83	13		
		Yes			PE6174	\$192.43	\$178.96	\$165.49	\$153.94	14				
2.92mm Female	50,000	1.45:1	No	PE6175	\$192.43	\$178.96	\$165.49	\$153.94	15					
Yes		PE6178	\$455.99	\$424.07	\$392.15	\$364.79	16							
2.4mm Male	50,000	1.45:1	No	PE6179	\$363.77	\$338.31	\$312.84	\$291.02	17					
Yes		PE6180	\$353.64	\$328.89	\$304.13	\$282.91	18							
2.4mm Female	12,400	Brass	1.30:1	No	PE6164	\$18.44	\$17.15	\$15.86	\$14.75	19				
QMA Male			1.25:1	No	PE6161	\$147.08	\$136.78	\$126.49	\$117.66	20				
SMP Male	10,000	18,000	1.25:1	No	PE6160	\$148.14	\$137.77	\$127.40	\$118.51	21				
SMP Female	18,000		No	PE6081	\$47.57	\$44.24	\$40.91	\$38.06	22					
2 WATT	SMA Male	18,000	Stainless Steel	1.20:1	Yes	PE6082	\$55.28	\$51.41	\$47.54	\$44.22	23			
				No	PE6083	\$48.33	\$44.95	\$41.56	\$38.66	24				
	2.92mm Male			1.25:1	Yes	PE6084	\$58.87	\$54.75	\$50.63	\$47.10	25			
				No	PE6176	\$258.39	\$240.30	\$222.22	\$206.71	26				
	1,000			Brass	1.05:1	No	PE6152	\$20.32	\$18.90	\$17.48	\$16.26	28		
					2,000	1.10:1	No	PE6153	\$22.60	\$21.02	\$19.44	\$18.08	29	
	4,000			18,000	1.30:1	No	PE6154	\$25.38	\$23.60	\$21.83	\$20.30	30		
						Yes	PE6009	\$43.22	\$40.19	\$37.17	\$34.58	31		
	N Female			18,000	1.30:1	Yes	PE6075	\$49.65	\$46.17	\$42.70	\$39.72	32		
						No	PE6032	\$56.80	\$52.82	\$48.85	\$45.44	33		
2,000	TNC Male	18,000	1.15:1	Yes	PE6076	\$76.40	\$71.05	\$65.70	\$61.12	34				
				No	PE6157	\$20.52	\$19.08	\$17.65	\$16.42	35				
4,000	TNC Male	18,000	1.15:1	No	PE6158	\$22.95	\$21.34	\$19.74	\$18.36	36				
				Yes	PE6089	\$98.54	\$91.64	\$84.74	\$78.83	37				
TNC Female	18,000	Stainless Steel	1.25:1	Yes	PE6090	\$103.05	\$95.84	\$88.62	\$82.44	38				
				No	PE6091	\$91.05	\$84.68	\$78.30	\$72.84	39				
1,000	BNC Male	Brass	1.10:1	Yes	PE6092	\$97.07	\$90.28	\$83.48	\$77.66	40				
				No	PE6155	\$19.20	\$17.86	\$16.51	\$15.36	41				
4,000	BNC Male	1.35:1	No	PE6156	\$20.32	\$18.90	\$17.48	\$16.26	42					
			No	PE6095	\$93.73	\$87.17	\$80.61	\$74.98	43					
5 WATT	SMA Male	18,000	Stainless Steel	1.25:1	No	PE6096	\$123.52	\$114.87	\$106.23	\$98.82	44			
					Yes	PE6097	\$89.53	\$83.26	\$77.00	\$71.62	45			
	N Male				No	PE6098	\$91.05	\$84.68	\$78.30	\$72.84	46			
					Yes	PE6099	\$115.67	\$107.57	\$99.48	\$92.54	47			
	TNC Male				No	PE6138	\$117.64	\$109.41	\$101.17	\$94.11	48			
					Yes	PE6100	\$117.64	\$109.41	\$101.17	\$94.11	49			
	7/16 DIN Male				7,000	Brass	1.25:1	No	PE6139	\$117.64	\$109.41	\$101.17	\$94.11	50
								Yes	PE6036	\$172.21	\$160.16	\$148.10	\$137.77	51
	SMA Female				18,000	Aluminum Heatsink	1.40:1	No	PE6103	\$168.51	\$156.71	\$144.92	\$134.81	52
								Yes	PE6035	\$196.48	\$182.73	\$168.97	\$157.18	53
N Female	18,000	1.25:1	No	PE6102	\$201.75	\$187.63	\$173.51	\$161.40	54					
			Yes	PE6104	\$211.68	\$196.86	\$182.04	\$169.34	55					
TNC Male	7,000	1.40:1	No	PE6140	\$215.28	\$200.21	\$185.14	\$172.22	56					
			Yes	PE6105	\$233.77	\$217.41	\$201.04	\$187.02	57					
7/16 DIN Male	7,000	1.25:1	No	PE6141	\$233.77	\$217.41	\$201.04	\$187.02	58					
			Yes	PE6034	\$128.18	\$119.21	\$110.23	\$102.54	59					
BNC Male	4,000	1.25:1	No	PE6101	\$163.14	\$151.72	\$140.30	\$130.51	60					
			Yes	PE6038	\$347.31	\$323.00	\$298.69	\$277.85	61					
SMA Female	18,000	Aluminum Heatsink	1.40:1	No	PE6106	\$312.50	\$290.63	\$268.75	\$250.00	62				
				Yes	PE6037	\$412.06	\$383.22	\$354.37	\$329.65	63				
25 WATT	N Male	18,000	1.25:1	No	PE6107	\$353.24	\$328.51	\$303.79	\$282.59	64				
				Yes	PE6107	\$353.24	\$328.51	\$303.79	\$282.59	64				

Terminations & Matching Pads

See Our Website For Real-Time Stock Availability!

RF Load

50 OHM

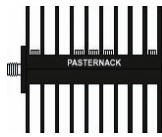

SMA Female



N Female



7/16 DIN Female

Max. Power	Connector	Max. Freq. (MHz.)	Construction Material	VSWR Max.	Chain	Model No	1-24	25-49	50-99	100+	ROW
50 WATT	SMA Female	18,000	Aluminum Heatsink	1.45:1	No	PE6040	\$436.38	\$405.83	\$375.29	\$349.10	1
	N Male	4,000		1.25:1	No	PE6167	\$376.39	\$350.04	\$323.70	\$301.11	2
	N Female	18,000		1.45:1	No	PE6039	\$429.39	\$399.33	\$369.28	\$343.51	3
	7/16 DIN Female	7,000		1.35:1	No	PE6112	\$441.70	\$410.78	\$379.86	\$353.36	4
100 WATT	SMA Male	4,000	Aluminum Heatsink	1.25:1	No	PE6166	\$376.39	\$350.04	\$323.70	\$301.11	5
	SMA Female	2,000		1.30:1	No	PE6043	\$694.67	\$646.04	\$597.42	\$555.74	6
	N Male	4,000		1.25:1	No	PE6168	\$672.22	\$625.16	\$578.11	\$537.78	7
	N Female	2,000			No	PE6042	\$675.82	\$628.51	\$581.21	\$540.66	8
	7/16 DIN Male	4,000			No	PE6169	\$403.29	\$375.06	\$346.83	\$322.63	9
	7/16 DIN Female	2,000			No	PE6137	\$714.83	\$664.79	\$614.75	\$571.86	10
	BNC Female			No	PE6041	\$649.63	\$604.16	\$558.68	\$519.70	11	

75 OHM

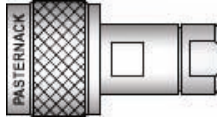

N Male

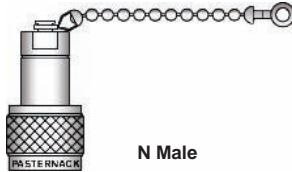

N Male



N Female

Max. Power	Connector	Max. Freq. (MHz.)	Construction Material	VSWR Max.	Chain	Model No	1-24	25-49	50-99	100+	ROW
0.25 WATT	BNC Male	3,000	Brass	1.25:1	No	PE6165	\$17.78	\$16.54	\$15.29	\$14.22	12
0.5 WATT	N Male	1,000	Brass	1.25:1	No	PE6047	\$21.48	\$19.98	\$18.47	\$17.18	13
					Yes	PE6067	\$27.51	\$25.58	\$23.66	\$22.01	14
	N Female				No	PE6048	\$28.02	\$26.06	\$24.10	\$22.42	15
					Yes	PE6068	\$31.06	\$28.89	\$26.71	\$24.85	16
	TNC Male				No	PE6011-75	\$17.88	\$16.63	\$15.38	\$14.30	17
	SMC Plug				Yes	PE6063-75	\$23.86	\$22.19	\$20.52	\$19.09	18
					No	PE6055	\$27.51	\$25.58	\$23.66	\$22.01	19
	SMC Jack				No	PE6056	\$34.60	\$32.18	\$29.76	\$27.68	20
	SMB Plug				No	PE6053	\$27.51	\$25.58	\$23.66	\$22.01	21
					No	PE6054	\$34.60	\$32.18	\$29.76	\$27.68	22
	SMB Jack				No	PE6159	\$25.08	\$23.32	\$21.57	\$20.06	23
	MINI SMB Male				No	PE6051	\$23.15	\$21.53	\$19.91	\$18.52	24
	BNC Male				Yes	PE6093	\$30.75	\$28.60	\$26.45	\$24.60	25
					No	PE6052	\$21.48	\$19.98	\$18.47	\$17.18	26
					Yes	PE6094	\$27.51	\$25.58	\$23.66	\$22.01	27

93 OHM

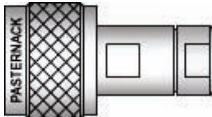

N Male

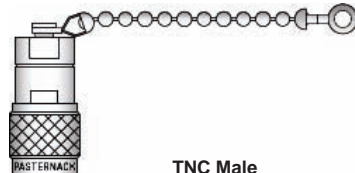

TNC Male

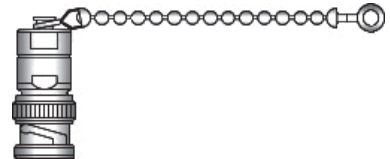

BNC Male

Max. Power	Connector	Max. Freq. (MHz.)	Construction Material	VSWR Max.	Chain	Model No	1-24	25-49	50-99	100+	ROW
0.5 WATT	N Male	1,000	Brass	1.25:1	No	PE6001-93	\$18.09	\$16.82	\$15.56	\$14.47	28
					Yes	PE6062-93	\$21.48	\$19.98	\$18.47	\$17.18	29
	TNC Male				No	PE6011-93	\$17.88	\$16.63	\$15.38	\$14.30	30
					Yes	PE6063-93	\$23.86	\$22.19	\$20.52	\$19.09	31
BNC Male	No	PE6000-93	\$17.28	\$16.07	\$14.86	\$13.82	32				

Terminations & Matching Pads

See Our Website For Real-Time Stock Availability!

Free Freight Available via UPS Ground to USA & Canada



Real-Time Stock Levels & Pricing On Our WebSite



Toil-Free Technical Support (866) 727-8376



Same-Day Shipping, Even Custom Cable Assemblies

RF Load

93 OHM

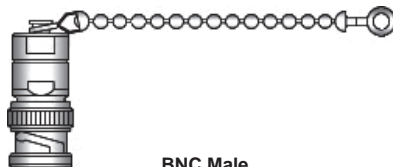

BNC Male

Max. Power	Connector	Max. Freq. (MHz.)	Construction Material	VSWR Max.	Chain	Model No	1-24	25-49	50-99	100+	ROW
0.5 WATT	BNC Male	1,000	Brass		Yes	PE6061-93	\$20.32	\$18.90	\$17.48	\$16.26	1

Feed-Thru Load

50 OHM

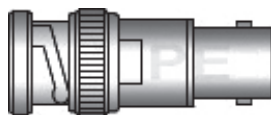

BNC Male



SMA Male



N Male

Max. Power	Connector	Max. Freq. (MHz.)	Construction Material	VSWR Max.	Chain	Model No	1-24	25-49	50-99	100+	ROW
1 WATT	TNC Male	1,000	Brass		No	PE6142-50	\$41.80	\$38.87	\$35.95	\$33.44	2
	BNC Male				No	PE6008-50	\$31.06	\$28.89	\$26.71	\$24.85	3
2 WATT	SMA Male	1,000	Stainless Steel		No	PE6026	\$65.41	\$60.83	\$56.25	\$52.33	4
	N Male		Brass		No	PE6033	\$76.40	\$71.05	\$65.70	\$61.12	5

75 OHM

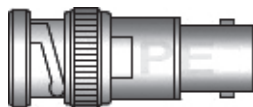

BNC Male

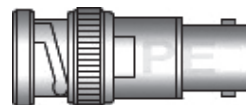

BNC Male

Max. Power	Connector	Max. Freq. (MHz.)	Construction Material	VSWR Max.	Chain	Model No	1-24	25-49	50-99	100+	ROW
1 WATT	TNC Male	1,000	Brass		No	PE6142-75	\$41.80	\$38.87	\$35.95	\$33.44	6
	BNC Male				No	PE6008-75	\$31.06	\$28.89	\$26.71	\$24.85	7

MATCHING PADS

Resistive Impedance Transformers



N Female

Model No	Connector B 50 Ω	Connector B 75 Ω	Max. Frequency (MHz.)	VSWR Max.	Attenuation Loss (dB)	Accuracy (dB)	1-24	25-49	50-99	100+	ROW
PE7027	N Male	N Female	500	1.20:1	5.7	± .5	\$78.63	\$73.13	\$67.62	\$62.90	8

Terminations & Matching Pads

See Our Website For Real-Time Stock Availability!

Resistive Impedance Transformers



N Female

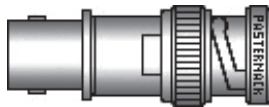

BNC Male

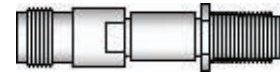

TNC Female

Model No	Connector B 50 Ω	Connector B 75 Ω	Max. Frequency (MHz.)	VSWR Max.	Attenuation Loss (dB)	Accuracy (dB)	1-24	25-49	50-99	100+	ROW
PE7028	N Female	N Male	1,000	1.20:1	5.7	± .5	\$78.63	\$73.13	\$67.62	\$62.90	1
PE7006	BNC Male	BNC Female	1,000	1.20:1	5.7	± .5	\$40.38	\$37.55	\$34.73	\$32.30	2
PE7007	BNC Female	BNC Male	1,000	1.20:1	5.7	± .5	\$40.38	\$37.55	\$34.73	\$32.30	3
PE7075	SMA Male	F Male	3,000	1.25:1	5.7	± .5	\$82.33	\$76.57	\$70.80	\$65.86	4
PE7076	SMA Male	F Female	3,000	1.25:1	5.7	± .5	\$80.96	\$75.29	\$69.63	\$64.77	5
PE7077	SMA Female	F Male	3,000	1.25:1	5.7	± .5	\$80.20	\$74.59	\$68.97	\$64.16	6
PE7078	SMA Female	F Female	3,000	1.25:1	5.7	± .5	\$80.96	\$75.29	\$69.63	\$64.77	7
PE7070	N Male	N Female	3,000	1.35:1	5.7	± .5	\$80.96	\$75.29	\$69.63	\$64.77	8
PE7072	N Male	F Male	3,000	1.25:1	5.7	± .5	\$82.33	\$76.57	\$70.80	\$65.86	9
PE7071	N Male	F Female	3,000	1.25:1	5.7	± .5	\$80.20	\$74.59	\$68.97	\$64.16	10
PE7083	N Female	N Male	3,000	1.35:1	5.7	± .5	\$86.23	\$80.19	\$74.16	\$68.98	11
PE7073	N Female	F Male	3,000	1.25:1	5.7	± .5	\$80.20	\$74.59	\$68.97	\$64.16	12
PE7074	N Female	F Female	3,000	1.25:1	5.7	± .5	\$80.96	\$75.29	\$69.63	\$64.77	13
PE7080	TNC Male	F Male	3,000	1.25:1	5.7	± .5	\$88.16	\$81.99	\$75.82	\$70.53	14
PE7079	TNC Male	F Female	3,000	1.25:1	5.7	± .5	\$88.16	\$81.99	\$75.82	\$70.53	15
PE7081	TNC Female	F Male	3,000	1.25:1	5.7	± .5	\$88.16	\$81.99	\$75.82	\$70.53	16
PE7082	TNC Female	F Female	3,000	1.25:1	5.7	± .5	\$88.16	\$81.99	\$75.82	\$70.53	17
PE7067	BNC Male	F Male	3,000	1.25:1	5.7	± .5	\$82.33	\$76.57	\$70.80	\$65.86	18
PE7066	BNC Male	F Female	3,000	1.25:1	5.7	± .5	\$80.96	\$75.29	\$69.63	\$64.77	19
PE7068	BNC Female	F Male	3,000	1.25:1	5.7	± .5	\$84.61	\$78.69	\$72.76	\$67.69	20
PE7069	BNC Female	F Female	3,000	1.25:1	5.7	± .5	\$82.33	\$76.57	\$70.80	\$65.86	21

See Our Website For Real-Time Stock Availability!

Couplers and Dividers

COUPLERS

Single Directional

SMA Connectors

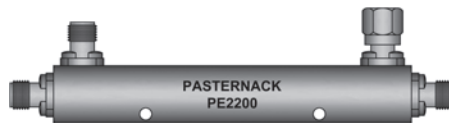

Frequency Range (MHz.)	Coupling (dB)	Maximum Power	Directivity (dB)	Model No	1-24	25-49	50-99	100+	ROW
500 - 1,000	6	50 Watt	25	PE2200-6	\$280.99	\$261.32	\$241.65	\$224.79	22
	10			PE2200-10	\$280.99	\$261.32	\$241.65	\$224.79	
	20			PE2200-20	\$280.99	\$261.32	\$241.65	\$224.79	
	30			PE2200-30	\$280.99	\$261.32	\$241.65	\$224.79	
500 - 2,000	6	50 Watt	23	PE2208-6	\$370.87	\$344.91	\$318.95	\$296.70	23
	10			PE2208-10	\$370.87	\$344.91	\$318.95	\$296.70	
	20			PE2208-20	\$370.87	\$344.91	\$318.95	\$296.70	
600 - 4,000	10	50 Watt	18	PE2213-10	\$561.98	\$522.64	\$483.30	\$449.58	24
800 - 2,500	6	50 Watt	20	PE2238-6	\$322.63	\$300.05	\$277.46	\$258.10	25
	10			PE2238-10	\$322.63	\$300.05	\$277.46	\$258.10	
	20			PE2238-20	\$322.63	\$300.05	\$277.46	\$258.10	
	30			PE2238-30	\$322.63	\$300.05	\$277.46	\$258.10	



Free Freight Available
via UPS Ground
to USA & Canada



Real-Time Stock
Levels & Pricing
On Our WebSite



Toil-Free Technical
Support
(866) 727-8376



Same-Day Shipping,
Even Custom
Cable Assemblies

Single Directional

SMA Connectors

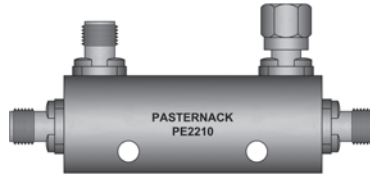

See Our Website For Real-Time Stock Availability!

Couplers and Dividers

Frequency Range (MHz.)	Coupling (dB)	Maximum Power	Directivity (dB)	Model No	1-24	25-49	50-99	100+	ROW
1,000 - 2,000	6	50 Watt	25	PE2201-6	\$280.99	\$261.32	\$241.65	\$224.79	1
	10			PE2201-10	\$280.99	\$261.32	\$241.65	\$224.79	
	20			PE2201-20	\$280.99	\$261.32	\$241.65	\$224.79	
	30			PE2201-30	\$280.99	\$261.32	\$241.65	\$224.79	
1,000 - 4,000	6	50 Watt	23	PE2209-6	\$370.87	\$344.91	\$318.95	\$296.70	2
	10			PE2209-10	\$370.87	\$344.91	\$318.95	\$296.70	
	20			PE2209-20	\$382.01	\$355.27	\$328.53	\$305.61	
1,000 - 18,000	10	25 Watt	15	PE2214-10	\$1,348.85	\$1,254.43	\$1,160.01	\$1,079.08	3
	16			PE2214-16	\$1,348.85	\$1,254.43	\$1,160.01	\$1,079.08	
	20			PE2214-20	\$1,348.85	\$1,254.43	\$1,160.01	\$1,079.08	
2,000 - 4,000	6	50 Watt	22	PE2202-6	\$280.99	\$261.32	\$241.65	\$224.79	4
	10			PE2202-10	\$280.99	\$261.32	\$241.65	\$224.79	
	20			PE2202-20	\$280.99	\$261.32	\$241.65	\$224.79	
	30			PE2202-30	\$280.99	\$261.32	\$241.65	\$224.79	
2,000 - 8,000	6	50 Watt	20	PE2210-6	\$385.05	\$358.10	\$331.14	\$308.04	5
	10			PE2210-10	\$370.87	\$344.91	\$318.95	\$296.70	
	20			PE2210-20	\$370.87	\$344.91	\$318.95	\$296.70	
2,000 - 18,000	6	25 Watt	15	PE2215-6	\$1,348.85	\$1,254.43	\$1,160.01	\$1,079.08	6
	10			PE2215-10	\$1,348.85	\$1,254.43	\$1,160.01	\$1,079.08	
	16			PE2215-16	\$1,348.85	\$1,254.43	\$1,160.01	\$1,079.08	
	20			PE2215-20	\$1,348.85	\$1,254.43	\$1,160.01	\$1,079.08	
2,600 - 5,200	6	50 Watt	20	PE2203-6	\$280.99	\$261.32	\$241.65	\$224.79	7
	10			PE2203-10	\$280.99	\$261.32	\$241.65	\$224.79	
	20			PE2203-20	\$280.99	\$261.32	\$241.65	\$224.79	
	30			PE2203-30	\$280.99	\$261.32	\$241.65	\$224.79	
4,000 - 8,000	6	50 Watt	20	PE2204-6	\$293.86	\$273.29	\$252.72	\$235.09	8
	10			PE2204-10	\$280.99	\$261.32	\$241.65	\$224.79	
	20			PE2204-20	\$280.99	\$261.32	\$241.65	\$224.79	
	30			PE2204-30	\$280.99	\$261.32	\$241.65	\$224.79	
4,000 - 12,400	6	50 Watt	17	PE2211-6	\$370.87	\$344.91	\$318.95	\$296.70	9
	10			PE2211-10	\$370.87	\$344.91	\$318.95	\$296.70	
	20			PE2211-20	\$370.87	\$344.91	\$318.95	\$296.70	
4,000 - 18,000	6	50 Watt	15	PE2216-6	\$561.98	\$522.64	\$483.30	\$449.58	10
	10			PE2216-10	\$561.98	\$522.64	\$483.30	\$449.58	
	20			PE2216-20	\$561.98	\$522.64	\$483.30	\$449.58	
7,000 - 12,400	6	50 Watt	17	PE2205-6	\$349.59	\$325.12	\$300.65	\$279.67	11
	10			PE2205-10	\$349.59	\$325.12	\$300.65	\$279.67	
	20			PE2205-20	\$349.59	\$325.12	\$300.65	\$279.67	
	30			PE2205-30	\$349.59	\$325.12	\$300.65	\$279.67	
7,000 - 18,000	10	50 Watt	15	PE2212-10	\$392.91	\$365.41	\$337.90	\$314.33	12
	10		12	PE2206-10	\$349.59	\$325.12	\$300.65	\$279.67	
7,500 - 16,000	20	50 Watt	15	PE2206-20	\$349.59	\$325.12	\$300.65	\$279.67	13
	30			PE2206-30	\$349.59	\$325.12	\$300.65	\$279.67	
	6			PE2207-6	\$360.08	\$334.87	\$309.67	\$288.06	
12,400 - 18,000	10	50 Watt	15	PE2207-10	\$360.08	\$334.87	\$309.67	\$288.06	14
	20			PE2207-20	\$360.08	\$334.87	\$309.67	\$288.06	
	30			PE2207-30	\$360.08	\$334.87	\$309.67	\$288.06	

N Connectors



Frequency Range (MHz.)	Coupling (dB)	Maximum Power	Directivity (dB)	Model No	1-24	25-49	50-99	100+	ROW
800 - 2,500	6	70 Watt	20	PE2237-6	\$322.63	\$300.05	\$277.46	\$258.10	15
	10			PE2237-10	\$322.63	\$300.05	\$277.46	\$258.10	
	20			PE2237-20	\$322.63	\$300.05	\$277.46	\$258.10	
	30			PE2237-30	\$322.63	\$300.05	\$277.46	\$258.10	
1,000 - 2,000	30	600 Watt	5	PE2226-30	\$999.87	\$929.88	\$859.89	\$799.90	16

ROHS & REACH COMPLIANT. CUSTOM-LENGTH CABLE ASSEMBLIES MAY BE ORDERED ON OUR WEBSITE.

Single Directional

N Connectors



Frequency Range (MHz.)	Coupling (dB)	Maximum Power	Directivity (dB)	Model No	1-24	25-49	50-99	100+	ROW
1,000 - 4,000	30	600 Watt	15	PE2228-30	\$1,396.99	\$1,299.20	\$1,201.41	\$1,117.59	1
1,000 - 8,000	30	50 Watt	15	PE2239-30	\$1,513.01	\$1,407.10	\$1,301.19	\$1,210.41	2
1,000 - 11,000	35	600 Watt	15	PE2236-35	\$1,910.93	\$1,777.16	\$1,643.40	\$1,528.74	3
1,500 - 4,500	30	600 Watt	18	PE2231-30	\$1,272.00	\$1,182.96	\$1,093.92	\$1,017.60	4
2,000 - 4,000	30	600 Watt	18	PE2227-30	\$1,123.04	\$1,044.43	\$965.81	\$898.43	5
2,000 - 8,000	30	600 Watt	16	PE2232-30	\$1,512.45	\$1,406.58	\$1,300.71	\$1,209.96	6
2,600 - 5,200	30	600 Watt	18	PE2229-30	\$946.62	\$880.36	\$814.09	\$757.30	7
4,000 - 8,000	30	600 Watt	18	PE2230-30	\$996.88	\$927.10	\$857.32	\$797.50	8
4,000 - 12,000	30	600 Watt	15	PE2235-30	\$1,272.00	\$1,182.96	\$1,093.92	\$1,017.60	9
5,000 - 11,000	30	600 Watt	15	PE2234-30	\$786.88	\$731.80	\$676.72	\$629.50	10
7,000 - 11,000	30	600 Watt	16	PE2233-30	\$946.62	\$880.36	\$814.09	\$757.30	11

Dual Directional

SMA Connectors

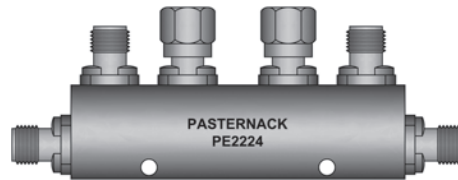

Frequency Range (MHz.)	Coupling (dB)	Maximum Power	Directivity (dB)	Model No	1-24	25-49	50-99	100+	ROW
500 - 1,000	10	10 Watt	22	PE2217-10	\$561.98	\$522.64	\$483.30	\$449.58	12
	20			PE2217-20	\$561.98	\$522.64	\$483.30	\$449.58	
	30			PE2217-30	\$561.98	\$522.64	\$483.30	\$449.58	
1,000 - 2,000	10	10 Watt	22	PE2218-10	\$561.98	\$522.64	\$483.30	\$449.58	13
	20			PE2218-20	\$561.98	\$522.64	\$483.30	\$449.58	
	30			PE2218-30	\$561.98	\$522.64	\$483.30	\$449.58	
2,000 - 4,000	10	10 Watt	20	PE2219-10	\$561.98	\$522.64	\$483.30	\$449.58	14
	20			PE2219-20	\$561.98	\$522.64	\$483.30	\$449.58	
	30			PE2219-30	\$561.98	\$522.64	\$483.30	\$449.58	
2,600 - 5,200	10	10 Watt	18	PE2220-10	\$561.98	\$522.64	\$483.30	\$449.58	14
	20			PE2220-20	\$561.98	\$522.64	\$483.30	\$449.58	
	30			PE2220-30	\$561.98	\$522.64	\$483.30	\$449.58	
4,000 - 8,000	10	10 Watt	18	PE2221-10	\$561.98	\$522.64	\$483.30	\$449.58	16
	20			PE2221-20	\$561.98	\$522.64	\$483.30	\$449.58	
	30			PE2221-30	\$561.98	\$522.64	\$483.30	\$449.58	
7,000 - 12,400	10	10 Watt	16	PE2222-10	\$561.98	\$522.64	\$483.30	\$449.58	17
	20			PE2222-20	\$561.98	\$522.64	\$483.30	\$449.58	
	30			PE2222-30	\$561.98	\$522.64	\$483.30	\$449.58	
8,000 - 16,000	10	10 Watt	15	PE2223-10	\$561.98	\$522.64	\$483.30	\$449.58	18
	20			PE2223-20	\$561.98	\$522.64	\$483.30	\$449.58	
	30			PE2223-30	\$561.98	\$522.64	\$483.30	\$449.58	
12,400 - 18,000	20	10 Watt	15	PE2224-20	\$561.98	\$522.64	\$483.30	\$449.58	19
	30			PE2224-30	\$561.98	\$522.64	\$483.30	\$449.58	

Couplers and Dividers

The C connector was invented by engineer Carl Concelman and is weatherproof.



Hybrids

SMA Connectors



Frequency Range (MHz.)	Coupling (dB)	Maximum Power	Directivity (dB)	Model No	1-24	25-49	50-99	100+	ROW
500 -1,000	3.1	50 Watt		PE2050	\$325.88	\$303.07	\$280.26	\$260.70	1
1,000 - 2,000	3.1	50 Watt		PE2051	\$341.38	\$317.48	\$293.59	\$273.10	2
2,000 - 4,000	3.1	50 Watt		PE2052	\$359.67	\$334.49	\$309.32	\$287.74	3
2,000 - 18,000	3.3	30 Watt		PE2058	\$408.66	\$380.05	\$351.45	\$326.93	4
2,600 - 5,200	3.1	50 Watt		PE2053	\$393.41	\$365.87	\$338.33	\$314.73	5
4,000 - 8,000	3.2	50 Watt		PE2054	\$393.41	\$365.87	\$338.33	\$314.73	6
4,000 - 12,400	3.3	20 Watt		PE2059	\$467.89	\$435.14	\$402.39	\$374.31	7
6,000 - 12,400	3.2	50 Watt		PE2055	\$427.06	\$397.17	\$367.27	\$341.65	8
7,000 - 18,000	3.5	20 Watt		PE2060	\$505.79	\$470.38	\$434.98	\$404.63	9
7,500 - 16,000	3.4	40 Watt		PE2056	\$427.06	\$397.17	\$367.27	\$341.65	10
12,000 - 18,000	3.4	40 Watt		PE2057	\$370.87	\$344.91	\$318.95	\$296.70	11

POWER DIVIDERS

50 OHM

Resistive



Ports	Freq. Range (MHz.)	Connector	Gender	Maximum Power	Model No	1-24	25-49	50-99	100+	ROW
2 WAY	0 - 6,000	SMA	Female	1 Watt	PE2069	\$268.88	\$250.06	\$231.24	\$215.10	12
	0 - 12,400	2.92mm			PE2067	\$337.18	\$313.58	\$289.97	\$269.74	13
		SMA			PE2063	\$303.43	\$282.19	\$260.95	\$242.74	14
	0 - 18,000	2.92mm			PE2068	\$359.67	\$334.49	\$309.32	\$287.74	15
		N			PE2064	\$393.41	\$365.87	\$338.33	\$314.73	16
	0 - 26,500	2.92mm			PE2066	\$393.41	\$365.87	\$338.33	\$314.73	17
			PE2065	\$561.98	\$522.64	\$483.30	\$449.58	18		

Reactive



Ports	Freq. Range (MHz.)	Connector	Gender	Maximum Power	Model No	1-24	25-49	50-99	100+	ROW
2 WAY	2 - 500	N	Female	1 Watt	PE2044	\$303.18	\$281.96	\$260.73	\$242.54	19
		BNC			PE2000	\$143.03	\$133.02	\$123.01	\$114.42	20
	SMA	PE2003			\$168.56	\$156.76	\$144.96	\$134.85	21	
	500 - 1,000	SMA		10 Watt	PE2008	\$280.99	\$261.32	\$241.65	\$224.79	22
		N			PE2032	\$449.60	\$418.13	\$386.66	\$359.68	23
	800 - 2,500	SMA		30 Watt	PE2074	\$268.83	\$250.01	\$231.19	\$215.06	24
		N			PE2071	\$215.12	\$200.06	\$185.00	\$172.10	25
	1,000 - 2,000	SMA		50 Watt	PE2011	\$249.32	\$231.87	\$214.42	\$199.46	26
		N			PE2033	\$449.60	\$418.13	\$386.66	\$359.68	27

50 OHM

Reactive



Ports	Freq. Range (MHz.)	Connector	Gender	Maximum Power	Model No	1-24	25-49	50-99	100+	ROW			
2 WAY	2,000 - 4,000	SMA	Female	10 Watt	PE2014	\$225.21	\$209.45	\$193.68	\$180.17	1			
		N			PE2040	\$720.10	\$669.69	\$619.29	\$576.08	2			
	2,000 - 8,000	SMA			PE2026	\$354.35	\$329.55	\$304.74	\$283.48	3			
					PE2028	\$449.60	\$418.13	\$386.66	\$359.68	4			
	2,000 - 18,000	SMA			PE2017	\$293.86	\$273.29	\$252.72	\$235.09	5			
					PE2035	\$505.79	\$470.38	\$434.98	\$404.63	6			
	2,000 - 8,000	N			PE2020	\$280.99	\$261.32	\$241.65	\$224.79	7			
					PE2036	\$505.79	\$470.38	\$434.98	\$404.63	8			
	7,000 - 12,400	SMA			PE2030	\$505.79	\$470.38	\$434.98	\$404.63	9			
					PE2023	\$307.38	\$285.86	\$264.35	\$245.90	10			
	8,000 - 12,400	N			PE2037	\$568.46	\$528.67	\$488.88	\$454.77	11			
8,000 - 18,000			SMA	PE2007	\$280.99	\$261.32	\$241.65	\$224.79	12				
	PE2075	\$376.39		\$350.04	\$323.70	\$301.11	13						
	PE2072	\$322.63		\$300.05	\$277.46	\$258.10	14						
3 WAY	2 - 200	BNC	Female	10 Watt	PE2045	\$487.75	\$453.61	\$419.47	\$390.20	15			
		N			PE2001	\$280.99	\$261.32	\$241.65	\$224.79	16			
	2 - 500	SMA			PE2047	\$276.38	\$257.03	\$237.69	\$221.10	17			
					BNC	PE2004	\$370.87	\$344.91	\$318.95	\$296.70	18		
	10 - 1,000	SMA			PE2009	\$370.87	\$344.91	\$318.95	\$296.70	19			
					N	PE2038	\$703.94	\$654.66	\$605.39	\$563.15	20		
	500 - 1,000	SMA			PE2076	\$537.81	\$500.16	\$462.52	\$430.25	21			
					N	PE2073	\$430.25	\$400.13	\$370.02	\$344.20	22		
	4 WAY	800 - 2,500			SMA	Female	10 Watt	PE2012	\$415.81	\$386.70	\$357.60	\$332.65	23
								N	PE2039	\$730.59	\$679.45	\$628.31	\$584.47
		1,000 - 2,000			SMA			PE2015	\$449.60	\$418.13	\$386.66	\$359.68	25
PE2031			\$467.18	\$434.48				\$401.77	\$373.74	26			
2,000 - 4,000		SMA	PE2029	\$867.54	\$806.81			\$746.08	\$694.03	27			
			N	PE2018	\$370.87			\$344.91	\$318.95	\$296.70	28		
2,000 - 8,000		SMA	PE2041	\$674.35	\$627.15			\$579.94	\$539.48	29			
			N	PE2021	\$370.87			\$344.91	\$318.95	\$296.70	30		
4,000 - 8,000		SMA	PE2042	\$618.21	\$574.94			\$531.66	\$494.57	31			
			N	PE2027	\$419.66			\$390.28	\$360.91	\$335.73	32		
7,000 - 12,400		SMA	PE2024	\$393.41	\$365.87			\$338.33	\$314.73	33			
	N		PE2043	\$674.35	\$627.15	\$579.94	\$539.48	34					
8,000 - 18,000	SMA	Female	1 Watt	PE2006	\$427.06	\$397.17	\$367.27	\$341.65	35				
				12,000 - 18,000	N	PE2046	\$597.49	\$555.67	\$513.84	\$477.99	36		
PE2002	\$449.60					\$418.13	\$386.66	\$359.68	37				
2,000 - 4,000	BNC			PE2034	\$505.79	\$470.38	\$434.98	\$404.63	38				
				2 - 500	N	PE2005	\$618.21	\$574.94	\$531.66	\$494.57	39		
2 - 500	BNC					Female	1 Watt	PE2005	\$618.21	\$574.94	\$531.66	\$494.57	39
				PE2005	\$618.21			\$574.94	\$531.66	\$494.57	39		

See Our Website For Real-Time Stock Availability!

Couplers and Dividers

EHF or Extremely High Frequency has frequencies ranging from 30 to 300GHz.



Free Freight Available
via UPS Ground
to USA & Canada



Real-Time Stock
Levels & Pricing
On Our WebSite



Toll-Free Technical
Support
(866) 727-8376



Same-Day Shipping,
Even Custom
Cable Assemblies

75 OHM

Reactive

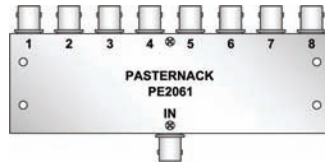

Ports	Freq. Range (MHz.)	Connector	Gender	Maximum Power	Model No	1-24	25-49	50-99	100+	R O W
2 WAY	2 - 500	BNC	Female	1 Watt	PE2048	\$293.86	\$273.29	\$252.72	\$235.09	1
	10 - 1,000	BNC	Female	1 Watt	PE2062	\$303.43	\$282.19	\$260.95	\$242.74	2
4 WAY	2 - 500	BNC	Female	1 Watt	PE2049	\$325.88	\$303.07	\$280.26	\$260.70	3
8 WAY	2 - 500	BNC	Female	1 Watt	PE2061	\$561.98	\$522.64	\$483.30	\$449.58	4

MISC. RF. COMPONENTS

CONNECTOR CAPS

Caps



SMA

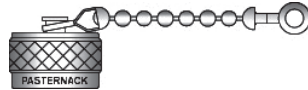

N



N

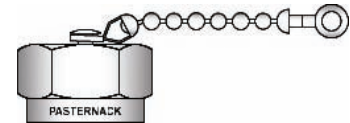

7/16 DIN

Connector	Gender	Compatible With	Chain	Model No	1-24	25-49	50-99	100+	R O W
SMA	Male	50 OHM	No	PE6024	\$7.14	\$6.64	\$6.14	\$5.71	5
			Yes	PE6019	\$8.16	\$7.59	\$7.02	\$6.53	6
	Female		No	PE6120	\$16.36	\$15.21	\$14.07	\$13.09	7
			Yes	PE6119	\$16.36	\$15.21	\$14.07	\$13.09	8
SSMA	Male	50 OHM	No	PE6020	\$8.36	\$7.77	\$7.19	\$6.69	9
N	Male	50 OHM	No	PE6017	\$5.47	\$5.09	\$4.70	\$4.38	10
			Yes	PE6016	\$5.17	\$4.81	\$4.45	\$4.14	11
	Female		No	PE6116	\$6.28	\$5.84	\$5.40	\$5.02	12
			Yes	PE6018	\$7.60	\$7.07	\$6.54	\$6.08	13
TNC	Male	50 OHM	No	PE6144	\$6.43	\$5.98	\$5.53	\$5.14	14
			Yes	PE6023	\$7.03	\$6.54	\$6.05	\$5.62	15
	Female		No	PE6143	\$8.56	\$7.96	\$7.36	\$6.85	16
			Yes	PE6021	\$8.51	\$7.91	\$7.32	\$6.81	17
7/16 DIN	Male	50 OHM	Yes	PE6057	\$32.37	\$30.10	\$27.84	\$25.90	18
	Female		Yes	PE6058	\$32.88	\$30.58	\$28.28	\$26.30	19
UHF	Male	50 OHM	No	PE6017-UHF	\$5.47	\$5.09	\$4.70	\$4.38	20
			Yes	PE6016-UHF	\$5.17	\$4.81	\$4.45	\$4.14	21
SMC	Plug	50 OHM	Yes	PE6123	\$11.70	\$10.88	\$10.06	\$9.36	22
		75 OHM	Yes	PE6126	\$25.43	\$23.65	\$21.87	\$20.34	23
		50 OHM	Yes	PE6124	\$11.70	\$10.88	\$10.06	\$9.36	24
SC	Male	50 OHM	Yes	PE6117	\$82.33	\$76.57	\$70.80	\$65.86	25
	Female		Yes	PE6118	\$70.68	\$65.73	\$60.78	\$56.54	26
HN	Male	50 OHM	No	PE6113	\$14.69	\$13.66	\$12.63	\$11.75	27
			Yes	PE6059	\$20.37	\$18.94	\$17.52	\$16.30	28
	Female		No	PE6115	\$19.96	\$18.56	\$17.17	\$15.97	29
			Yes	PE6114	\$21.13	\$19.65	\$18.17	\$16.90	30
SMB	Plug	50 OHM	Yes	PE6121	\$17.63	\$16.40	\$15.16	\$14.10	31
		75 OHM	Yes	PE6125	\$25.89	\$24.08	\$22.27	\$20.71	32
		50 OHM	Yes	PE6122	\$8.56	\$7.96	\$7.36	\$6.85	33

Caps

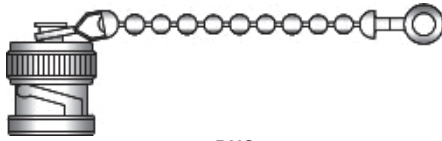

BNC



C

Connector	Gender	Compatible With	Chain	Model No	1-24	25-49	50-99	100+	ROW
BNC	Male	50 OHM	No	PE6014	\$3.50	\$3.26	\$3.01	\$2.80	1
			Yes	PE6013	\$6.03	\$5.61	\$5.19	\$4.82	2
	Female		No	PE6108	\$5.83	\$5.42	\$5.01	\$4.66	3
			Yes	PE6015	\$4.91	\$4.57	\$4.22	\$3.93	4
C	Male	50 OHM	No	PE6109	\$14.69	\$13.66	\$12.63	\$11.75	5
			Yes	PE6046	\$15.45	\$14.37	\$13.29	\$12.36	6
	Female		No	PE6111	\$18.75	\$17.44	\$16.13	\$15.00	7
	Female		Yes	PE6110	\$19.66	\$18.28	\$16.91	\$15.73	8

Shorts

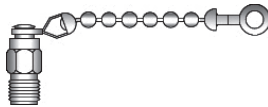

SMA



N



BNC

Connector	Gender	Compatible With	Chain	Model No	1-24	25-49	50-99	100+	ROW
SMA	Male	50 OHM	No	PE6006	\$15.81	\$14.70	\$13.60	\$12.65	9
			Yes	PE6131	\$18.49	\$17.20	\$15.90	\$14.79	10
	Female		No	PE6007	\$17.18	\$15.98	\$14.77	\$13.74	11
			Yes	PE6132	\$18.75	\$17.44	\$16.13	\$15.00	12
N	Male	50 OHM	No	PE6022	\$15.05	\$14.00	\$12.94	\$12.04	13
			Yes	PE6129	\$17.88	\$16.63	\$15.38	\$14.30	14
	Female		No	PE6031	\$16.16	\$15.03	\$13.90	\$12.93	15
			Yes	PE6130	\$19.96	\$18.56	\$17.17	\$15.97	16
TNC	Male	50 OHM	No	PE6133	\$15.05	\$14.00	\$12.94	\$12.04	17
			Yes	PE6134	\$18.75	\$17.44	\$16.13	\$15.00	18
	Female		No	PE6135	\$15.05	\$14.00	\$12.94	\$12.04	19
			Yes	PE6136	\$18.75	\$17.44	\$16.13	\$15.00	20
BNC	Male	50 OHM	No	PE6012	\$7.71	\$7.17	\$6.63	\$6.17	21
			Yes	PE6127	\$13.48	\$12.54	\$11.59	\$10.78	22
	Female		No	PE6030	\$10.39	\$9.66	\$8.94	\$8.31	23
			Yes	PE6128	\$14.49	\$13.48	\$12.46	\$11.59	24

Misc. RF Components

DC BLOCKS



SMA

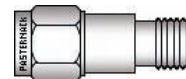

2.92mm

Impedance	Connector	Frequency Range (MHz.)	Type	Max. V (V)	Model No	1-24	25-49	50-99	100+	ROW
50 OHM	SMA	10 - 18,000	Inner	200	PE8210	\$94.54	\$87.92	\$81.30	\$75.63	25
				950	PE8250	\$95.55	\$88.86	\$82.17	\$76.44	26
			Outer	200	PE8211	\$162.08	\$150.73	\$139.39	\$129.66	27
				950	PE8212	\$186.95	\$173.86	\$160.78	\$149.56	28
	2.92mm	10 - 26,500	Inner	200	PE8222	\$213.30	\$198.37	\$183.44	\$170.64	29
				950	PE8223	\$231.29	\$215.10	\$198.91	\$185.03	30
			Outer	200	PE8224	\$320.66	\$298.21	\$275.77	\$256.53	31
				950	PE8224	\$320.66	\$298.21	\$275.77	\$256.53	31



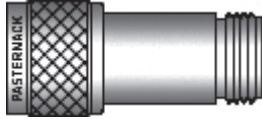

N

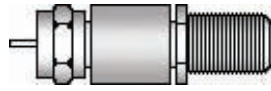

F



BNC

Impedance	Connector	Frequency Range (MHz.)	Type	Max. V (V)	Model No	1-24	25-49	50-99	100+	ROW	
50 OHM	2.92mm	10 - 40,000	Inner	200	PE8225	\$578.85	\$538.33	\$497.81	\$463.08	1	
			Outer		PE8226	\$870.73	\$809.78	\$748.83	\$696.58	2	
			Inner/Outer		PE8227	\$953.77	\$887.01	\$820.24	\$763.02	3	
	2.4mm	100 - 50,000	Inner	75	PE8237	\$1,177.45	\$1,095.03	\$1,012.61	\$941.96	4	
			Outer		PE8238	\$1,530.69	\$1,423.54	\$1,316.39	\$1,224.55	5	
			Inner/Outer		PE8239	\$1,530.69	\$1,423.54	\$1,316.39	\$1,224.55	6	
	N	10 - 18,000	Inner	200	PE8213	\$116.07	\$107.95	\$99.82	\$92.86	7	
					950	PE8251	\$133.15	\$123.83	\$114.51	\$106.52	8
					PE8214	\$156.20	\$145.27	\$134.33	\$124.96	9	
			Outer	200	PE8215	\$210.51	\$195.77	\$181.04	\$168.41	10	
					950	PE8219	\$179.00	\$166.47	\$153.94	\$143.20	11
					PE8252	\$201.75	\$187.63	\$173.51	\$161.40	12	
	TNC	10 - 4,000	Inner/Outer	200	PE8220	\$214.06	\$199.08	\$184.09	\$171.25	13	
					PE8221	\$275.87	\$256.56	\$237.25	\$220.70	14	
PE8216					\$149.01	\$138.58	\$128.15	\$119.21	15		
BNC	10 - 4,000	Outer	200	PE8217	\$181.99	\$169.25	\$156.51	\$145.59	16		
				PE8218	\$247.25	\$229.94	\$212.64	\$197.80	17		
				PE8234	\$201.75	\$187.63	\$173.51	\$161.40	18		
75 OHM	N	100 - 4,000	Inner/Outer	200	PE8235	\$216.90	\$201.72	\$186.53	\$173.52	19	
					PE8236	\$285.45	\$265.47	\$245.49	\$228.36	20	
					PE8240	\$78.99	\$73.46	\$67.93	\$63.19	21	
	F	10 - 2,000	Outer	200	PE8241	\$139.48	\$129.72	\$119.95	\$111.58	22	
					PE8242	\$164.56	\$153.04	\$141.52	\$131.65	23	
					PE8231	\$206.31	\$191.87	\$177.43	\$165.05	24	
	BNC	100 - 4,000	Inner/Outer	200	PE8232	\$170.44	\$158.51	\$146.58	\$136.35	25	
					PE8233	\$273.14	\$254.02	\$234.90	\$218.51	26	

Misc. RF Components

BIAS TEES



SMA



2.92mm

Impedance	Frequency Range (MHz.)	Max. V (V)	Max. I (mA)	Connector	Bias Connector	Model No	1-24	25-49	50-99	100+	ROW
50 OHM	0.1 - 12,400	24	750	SMA	Solder Pin	PE1606	\$382.01	\$355.27	\$328.53	\$305.61	27
	0.1 - 18,000					PE1607	\$458.57	\$426.47	\$394.37	\$366.86	28
	0.1 - 26,500					PE1608	\$909.34	\$845.69	\$782.03	\$727.47	29
	0.1 - 40,000	25	250	2.92mm	SMA Female	PE1609	\$1,524.81	\$1,418.07	\$1,311.34	\$1,219.85	30
	0.1 - 50,000					PE1610	\$1,878.00	\$1,746.54	\$1,615.08	\$1,502.40	31
	10 - 2,500	100	2,500	SMA	Solder Pin	PE1611	\$235.44	\$218.96	\$202.48	\$188.35	32
	10 - 4,000			N		PE1612	\$231.49	\$215.29	\$199.08	\$185.19	33
	10 - 6,000			SMA		PE1613	\$301.71	\$280.59	\$259.47	\$241.37	34
				N		PE1614	\$294.31	\$273.71	\$253.11	\$235.45	35
	100 - 6,000			SMA		PE1615	\$263.66	\$245.20	\$226.75	\$210.93	36
				N		PE1616	\$294.31	\$273.71	\$253.11	\$235.45	37
	250 - 2,500	50	500	SMA	PE1604	\$219.68	\$204.30	\$188.92	\$175.74	38	
	500 - 10,000			PE1617	\$529.80	\$492.71	\$455.63	\$423.84	39		
	1000 - 5,000			N	PE1618	\$582.80	\$542.00	\$501.21	\$466.24	40	
						PE1605	\$353.24	\$328.51	\$303.79	\$282.59	41
						PE1603	\$208.33	\$193.75	\$179.16	\$166.66	42

FILTERS

SMA Connectors

Bandpass Filters



Bandpass Filters



Bandpass Filters

Description	Bandpass Frequency (MHz)	Rejection (MHz)	Max. Insertion Loss (dB)	Model No	1-24	25-49	50-99	100+	ROW
ISM & RFID	902 - 928	± 100	1.5	PE8700	\$376.39	\$350.04	\$323.70	\$301.11	1
ISM, WiFi, Bluetooth, Zigbee	2,400 - 2,500	± 400	1	PE8701	\$376.39	\$350.04	\$323.70	\$301.11	2
ISM, WiFi	5,725 - 5,875	± 600	1	PE8702	\$376.39	\$350.04	\$323.70	\$301.11	3
GPS L1	1,565 - 1,585	± 100	1.5	PE8703	\$376.39	\$350.04	\$323.70	\$301.11	4
GPS L2	1,217 - 1,237	± 100	1.3	PE8704	\$430.25	\$400.13	\$370.02	\$344.20	5
GSM	824 - 849	± 100	1.5	PE8705	\$376.39	\$350.04	\$323.70	\$301.11	6
	869 - 894	50dB at ± 100		PE8706	\$376.39	\$350.04	\$323.70	\$301.11	7
PCS	1,850 - 1,910	50dB at ± 250	1.5	PE8707	\$376.39	\$350.04	\$323.70	\$301.11	8
	1,930 - 1,990			PE8708	\$376.39	\$350.04	\$323.70	\$301.11	9
UMTS	1,920 - 1,980	50 dB at ± 250	1.5	PE8709	\$376.39	\$350.04	\$323.70	\$301.11	10
UMTS/AWS	1,710 - 1,770	50 dB at ± 250	1.5	PE8710	\$376.39	\$350.04	\$323.70	\$301.11	11
	2,110 - 2,170			PE8711	\$376.39	\$350.04	\$323.70	\$301.11	12
WIMAX	2,500 - 2,700	50 dB at ± 900	1	PE8712	\$376.39	\$350.04	\$323.70	\$301.11	13
	3,300 - 3,700	50 dB at ± 1,900	0.75	PE8713	\$376.39	\$350.04	\$323.70	\$301.11	14
	4,900 - 5,900	50 dB at ± 5,000		PE8714	\$376.39	\$350.04	\$323.70	\$301.11	15

Lowpass Filters



Lowpass Filters

Description	Bandpass Frequency (MHz)	Rejection (MHz)	Max. Insertion Loss (dB)	Model No	1-24	25-49	50-99	100+	ROW
-	DC - 30	60 dB at + 60	1	PE8723	\$253.33	\$235.60	\$217.86	\$202.66	16
	DC - 100	60 dB at + 200		PE8719	\$253.33	\$235.60	\$217.86	\$202.66	17
	DC - 225	60 dB at + 450		PE8722	\$253.33	\$235.60	\$217.86	\$202.66	18
	DC - 300	60 dB at + 600		PE8724	\$253.33	\$235.60	\$217.86	\$202.66	19
	DC - 400	60 dB at + 800		PE8726	\$253.33	\$235.60	\$217.86	\$202.66	20
	DC - 700	60 dB at + 1,400		PE8727	\$253.33	\$235.60	\$217.86	\$202.66	21
	DC - 1,000	60 dB at + 2,000		PE8720	\$253.33	\$235.60	\$217.86	\$202.66	22
	DC - 2,000	60 dB at + 4,000		PE8721	\$253.33	\$235.60	\$217.86	\$202.66	23
	DC - 3,000	60 dB at + 6,000		PE8725	\$253.33	\$235.60	\$217.86	\$202.66	24

Highpass Filters



Highpass Filters

Description	Bandpass Frequency (MHz)	Rejection (MHz)	Max. Insertion Loss (dB)	Model No	1-24	25-49	50-99	100+	ROW
-	30 - 300	60 dB at - 15	1	PE8717	\$278.66	\$259.15	\$239.65	\$222.93	25
	100 - 750	60 dB at - 50		PE8716	\$278.66	\$259.15	\$239.65	\$222.93	26
	300 - 1,000	60 dB at - 150		PE8718	\$278.66	\$259.15	\$239.65	\$222.93	27
	1,000 - 2,500	60 dB at - 500		PE8715	\$278.66	\$259.15	\$239.65	\$222.93	28

CONNECTOR IDENTIFIER

SPECIFICATIONS SHOWN ARE INTENDED FOR IDENTIFICATION PURPOSES ONLY











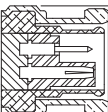
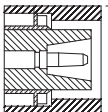
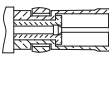
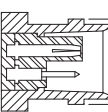
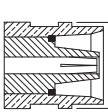
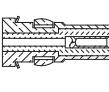
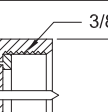
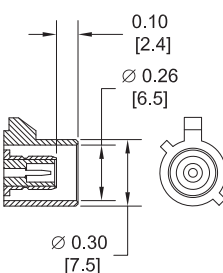
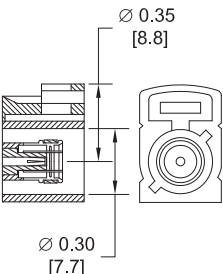
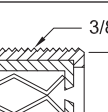

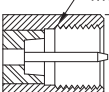









1.0/2.3 SLIDE ON	PLUG	
	JACK	
1.85 mm**	MALE	
	FEMALE	
2.4 mm**	MALE	
	FEMALE	
2.92 mm*	MALE	
	FEMALE	
3.5 mm*	MALE	
	FEMALE	
7 mm	PLUG	
	JACK	
7/16	PLUG	
	JACK	
3/4-20 TWINAX	MALE	
	FEMALE	
10-32	MALE	
	FEMALE	
BANANA	PLUG	
	JACK	
BNC	MALE	
	FEMALE	
REVERSE POLARITY BNC	MALE	
	FEMALE	
75 OHM BNC	MALE	
	FEMALE	

*SMA, 2.92mm, & 3.5mm CONNECTORS WILL MATE MECHANICALLY & ELECTRICALLY TO EACH OTHER.

**1.85mm & 2.4mm CONNECTORS WILL MATE MECHANICALLY & ELECTRICALLY TO EACH OTHER.

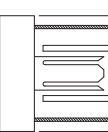
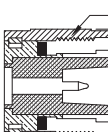
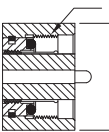
CONNECTOR IDENTIFIER

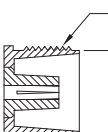
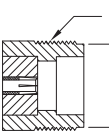
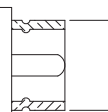
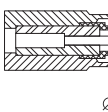
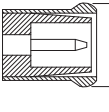
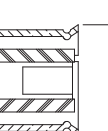

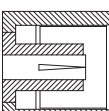
SPECIFICATIONS SHOWN ARE INTENDED FOR IDENTIFICATION PURPOSES ONLY

BNC TWINAX	PLUG	 Ø 0.57" [14.5mm]	C	MALE	 Ø 0.75" [19.1mm]	D SUBMINIATURE	PLUG	 Ø 0.19" [4.8mm]		
	JACK	 Ø 0.44" [11.1mm]		FEMALE	 Ø 0.60" [15.2mm]		RECEPTACLE	 Ø 0.15" [3.9mm]		
F	MALE	 3/8-32 7/16 HEX	FAKRA	PLUG	 0.10 [2.4] Ø 0.26 [6.5] Ø 0.30 [7.5]	FAKRA	JACK	 Ø 0.35 [8.8] Ø 0.30 [7.7]		
	FEMALE	 3/8-32 Ø 0.34 [8.5]		COMPLETE KEY CODE INFO	PLUG		 Ø 0.37 [9.5]	PLUG	 M8 X P.75 Ø 0.37 [9.5]	
FAKRA	CODE	JACK	PLUG	COLOR	APPLICATION	CODE	JACK	PLUG	COLOR	APPLICATION
	A			BLACK	RADIO WITH PHANTOM SUPPLY	H			VIOLET	GPS: TELEMATICS AND NAVIGATION
	B			WHITE	RADIO WITHOUT PHANTOM SUPPLY	I			BEIGE	BLUETOOTH
	C			BLUE	GPS: TELEMATICS OR NAVIGATION	K			CURRY	RADIO WITH I.F. OUTPUT (ANTENNA DIVERSITY)
D			BORDEAUX	GSM: CELLULAR PHONE	Z			WATER BLUE	NEUTRAL CODING	
GR874	MALE	 Ø 0.81 [20.6]	HN	MALE	 3/4-20 Ø 0.90 [22.9]	LC	MALE	 1-1/4-18 1-1/2 HEX		
	FEMALE	 Ø 0.67 [17.1]		FEMALE	 3/4-20 Ø 0.67 [17.1]		FEMALE	 1-1/4-18 Ø 1.17 [29.6]		
UMCX	PLUG	 Ø 0.08 [2.0]	MC-CARD	PLUG	 Ø 0.087 [2.2]	MCX	PLUG	 Ø 0.15 [3.7]		
	JACK	 Ø 0.10 [2.5]		JACK	 Ø 0.20 [5.0]		JACK	 Ø 0.20 [5.0]		

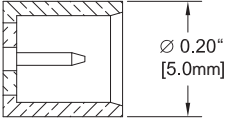
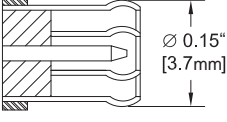
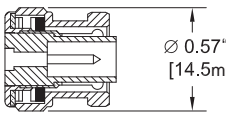
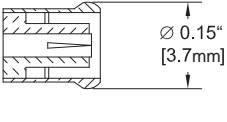
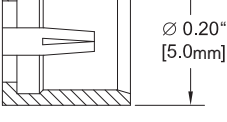

CONNECTOR IDENTIFIER

SPECIFICATIONS SHOWN ARE INTENDED FOR IDENTIFICATION PURPOSES ONLY

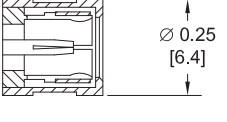
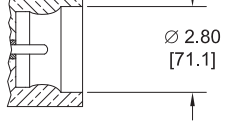
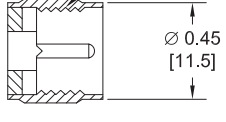
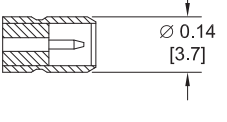
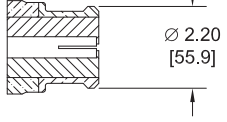
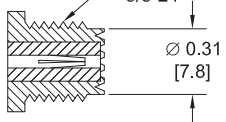
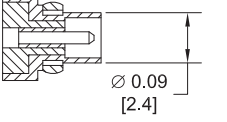
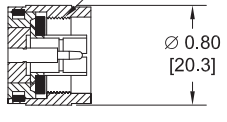
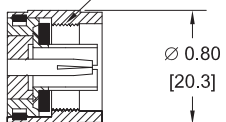
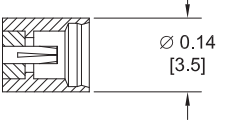
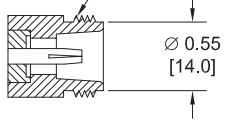
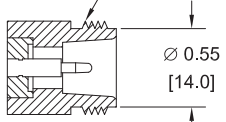
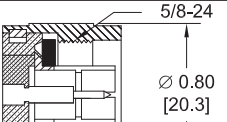
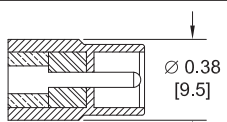
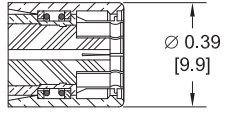
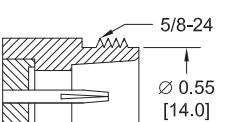
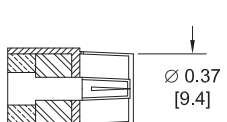
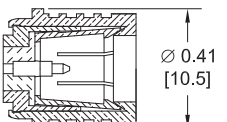
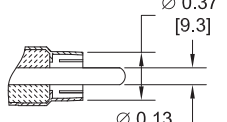
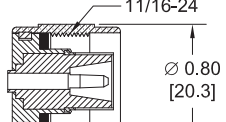
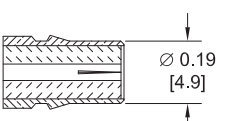
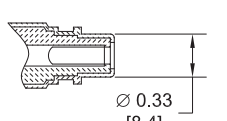
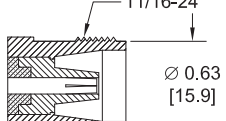
REVERSE POLARITY MCX	PLUG	 Ø 0.20" [5.0mm]	75 OHM MCX	PLUG	 Ø 0.15" [3.7mm]	MHV	MALE	 Ø 0.57" [14.5mm]
	JACK	 Ø 0.15" [3.7mm]		JACK	 Ø 0.20" [5.0mm]		FEMALE	 Ø 0.44" [11.1mm]
MINI 75 OHM SMB	PLUG	 Ø 0.25 [6.4]	MINI SMP	MALE	 Ø 2.80 [71.1]	MINI-UHF	MALE	 3/8-24 Ø 0.45 [11.5]
	JACK	 Ø 0.14 [3.7]		FEMALE	 Ø 2.20 [55.9]		FEMALE	 3/8-24 Ø 0.31 [7.8]
MMCX	PLUG	 Ø 0.09 [2.4]	N	MALE	 5/8-24 Ø 0.80 [20.3]	REVERSE POLARITY N	MALE	 5/8-24 Ø 0.80 [20.3]
	JACK	 Ø 0.14 [3.5]		FEMALE	 5/8-24 Ø 0.55 [14.0]		FEMALE	 5/8-24 Ø 0.55 [14.0]
75 OHM N	MALE	 5/8-24 Ø 0.80 [20.3]	PAL	PLUG	 Ø 0.38 [9.5]	POSITIVE SNAP		 Ø 0.39 [9.9]
	FEMALE	 5/8-24 Ø 0.55 [14.0]		JACK	 Ø 0.37 [9.4]			
OMA	MALE	 Ø 0.41 [10.5]	RCA	PLUG	 Ø 0.37 [9.3] Ø 0.13 [3.2]	SC	MALE	 11/16-24 Ø 0.80 [20.3]
	FEMALE	 Ø 0.19 [4.9]		JACK	 Ø 0.33 [8.4]		FEMALE	 11/16-24 Ø 0.63 [15.9]

CONNECTOR IDENTIFIER

SPECIFICATIONS SHOWN ARE INTENDED FOR IDENTIFICATION PURPOSES ONLY

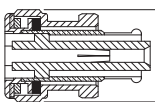
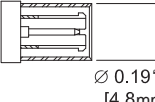
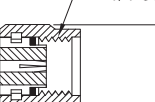
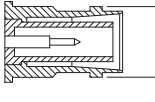
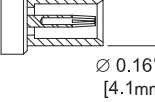
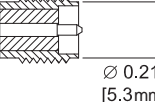
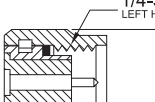
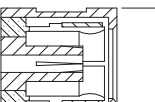
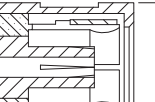
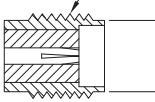
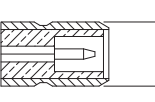
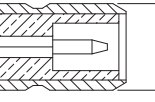
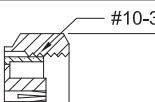
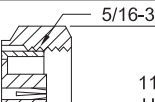
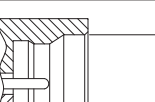
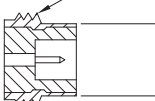
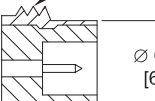
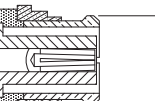
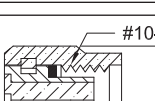
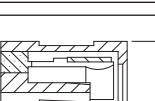
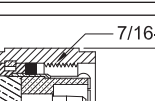
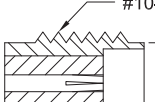
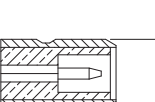
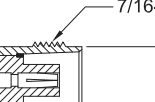
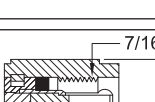
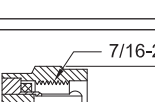
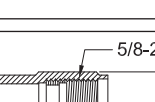
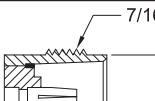
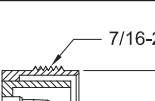
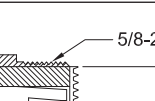
SHV	PLUG	 Ø 0.57" [14.5mm]	SMA*	MALE	 Ø 0.19" [4.8mm]	REVERSE POLARITY SMA	MALE	 1/4-36 5/16 HEX
	JACK	 Ø 0.44" [11.1mm]		FEMALE	 Ø 0.16" [4.1mm]		FEMALE	 1/4-36 Ø 0.21" [5.3mm]
SMA REVERSE THREAD	MALE	 1/4-36 LEFT HAND THREAD 5/16 HEX	SMB	PLUG	 Ø 0.25 [6.4]	75 OHM SMB	PLUG	 Ø 0.37 [9.2]
	FEMALE	 1/4-36 LEFT HAND THREAD Ø 0.21 [5.3]		JACK	 Ø 0.14 [3.7]		JACK	 Ø 0.24 [6.2]
SMC	PLUG	 #10-32 1/4 HEX	75 OHM SMC	PLUG	 5/16-32 11/32 HEX	SMP	MALE	 Ø 3.68 [93.5]
	JACK	 #10-32 Ø 0.14 [3.7]		JACK	 5/16-32 Ø 0.24 [6.2]		FEMALE	 Ø 3.34 [84.8]
SSMA	MALE	 #10-36 1/4 HEX	SSMB	PLUG	 Ø 0.18 [4.7]	TNC	MALE	 7/16-28 Ø 0.59 [15.0]
	FEMALE	 #10-36 Ø 0.16 [4.1]		JACK	 Ø 0.10 [2.6]		FEMALE	 7/16-28 Ø 0.38 [9.6]
75 OHM TNC	MALE	 7/16-28 Ø 0.59 [15.0]	REVERSE POLARITY TNC	MALE	 7/16-28 Ø 0.59 [15.0]	UHF	MALE	 5/8-24 Ø 0.70 [17.8]
	FEMALE	 7/16-28 Ø 0.38 [9.6]		FEMALE	 7/16-28 Ø 0.38 [9.6]		FEMALE	 5/8-24 Ø 0.55 [14.0]

*SMA, 2.92mm & 3.5mm CONNECTORS WILL MATE MECHANICALLY & ELECTRICALLY TO EACH OTHER.



Free Freight Available
via UPS Ground
to USA & Canada



Real-Time Stock
Levels & Pricing
On Our WebSite



Toil-Free Technical
Support
(866) 727-8376



Same-Day Shipping,
Even Custom
Cable Assemblies

MOUNTING HOLES

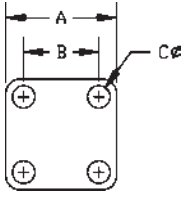

CODE	A	B	C
A01	.500	.340	.102
A02	.687	.500	.109
A03	.687	.500	#3-56 TAP
A04	.687	.500	.125
A05	1.000	.718	.125
A06	.750	.531	.140
A07	.750	.531	.125
A08	1.190	.906	.125
A09	.687	.500	#4-40 TAP
A10	.687	.500	.136
A11	1.250	.975	.147
A12	2.000	1.440	.257
A13	1.000	.718	.141
A14	1.000	.718	.144
A15	.687	.500	.104
A16	.750	.531	.136
A17	.375	.232	.067
A18	.625	.437	.094
A19	1.000	.718	#6-32 TAP
A20	.500	.340	#2-56 TAP
A21	1.250	.975	.142
A22	.375	.232	.093

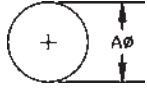

CODE	A
F01	.250
F02	.500
F03	.630
F04	1.200
F05	.380
F06	.450
F07	.200
F08	.362
F09	.220
F10	.317
F11	4.83mm
F12	.390

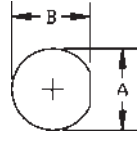

CODE	A	B
B01	.195	.177
B02	.250	.235
B03	.330	.295
B04	.380	.350
B05	.440	.410
B06	.512	.480
B07	.760	.720
B08	.565	.537
B09	.314	.296
B10	.140	.126
B11	.695	.655
B12	.625	.575
B13	.405	.361
B14	.277	.252
B15	.630	.596
B16	.317	.285
B17	.284	.268

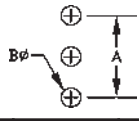

CODE	A	B
J01	.200	.046

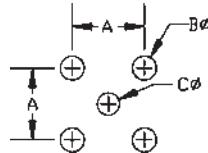

CODE	A	B	C
D01	.200	.067	.062
D02	.200	.067	.046
D03	.100	.031	.031
D04	.200	.052	.052
D05	.260	.067	.043
D06	.200	.052	.047
D07	.200	.055	.043
D08	.200	.067	.035
D09	.200	.055	.028
D10	.200	.055	.035
D11	.320	.091	.031
D12	.400	.062	.062
D13	.320	.091	.091
D14	.340	.091	.043
D15	.164	.067	.091
D16	.500	.126	.440
D17	.380	.083	.043

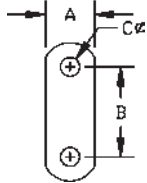

CODE	A	B	C
C01	.223	.481	.102
C02	.260	.481	.102
C03	.192	.328	.067
C04	.640	1.000	.125
C05	.275	.481	.102
C06	.230	.354	.067
C07	.188	.328	.093

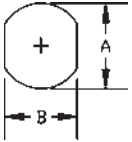

CODE	A	B
G01	.640	.546
G02	.380	.340
G03	.765	.712
G04	.362	.323
G05	.236	.197
G06	.217	.177
G07	.380	.310
G08	1.161	1.000

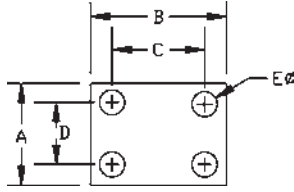

CODE	A	B	C	D	E
E01	.375	.500	.340	.222	.093

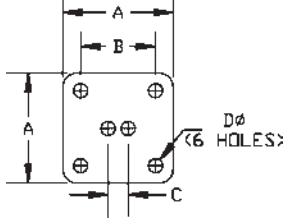

CODE	A	B	C	D
H01	.687	.500	.125	.045

PASTERNAK ENTERPRISES -- REACH PRODUCT COMPLIANCE PROGRAM

What is REACH Compliance?

Regulation (EC) No. 1907/2006 of the European Parliament and of the Council of 18 December 2006 is commonly referred to as REACH (Registration, Evaluation, Authorization, and Restriction of Chemicals). The REACH regulation became effective on June 1, 2007 to streamline and improve the former legislative framework for chemicals available in the European Union (EU) and European Economic Area (EEA) countries.

The objective of REACH is to improve protection of human health and the protection of the environment from the exposure to chemicals. REACH compliance is mandatory for products manufactured in, or imported into the European Union (EU).

As outlined by the REACH regulation, any organization manufacturing, importing, using or placing a substance, mixture, article or product on the EU market will be responsible for ensuring that the component substances are in compliance with REACH regulations.

Determining REACH Compliance of Pasternack Products:

Pasternack Enterprises does not currently either manufacture or import any chemical substances into the EU on their own or in articles (products) in quantities of 1 ton or more per year. In addition, products imported by Pasternack Enterprises' customers do not contain chemical substances intended to be released during the normal and reasonably foreseeable conditions of the product's use as defined by the REACH regulation and existing guidance.

However, under REACH, there is an obligation to ensure that articles do not contain <0.1% by weight of Substances of Very High Concern (SVHCs). SVHCs are substances that may cause cancer or other serious health or environmental effects and thus face restriction or outright bans, and are listed in a regularly-updated 'Candidate list'. The current Candidate list can be downloaded from the European Chemicals Agency (ECHA) website:

http://echa.europa.eu/chem_data/authorisation_process/candidate_list_table_en.asp



For each part that has been found to comply with the REACH SVHC reporting requirements, we show an indication of compliance adjacent to the part number using this symbol:

All products displaying this symbol on our website are assured to contain no SVHCs as defined by the Candidate List displayed on the Pasternack REACH certificate. When you locate the product you need on our website, please click on the "Product ID or Part Number". You will see the "REACH symbol" for the specific part. Click on this symbol to view the Certificate of REACH Compliance (printable if needed) for the specific product as well as the applicable ECHA SVHC Candidate list Date.

Pasternack Enterprises - REACH Product Compliance Program:

At Pasternack Enterprises, we recognize our responsibility as a worldwide supplier of RF, Microwave and Fiber Optic Products subject to the REACH regulations. We have completed a comprehensive effort internally and with our supply chain to determine the REACH compliance of our products. You will find our Reach Symbol adjacent to all products on our website that have been determined by Pasternack and our supply chain to contain less than 0.1% by weight of the REACH substances. You will also see the applicable ECHA SVHC Candidate List Date. "Please refer to our website at www.Pasternack.com.

The Pasternack Enterprises REACH Product Compliance Program is implemented in accordance with Regulation No. 1907/2006 of the European Parliament and the Council of 18 December 2006. Pasternack has implemented a REACH compliance program to address this legislation. Pasternack Enterprises does not currently either manufacture or import any chemical substances into the EU on their own or in articles (products) in quantities of 1 ton or more per year. In addition, products imported by Pasternack Enterprises' customers do not contain chemical substances intended to be released during the normal and reasonably foreseeable conditions of the product's use as defined by the REACH regulation and existing guidance. Thus, Pasternack Enterprises does not currently have a direct REACH obligation to pre-register substances. Pasternack's REACH Product Compliance is determined by a certification from our supply chain. A Pasternack product is deemed to be REACH compliant when it does not contain Substances of Very High Concern (SVHCs) beyond the specified concentration limits of less than 0.1% by weight as outlined in REACH 1907/2006/EU regulation.

Need More Information?

If you have questions regarding REACH Product Certification on Pasternack's products, please contact the Pasternack REACH Compliance Team via email at REACH@Pasternack.com or by calling Toll-Free within North America at 1-866-PASTERNAK (1-866-727-8376). International customers, please call +1-949-261-1920.



Free Freight Available
via UPS Ground
to USA & Canada



Real-Time Stock
Levels & Pricing
On Our WebSite



Toll-Free Technical
Support
(866) 727-8376



Same-Day Shipping,
Even Custom
Cable Assemblies

PASTERNAK ENTERPRISES RoHS COMPLIANCE PROGRAM

Lead-free solder is now available for all cable assemblies upon request or online at www.Pasternack.com.

What is RoHS Compliance?

The European Union set forth the RoHS (Restriction of Hazardous Substances) Directive to establish environmental guidelines and legislation to reduce the presence of six (6) materials deemed hazardous to the environment. To comply, products entering the EU must not have a homogeneous presence of these materials above the following levels by weight percentage:

- Lead (Pb) < 0.1%
- Mercury (Hg) < 0.1%
- Cadmium (Cd) < 0.01%
- Hexavalent Chromium (CrVI) < 0.1%
- Polybrominated Biphenyls (PBB) < 0.1%
- Polybrominated Diphenyl Esters (PBDE) < 0.1%

At Pasternack, we recognize our responsibility as a supplier of coax connectors, cable assemblies, and components used within electronic-based systems and products that are targeted for RoHS compliance. We are fully committed to offering RoHS compliance on the majority of our products. We have completed a comprehensive evaluation and analysis program both internally and with our suppliers to establish and publish RoHS compliant statements for our products on our website.

Determining Pasternack RoHS Compliance

To determine if the product in our catalog is RoHS Compliant, please first refer to our website at www.Pasternack.com. For each part, we show an indicator of compliance using this symbol:



All products displaying this symbol on our website have been certified as RoHS Compliant. Click on this symbol to view the Certificate of RoHS Compliance for this product.

We recognize that you may have specific questions regarding RoHS certification on Pasternack's components and products. We will be happy to process all such requests as quickly as possible. Please direct any such requests to Pasternack Enterprises Technical Support via email at TechSupport@Pasternack.com or by calling Toll-Free within North America at 1-866-PASTERNAK (866-727-8376). International customers, please use +1-949-261-1920.

Methods Determining RoHS Compliance

RoHS Compliance is determined by a combination of supplier certification and engineering design verification. In most cases, Pasternack's products were determined to be RoHS Compliant. In many cases, the Compliance was through a stated Exemption to the RoHS Directive. As a supplier of coaxial connectors, adapters, and RF components, Pasternack uses materials such as Brass and Stainless Steel which contain lead as a percentage of weight above the 0.1% threshold, but are allowed through the Exemptions as of the October 21st, 2005 RoHS Directive amendment. Pasternack uses these Exemptions to the RoHS Directive where applicable.

What are the Exemptions?

RoHS Directive text as of the Oct 21st, 2005 amendment is underlined, and how it applies to Pasternack products is indicated below each Exemption.

ANNEX to ROHS DIRECTIVE 2002/95/EC

"Applications of lead, mercury, cadmium, hexavalent chromium, polybrominated biphenyls (PBB) or polybrominated diphenyl ethers (PBDE) which are exempted from the requirements of Article 4(1)":

5. Lead in glass of cathode ray tubes, electronic components and fluorescent tubes.
Some Pasternack products use resistive and/or dielectric inks that contain lead in a glass phase and fall under this exemption 5.
6. Lead as an alloying element in steel containing up to 0.35% lead by weight, aluminum containing up to 0.4% lead by weight and as a copper alloy containing up to 4% lead by weight.
Most Pasternack products use metal alloys that contain lead below the maximum concentration values specified under this exemption 6. Specifically: aluminum alloys, brass, stainless steel, beryllium copper and phosphor bronze.
7. Lead in solders for servers, storage and storage array systems, network infrastructure equipment for switching, signaling, transmission as well as network management for telecommunications.

All Pasternack coaxial cable assemblies are made using solder containing lead (unless lead-free solder is specified), and may be used in network infrastructure equipment and therefore would fall under this exemption 7. This exemption is application specific, however, and we therefore leave it up to our customer to determine whether this exemption applies to their application.

Pasternack has loaded new part numbers for cable assemblies using lead-free solder on our website, using the format PE3xxxxLF-yy, where "xxxx" identifies the part using the existing corresponding item number, and "yy" identifies the length in inches. For example, PE3067LF-24 is the same as PE3067-24 (BNC Male to BNC Male, RG58C/U), except it uses lead-free solder to be fully ROHS Compliant.

MAILING LIST CHANGES

If you receive more than one catalog with the same name and address, please notify Pasternack and pass the catalog along to a friend. Also, if you do not require multiple copies to the same company address, contact a sales representative to verify and modify your mailing information. A forms-based communications method to add, delete or modify mailing information is available at www.pasternack.com. By clicking "Contact Us", and then clicking "Remove Name from Mailing List", you may complete the form to request a change to your mailing preferences. In addition, by clicking "Catalog", and then clicking "Request a Printed Catalog", you may add your contact information to our mailing list. Please note service opt-in and opt-out options located on the forms. Alternatively, you may mail, email, telephone or fax Pasternack your request.

PLACING YOUR ORDER

► **By Telephone: 866-PASTERNAK (866-727-8376)**
US & Canada, or 949-261-1920

Our friendly sales representatives are ready to serve you from 5:00am to 5:30pm Pacific Standard Time (PST), Monday through Friday. For the most efficient service, please have ready a list of quantities and part numbers and, if paying by credit card, your MasterCard, VISA, American Express or Discover card. Note: Calls may be recorded or monitored for quality and training purposes.

► **By Fax: 949-261-7451**

Our fax lines can be accessed 7 days a week, 24 hours a day. Orders received after 4:00pm PST will be promptly processed and shipped the next business day. Please include your daytime phone number and/or email address in case we have any questions about your order.

► **By Internet: www.Pasternack.com**
or Email: sales@pasternack.com

Order online 7 days a week, 24 hours a day using our online ordering system. Just search for the items you want and add them to your shopping cart. Internet orders entered after 4:00 pm PST will be promptly processed and shipped the next business day.

► **By Mail: Simply Mail Your Order To:**
Pasternack Enterprises, Inc.
17802 Fitch
PO Box 16759
Irvine, CA 92623-6759 USA

International customers, please see "International Orders" below for additional information.

Terms and Conditions of Sale:

The following from Pasternack's Binding Terms and Conditions of Sale are provided for your convenience. A complete documentation of the Binding Terms and Conditions of Sale may be found in the back of the catalog, or on Pasternack's website at <http://www.pasternack.com/TermsOfSale.aspx>. Any questions or clarifications may be answered by contacting Customer Service at (+1) 949-261-1920 or by any of the methods listed above.

Minimum Order:

A minimum order of \$50.00 is required. There is no minimum line item required.

Handling Charge:

A \$10.00 handling charge applies to all orders less than \$100.00. This fee will be waived on orders of \$100.00 or more.

Ground Freight is Free:

On UPS Ground orders, there is no charge for shipping for USA & Canada orders of \$100.00 or greater. Otherwise, shipping or freight charges and insurance will be paid by the customer. All sales are made FOB Point (as defined by the INCOTERMS 2000) in Irvine, CA USA. Shipping or freight charges from Pasternack's Irvine, CA factory are prepaid and added to the invoice or billed collect.

Same-Day Shipment:

Same-day shipment will apply to orders received Monday through Friday, prior to 4:00pm PST.

- All UPS air and surface options
- All FedEx air options (with an approved account number)
- Most other shipping options, including DHL (with an approved account number) and USPS

Counter-to-Counter Shipping:

For your urgent order requiring our fastest shipping method, we will place your order on the next available flight from Santa Ana-Orange County John Wayne International Airport (Airport code: SNA) to the destination you specify. Please call for details.

Payment Terms:

Pasternack offers a number of convenient payment methods:

For United States customers, we offer check, money order, MasterCard, VISA, American Express, Discover, and C.O.D. as well as open account credit to qualified institutions and businesses. Payment must be made in US Dollars.

For Canadian customers, we offer all of the above payment options except C.O.D.
For International customers, see International Orders.

Open Account Credit:

Net 30 Days terms are available to businesses, schools and agencies subject to credit approval. Approval can begin by submitting a completed Credit Application, which can be found online at: www.Pasternack.com/CreditApplication.aspx

EFT/Wire Transfers:

Please contact us for details. We will inform you of the total amount which will include shipping charges and any applicable wire transfer fees. Orders will not be accepted until funds have been received in full.

WELLS FARGO BANK

420 Montgomery St.
San Francisco, CA 94104 USA
Account Number: 4270 0000 0000 0000 1
Routing Number: 121000248
SWIFT Number: WFBUS6S

International Orders:

In addition to the United States and its territories, Pasternack accepts international orders. All orders of international origin are exported from the US in accordance with the Export Administration Regulations. Diversion contrary to US Law is prohibited. Please see Pasternack's Binding Terms and Conditions of Sale for full details.

Pasternack has international distributors for the following countries:

Asia-Pacific: Australia, China PRC, India, Indonesia, Japan, Korea, Malaysia, New Zealand, Singapore, Taiwan, Thailand

Europe: Czech Republic, Denmark, Finland, France, Germany, Ireland, Italy, Norway, Slovakia, Sweden, Switzerland, Turkey, United Kingdom

Middle East: Israel

To access their complete contact information, please see our International Distributors section in this catalog.

International Shipping Charges:

Shipping or freight charges and insurance will be paid by the customer. All sales are made FOB Point (as defined by the INCOTERMS 2000) in Irvine, CA USA. We ship orders by UPS, FedEx (with an approved account number), or DHL (with approved account number) with delivery in 2 to 3 days to most locations worldwide.

International Taxes and Duties:

Customer is responsible for duties and taxes.



Real-Time Stock Levels & Pricing On Our WebSite



Toll-Free Technical Support (866) 727-8376



Same-Day Shipping, Even Custom Cable Assemblies

BINDING TERMS AND CONDITIONS OF SALE

The following are the terms and conditions ("Terms and Conditions") for the sale of products ("Products") by Pasternack Enterprises, Inc. ("Pasternack") to Pasternack's customers ("Customers"). Please read this agreement carefully. Any different or additional terms set forth in customer's purchase order or similar communication are objected to and shall not be binding on the company unless a separate agreement has been signed by an authorized officer of the company. By placing an order for products from the company, or by accepting delivery of the products described on the applicable packing slip, bill of lading and/or invoice received with the products, you agree to be bound by and accept these terms and conditions of sale.

1. ACCEPTANCE AND CANCELLATION OF ORDERS

All orders are subject to acceptance by Pasternack in writing by a duly authorized agent of Pasternack; any written acknowledgement of receipt of an order shall not, in and of itself, constitute such acceptance. Orders accepted and processed by Pasternack may not be cancelled by Customer except as covered by the Limited Warranty, all sales are final. Cable Assemblies and Non-Standard Products are also Non-Cancelable/Non-Refundable ("NC/NR"). Non-Standard Parts are defined as Products which are special orders, custom orders, orders for non-standard products, products not customarily in stock or orders for value-added products. In the event of cancellation or other withdrawal of an order for any reason and without limiting any other remedy which Pasternack may have as a result of such cancellation or other withdrawal, reasonable cancellation or restocking charges, which shall include all expenses then incurred and commitments made by Pasternack, shall be paid by Customer to Pasternack. Customer requests to reschedule are subject to acceptance by Pasternack in its sole discretion. Orders may not be rescheduled after the order has been submitted by Pasternack to the shipment carrier.

2. PRICES

Orders are billed at the prices (in US dollars) in effect at the time of shipment. Prices will be as specified by Pasternack and will be applicable for the period specified in Pasternack's quote. If no period is specified, quoted prices will be applicable for thirty (30) days. The catalog reflects the latest pricing information available at the time of printing. Prices shown in the catalog are subject to change without notice. Prices are subject to change in the event of a change in Pasternack's costs or other circumstances beyond Pasternack's reasonable control. Prices are exclusive of taxes, impositions and other charges, including: sales, use, excise, value added and similar taxes or charges imposed by any government authority, international shipping charges, forwarding agent's and broker's fees, bank fees, consular fees, document fees and import duties.

3. TERMS OF PAYMENT

All payments must be in US Dollars, or will be converted to US Dollars using the available exchange rate at the time of purchase.

Credit cards accepted are MasterCard, VISA, Discover, and American Express credit cards, purchase cards and major bank debit cards. Payment via net thirty (30) days is available to businesses, schools and agencies or as otherwise specified by Pasternack subject to approved credit.

For International Orders

Credit cards accepted are MasterCard, VISA, and American Express. Payment via open credit account with Net thirty (30) days can be established for companies having three U.S. references. Prepaid Wire Transfer: You can wire the funds to our bank. We will contact you with the total amount which will include shipping charges and a \$40 wire transfer fee. Orders will not be accepted until funds have been received in full and Purchase Order (PO) has been received. Customer is responsible for duties and taxes.

4. SALES TAX

Only California residents need to remit sales tax. Pasternack does not remit sales tax to states other than California. Any sales tax due that is not collected by Pasternack is the responsibility of the customer.

5. TOLERANCES

All coaxial cable assemblies displayed in the Pasternack catalog and website have a standard cable length tolerance of $\pm 1.5\%$ or $\frac{3}{8}$ inches (0.375"), whichever is greater. Cable Assemblies in excess of this tolerance factor are eligible for repair and / or replacement under the terms of the Pasternack Limited Warranty.

6. DELIVERY AND TITLE

Shipping or freight charges and insurance will be paid by the customer. All sales are made FCA Shipping Point (as defined by the INCOTERMS 2000) in Irvine, CA USA. Shipping or freight charges from Pasternack's Irvine, CA facility are prepaid and added to the invoice, or billed collect. Subject to Pasternack's right of stoppage in transit, delivery of the Products to the carrier will constitute delivery to Customer and title and risk of loss will pass to Customer. Pasternack will make reasonable efforts to initiate shipment and schedule delivery as close as possible to Customer's requested delivery date(s). Customer acknowledges that delivery dates provided by Pasternack are estimates only and that Pasternack will not be liable for failure to deliver on such dates. Selection of the carrier and delivery route will be made by Pasternack unless specifically designated by Customer. Pasternack reserves the right to make deliveries in installments. Delay in delivery of one installment will not entitle Customer to cancel any other installment(s). Delivery of any installment of Products within thirty (30) days after the date requested will constitute a timely delivery. Delivery of a quantity which varies from the quantity specified shall not relieve Customer of the obligation to accept delivery and pay for the Products delivered.

7. PASTERNAK'S LIMITED WARRANTY

All products are covered by a LIMITED WARRANTY for a period of ninety (90) days from the date of shipment when purchased from Pasternack Enterprises, Inc. Customer must notify Pasternack within 90 days from date of shipment of any defective product. An approved Return Materials Authorization (RMA) number must first be obtained from Pasternack prior to the return of any merchandise to Pasternack for inspection under warranty. Shipping charges for all materials returned under this Limited Warranty are to be prepaid by the Customer. This warranty is limited to the original purchaser. Pasternack's liability arising out of any sale of products to Customer is expressly limited to either (1) Credit for the purchase price paid by Customer for such products (without interest), or (2) Repair and/or replacement of such products, found to be defective after inspection by Pasternack, and such remedies shall be exclusive and in lieu of all others. This warranty is in lieu of any and all other warranties, whether oral, written, expressed, implied or statutory. Further, no warranty will apply if the Product has been subject to misuse, neglect, accident or modification, or has been soldered or altered in any way.

All returns must be shipped to:
Pasternack Enterprises, Inc.
17802 Fitch
Irvine, CA 92614 USA

8. LIMITATION OF LIABILITIES

In no event shall Pasternack be liable for any special, incidental or consequential damages of any nature including, but not limited to, damages resulting from loss of profit or revenue, recall costs, claims for service interruptions or failure to supply downtime, testing, installations or removal costs, costs of substitute products, property damage, personal injury, death or legal expenses. Customer's recovery from Pasternack for any claim shall not exceed the purchase price paid by Customer for the goods, irrespective of the nature of the claim, whether in warrant, contract or otherwise. CUSTOMER SHALL INDEMNIFY, DEFEND AND HOLD PASTERNAK HARMLESS FROM ANY CLAIMS brought by any party regarding products supplied by Pasternack and incorporated into the customer's product.

9. STATEMENTS AND ADVICE

If statements or advice, technical or otherwise, are offered or given to Customer, such statements or advice will be deemed to be given as an accommodation to Customer and without charge and Pasternack shall have no responsibility or liability for the content or use of such statements or advice.

10. EXPORT CONTROL

Products purchased or received under these Terms and Conditions are subject to export control laws, restrictions, regulations and orders of the United States. Customer agrees to comply with all applicable export laws, restrictions and regulations of the United States or foreign agencies or authorities, and shall not export, or transfer for the purpose of re-export, any product to any prohibited or embargoed country, including but not limited to The Balkans, Belarus, Burma, Cote d'Ivoire, Cuba, the Democratic Republic of the Congo, Iran, Iraq, North Korea, Sudan, Syria, and Zimbabwe, or to any denied, blocked, or designated person or entity as mentioned in any such United States or foreign law or regulation. Customer represents and warrants that it is not on the Denied Persons, Specially Designated Nationals or Debarred Persons List (as identified by the U.S. Treasury Office of Foreign Asset Control (OFAC) and by the U.S. Department of Commerce, Bureau of Industry and Security (BIS)), or any other United States or other government list of prohibited persons; and otherwise prohibited by United States or other law from purchasing the products or services hereunder. Customer shall be solely responsible to obtain any license to export, re-export or import as may be required.

11. GENERAL

The Terms and Conditions may not be modified or cancelled without Pasternack's written agreement. Accordingly goods furnished and services rendered by Pasternack are sold only on the terms and conditions stated herein. The Terms and Conditions will be governed by and construed in accordance with the laws of the State of California and the applicable laws of the United States of America. If Customer chooses to access the Pasternack Web Site from outside the United States, Customer does so on their own initiative and is responsible for compliance with all applicable local laws.

12. INTELLECTUAL PROPERTY

The drawings, text, product depictions, logos, content, product descriptions, and organization and taxonomy of this catalog and of the described content within this catalog are proprietary to Pasternack and protected by intellectual property laws, including but not limited to United States Copyright law and United States Trademark law. Pasternack owns copyrights in these referenced works as well as the selection, arrangement, coordination and structure of the arranged content and works within this catalog. Use of this catalog does not give you any right to modify, reproduce, transmit, publish, publicly display, adapt, or create derivative works or in any way exploit any of the materials and content of this catalog.

GLOSSARY OF RF TERMS

Absorption: The loss of power resulting from conversion of power into heat.

Albaloy: A "tri-metal" plating finish comprised primarily of copper, tin and zinc which provides good electrical performance. It also provides excellent passive intermodulation (PIM) performance comparable to silver.

Attenuation: Attenuation, measured in decibels (dB), is the reduction in signal power that occurs when a signal travels over long distances.

Bandwidth: The difference between the upper and lower frequencies in a continuous set of frequencies.

Circulator: A passive, three-port device used to control the direction of signal flow in an RF circuit.

Coaxial Cable: A cable with an inner conductor surrounded by a flexible and tubular insulating layer, then surrounded by a tubular conducting shield.

Coaxial Connector: Typically used with coaxial cables, these connectors are designed to maintain shielding and minimize the change in transmission line impedance at the connection. A RF connector is an electrical connector designed to work at radio frequencies.

Contact: The part of an interconnect that interfaces between the connector and the lead or coaxial center conductor on the device being connected.

DC block: A capacitor that allows you to separate Direct Current (DC) voltages along a transmission line.

Decibel (dB): A decibel is a logarithmic unit expressing the ratio of two powers. It is ten times the logarithm to base 10 of the ratio of two powers.

Dielectric: In a coaxial cable, the dielectric is the insulation between the inner and outer conductor. Dielectric influences the electrical properties such as impedance and velocity.

Diode: An electronic device with low resistance that allows current to flow in only one direction.

DWV: Acronym for Dielectric Withstanding Voltage. DWV is the minimum voltage requirement of a connector's insulating material to ensure high voltage surges will not cause dielectric failure.

Ferrule (Coaxial): A short tube used to make solderless connections to a coaxial cable (as in crimping)

Ferrule (FO): A component of a fiber optic connection that aligns and holds a fiber in place.

Fiber Optics: The transmission of radiant energy (or light) through an optical wave guide, generally made of glass or plastic.

Flange: A projection with holes extending a connector or waveguide that permits mounting the connector or waveguide to a panel, or to another mating half.

Frequency: Is a signal of AC alternating current (AC) that swings from a high peak to a negative point. Each swing from crest to trough of the wave is called a cycle. Frequency is the number of cycles per second that is measured in Hz (Hertz), where 1 Hz = 1 CPS (Cycles per second)

Gain: The ratio of power output to the power input of the amplifier in dB.

GHz: Frequency measurement that equals a billion cycles per second. For example, 7 GHz = 7 billion cycles per second.

Impedance: A measurement of resistance calibrated in "Ohms" which varies with frequency.

Insertion Loss: In a transmission system, it is the change in load power due to the insertion of a particular device.

Jacket: On a coaxial cable, it is a non-metallic, outer protective cover applied over an insulated wire or cable.

Land Mobile Radio: Also referred to as LMR, is a wireless communications system intended for terrestrial use, typically by users in vehicles or on foot.

MHz: Frequency measurement that equals a million cycles per second. For example, 3 MHz = 3 million cycles per second.

Microwave: A wavelength on the electromagnetic spectrum lying between the infrared and the radio frequency range. Microwaves extend from 1 GHz to 300 GHz.



Free Freight Available
via UPS Ground
to USA & Canada



Real-Time Stock
Levels & Pricing
On Our WebSite



Toll-Free Technical
Support
(866) 727-8376



Same-Day Shipping,
Even Custom
Cable Assemblies

GLOSSARY OF RF TERMS

MIL: Abbreviation for "Military" (as in Military Standards.)

Mixer: Provides frequency translation from the input signal to the output signal. It is a nonlinear electrical circuit that creates new frequencies from two signals applied to it.

Noise: Random electrical signals, generated by circuit components or by environmental disturbances.

Passive Intermodulation (PIM): Simply put, Passive Intermodulation (PIM) is interference of a signal. PIM is a nonlinear response that occurs when two or more signals are present in a passive device such as a cable, connector, coupler. PIM is typically caused by dissimilar metals or dirty/loose interconnects.

Phase Shift: The change in time experience by voltage or current after passing through a circuit or cable. Phase shift is a delay in time that is commonly expressed in degrees or picoseconds when it relates to connectors or cable assemblies.

Polarization: Describes how a material responds to an applied electric field as well as the way the material changes the electric field.

Propagation: Moving or Transmitting energy along a path.

Pulse: A rapid change in signal level over a relatively short period of time.

Receiver: A device that detects a signal and converts it into an electrical form that is usable by other electronic devices.

Return Loss: Expressed in dB, it is a measure of the amount of reflected power on a transmission line when it is terminated or connected to any passive or active device.

RF Leakage: The amount of signal frequency which radiates (leaks) from the RF connector or cable.

RG/U: Symbol for cables that are made to Government Specification. The "R" stands for Radio Frequency, the "G" means Government, the corresponding number specifies the government approval, and the "U" means it is a universal specification.

Rubber Duck Antenna: An electrically short, omnidirectional antenna used on wireless devices such as GPS receivers. These antennas typically have a flexible plastic shield.

Semi-Rigid: A cable with rigid outer conductor that contains a flexible inner conductor and dielectric that form a coaxial transmission line.

Shielding: The metal sleeve surrounding the conductors in a wire circuit or cable to prevent interference or leakage.

Surface Mount Device: Abbreviated as SMD, it is an active or passive device designed to be soldered to the surface of a printed circuit board.

Temperature: Refers to the minimum and maximum temperatures that a given component can operate at while still meeting all specifications unless otherwise noted.

Termination: Also known as a Load, terminations are used at the end of a transmission line and are designed to absorb RF power with very little reflection, effectively terminating the line.

Torque: Recommended mating torque for industry standard connectors: SMA = 7 to 10 in-lbs; Type-N = 12 to 15 in-lbs; TNC = 12 to 15 in-lbs; 7/16 DIN = 220 to 300 in-lbs.

Twinax Cable: Similar to coax cable, but has two inner conductors instead of one. Typically used for very-short-range applications.

Twinax Connector: Two-Pole symmetrical connectors that maintain a balanced transmission line. Twinax connectors are ideal for applications using shielded twin-wire cables with different impedances in the range of 75 to 95 Ohms.

VSWR: Abbreviation for Voltage Standing Wave Ratio. VSWR is an efficiency measurement of how radio frequency is transmitted from a power source through a transmission line, into a termination (or load).

Waveguide: Used at microwave frequencies, waveguides are metallic transmission lines typically used to interconnect transmitters and receivers with antennas.

Yagi: A directional, shortwave radio antenna consisting of a horizontal conductor with several insulated dipoles parallel to and in the plane of the conductor.

PART NUMBER INDEX

Note: C/R stands for the Column and/or Row location of the specific product on a given page.

Model No.	Page	C/R	Model No.	Page	C/R	Model No.	Page	C/R	Model No.	Page	C/R	Model No.	Page	C/R
PE6152	196	28	PE7029	191	47	PE7132	217	29	PE8225	206	1	PE8724	207	19
PE6153	196	29	PE7030	188	18	PE7133	217	30	PE8226	206	2	PE8725	207	24
PE6154	196	30	PE7031	191	45	PE7134	217	31	PE8227	206	3	PE8726	207	20
PE6155	196	41	PE7032	191	46	PE7135	217	32	PE8231	206	24	PE8727	207	21
PE6156	196	42	PE7033	192	56	PE7136	217	33	PE8232	206	25	PE9000	172	C1
PE6157	196	35	PE7034	192	53	PE7137	217	34	PE8233	206	26	PE9001	172	D3
PE6158	196	36	PE7035	193	59	PE7138	217	35	PE8234	206	18	PE9002	161	A6
PE6159	197	23	PE7036	193	61	PE7139	210	3	PE8235	206	19	PE9003	172	C4
PE6160	196	21	PE7037	193	60	PE7140	210	4	PE8236	206	20	PE9004	165	D6
PE6161	196	20	PE7038	193	62	PE7141	216	7	PE8237	206	4	PE9005	162	A1
PE6162	195	20	PE7039	188	21	PE7142	216	6	PE8238	206	5	PE9006	158	D3
PE6163	195	19	PE7040	189	25	PE7143	216	9	PE8239	206	6	PE9007	157	C6
PE6164	196	19	PE7041	189	32	PE7144	216	8	PE8240	206	21	PE9008	173	C5
PE6165	197	12	PE7042	190	36	PE7145	216	11	PE8241	206	22	PE9009	173	D4
PE6166	197	5	PE7043	190	40	PE7146	216	10	PE8242	206	23	PE9011	173	A5
PE6167	197	2	PE7044	191	49	PE7147	216	14	PE8243	209	7	PE9013	173	A6
PE6168	197	7	PE7045	186	10	PE7148	216	13	PE8244	209	8	PE9063	148	D3
PE6169	197	9	PE7046	185	1	PE7149	216	15	PE8245	209	9	PE9064	160	A3
PE6173	196	13	PE7047	187	15	PE7150	216	24	PE8246	209	10	PE9065	166	D2
PE6174	196	14	PE7048	189	28	PE7151	216	25	PE8247	209	11	PE9066	166	A3
PE6175	196	15	PE7049	188	20	PE7152	216	26	PE8250	205	26	PE9067	147	D1
PE6176	196	26	PE7050	191	51	PE7153	216	27	PE8251	206	8	PE9068	146	A5
PE6177	196	27	PE7051	188	17	PE7154	216	20	PE8252	206	12	PE9069	146	D1
PE6178	196	16	PE7052	188	24	PE7155	216	21	PE8253	209	12	PE9070	146	C6
PE6179	196	17	PE7053	189	30	PE7156	216	22	PE8254	209	13	PE9071	147	A1
PE6180	196	18	PE7054	190	35	PE7157	216	23	PE8300	208	12	PE9072	152	C5
PE6800	233	9	PE7055	190	39	PE7158	216	17	PE8301	208	13	PE9073	152	C6
PE6801	233	8	PE7056	190	43	PE7159	216	18	PE8302	208	14	PE9074	152	A6
PE6802	233	7	PE7057	191	50	PE7160	216	19	PE8303	208	15	PE9075	153	A1
PE6803	233	6	PE7058	192	54	PE7161	185	2	PE8304	208	16	PE9076	149	A5
PE6804	233	5	PE7061	194	64	PE7162	186	9	PE8305	208	17	PE9077	149	B6
PE6805	233	4	PE7062	194	65	PE7300	210	1	PE8306	208	18	PE9078	149	C5
PE6806	233	3	PE7063	194	66	PE7301	210	2	PE8310	209	1	PE9079	149	D6
PE6807	233	1	PE7064	194	67	PE8000	213	15	PE8311	209	2	PE9080	148	A5
PE6808	233	2	PE7065	195	68	PE8001	214	1	PE8312	209	3	PE9081	149	B1
PE6809	232	17	PE7066	199	19	PE8002	214	3	PE8313	209	4	PE9082	148	B6
PE6810	232	16	PE7067	199	18	PE8003	214	5	PE8400	208	1	PE9083	149	A3
PE6811	232	15	PE7068	199	20	PE8004	214	7	PE8401	208	2	PE9084	172	C2
PE6812	232	14	PE7069	199	21	PE8005	214	9	PE8402	208	3	PE9085	172	B2
PE6813	232	13	PE7070	199	8	PE8006	214	11	PE8403	208	4	PE9086	158	C2
PE6814	232	12	PE7071	199	10	PE8007	214	13	PE8404	208	5	PE9087	172	C6
PE6815	232	11	PE7072	199	9	PE8008	214	15	PE8405	208	6	PE9088	164	B4
PE6816	232	9	PE7073	199	12	PE8009	214	17	PE8406	208	7	PE9089	159	D3
PE6817	232	10	PE7074	199	13	PE8010	213	8	PE8410	208	8	PE9090	159	A3
PE6818	233	18	PE7075	199	4	PE8011	213	9	PE8411	208	9	PE9091	162	B6
PE6819	233	17	PE7076	199	5	PE8012	213	10	PE8412	208	10	PE9093	172	D2
PE6820	233	16	PE7077	199	6	PE8013	213	11	PE8413	208	11	PE9094	165	D4
PE6821	233	15	PE7078	199	7	PE8014	213	12	PE8500	215	16	PE9095	165	B5
PE6822	233	14	PE7079	199	15	PE8015	213	13	PE8501	215	17	PE9096	165	B4
PE6823	233	13	PE7080	199	14	PE8016	213	14	PE8502	215	18	PE9097	164	A5
PE6824	233	12	PE7081	199	16	PE8017	214	20	PE8503	215	19	PE9098	164	D4
PE6825	233	10	PE7082	199	17	PE8018	214	21	PE8504	215	20	PE9099	163	A2
PE6826	233	11	PE7083	199	11	PE8019	214	22	PE8505	216	1	PE9100	163	B1
PE6827	234	9	PE7085	191	46	PE8020	214	23	PE8506	216	2	PE9101	158	B6
PE6828	234	8	PE7087	187	12	PE8021	214	24	PE8507	216	3	PE9102	158	D5
PE6829	234	7	PE7088	185	3	PE8022	214	25	PE8508	216	4	PE9103	146	D3
PE6830	234	6	PE7089	185	4	PE8023	214	26	PE8509	216	5	PE9104	149	A4
PE6831	234	5	PE7090	187	14	PE8024	215	1	PE8600	213	4	PE9105	148	C6
PE6832	234	4	PE7100	216	16	PE8025	215	2	PE8601	213	5	PE9106	172	C3
PE6833	234	3	PE7101	216	29	PE8026	215	3	PE8602	213	6	PE9107	166	A1
PE6834	234	1	PE7102	216	12	PE8027	215	4	PE8603	213	7	PE9108	167	B5
PE6835	234	2	PE7103	216	28	PE8028	215	5	PE8650	212	14	PE9109	172	B6
PE7000	186	7	PE7104	217	1	PE8029	215	6	PE8651	212	15	PE9110	164	A4
PE7001	186	8	PE7105	217	2	PE8030	215	7	PE8652	213	1	PE9111	160	B2
PE7002	185	5	PE7106	217	3	PE8031	215	8	PE8653	213	2	PE9112	160	C2
PE7003	185	6	PE7107	217	4	PE8032	215	9	PE8654	213	3	PE9113	160	A2
PE7004	187	16	PE7108	217	5	PE8033	215	10	PE8700	207	1	PE9114	165	A5
PE7005	186	11	PE7109	217	6	PE8034	215	11	PE8701	207	2	PE9115	167	D1
PE7006	199	2	PE7110	217	7	PE8035	215	12	PE8702	207	3	PE9116	171	D2
PE7007	199	3	PE7111	217	8	PE8036	215	13	PE8703	207	4	PE9117	167	A1
PE7008	192	52	PE7112	217	9	PE8037	215	14	PE8704	207	5	PE9118	171	B2
PE7009	191	48	PE7113	217	10	PE8038	215	15	PE8705	207	6	PE9119	167	B1
PE7010	189	27	PE7114	217	11	PE8040	214	19	PE8706	207	7	PE9120	171	C2
PE7011	194	63	PE7115	217	12	PE8200	209	5	PE8707	207	8	PE9121	167	A2
PE7013	188	22	PE7116	217	13	PE8202	209	6	PE8708	207	9	PE9122	171	A3
PE7014	188	23	PE7117	217	14	PE8210	205	25	PE8709	207	10	PE9123	162	B1
PE7015	189	29	PE7118	217	15	PE8211	205	27	PE8710	207	11	PE9124	162	B3
PE7016	189	26	PE7119	217	16	PE8212	205	28	PE8711	207	12	PE9125	160	D6
PE7017	190	34	PE7120	217	17	PE8213	206	7	PE8712	207	13	PE9126	169	C3
PE7018	189	33	PE7121	217	18	PE8214	206	9	PE8713	207	14	PE9127	161	B5
PE7019	190	38	PE7122	217	19	PE8215	206	10	PE8714	207	15	PE9128	158	A4
PE7020	190	37	PE7123	217	20	PE8216	206	15	PE8715	207	28	PE9129	169	D3
PE7021	190	42	PE7124	217	21	PE8217	206	16	PE8716	207	26	PE9130	159	C2
PE7022	190	41	PE7125	217	22	PE8218	206	17	PE8717	207	25	PE9131	159	D4
PE7023	188	19	PE7126	217	23	PE8219	206	11	PE8718	207	27	PE9132	171	B5
PE7024	187	13	PE7127	217	24	PE8220	206	13	PE8719	207	17	PE9135	171	C4
PE7025	189	31	PE7128	217	25	PE8221	206	14	PE8720	207	22	PE9136	171	C5
PE7026	190	44	PE7129	217	26	PE8222	205	29	PE8721	207	23	PE9137	171	D4
PE7027	198	8	PE7130	217	27	PE8223	205	30	PE8722	207	18	PE9138	167	D4
PE7028	199	1	PE7131	217	28	PE8224	205	31	PE8723	207	16	PE9139	167	B4

PART NUMBER INDEX

Note: C/R stands for the Column and/or Row location of the specific product on a given page.

Model No.	Page	C/R	Model No.	Page	C/R	Model No.	Page	C/R	Model No.	Page	C/R	Model No.	Page	C/R
PE9140	167	A5	PE9241	171	A5	PE9334	157	C2	PE9424	153	D2	PE9515	158	B2
PE9141	167	C4	PE9242	167	C2	PE9335	174	C2	PE9425	153	C2	PE9516	170	B5
PE9142	152	B3	PE9243	171	C3	PE9336	174	B4	PE9426	158	A1	PE9517	170	C4
PE9143	152	C3	PE9244	177	B1	PE9337	174	A4	PE9427	157	A6	PE9518	170	A5
PE9144	152	D2	PE9245	178	B1	PE9338	174	D3	PE9428	158	D2	PE9519	170	D4
PE9145	152	A3	PE9246	147	D3	PE9339	174	A3	PE9429	158	C3	PE9520	171	D1
PE9146	151	A2	PE9247	147	B3	PE9340	174	B2	PE9430	148	D6	PE9521	164	D3
PE9147	151	B2	PE9248	178	A1	PE9341	166	D4	PE9431	148	C4	PE9522	170	A3
PE9148	151	C1	PE9249	174	C4	PE9342	166	C4	PE9432	149	B2	PE9523	170	D2
PE9149	151	D1	PE9250	157	B5	PE9343	166	C2	PE9433	148	B5	PE9524	170	A6
PE9150	173	C2	PE9251	150	A1	PE9344	165	A6	PE9434	149	D2	PE9525	170	D3
PE9151	173	D2	PE9252	149	B3	PE9345	163	B6	PE9435	149	D3	PE9526	170	B4
PE9152	173	B2	PE9253	151	A3	PE9346	163	C6	PE9436	154	A5	PE9527	170	C3
PE9153	173	A3	PE9254	151	C2	PE9347	166	B2	PE9437	154	C5	PE9528	170	A4
PE9154	163	B2	PE9255	151	B3	PE9348	165	D5	PE9438	154	A6	PE9529	172	A5
PE9155	162	D4	PE9256	151	D2	PE9349	162	B4	PE9439	149	D4	PE9530	172	D4
PE9158	173	C4	PE9257	162	B5	PE9350	162	C4	PE9440	149	A6	PE9531	163	B4
PE9159	177	A2	PE9258	162	C5	PE9351	157	C3	PE9441	149	B5	PE9532	163	A4
PE9160	177	C2	PE9259	153	D3	PE9352	157	A4	PE9442	149	C6	PE9533	147	C5
PE9163	177	A6	PE9260	153	A4	PE9353	157	D3	PE9443	162	D6	PE9534	147	B5
PE9164	177	B3	PE9261	162	B2	PE9354	157	B4	PE9444	163	D1	PE9535	159	B6
PE9165	166	C1	PE9262	146	C4	PE9355	157	C4	PE9445	162	A6	PE9536	172	A6
PE9166	177	D2	PE9263	159	A4	PE9356	157	D4	PE9446	159	B2	PE9537	172	D6
PE9167	166	D1	PE9264	169	A4	PE9357	157	D1	PE9447	159	C3	PE9538	162	A3
PE9168	177	B6	PE9265	174	D2	PE9358	157	A2	PE9448	159	D2	PE9539	162	A4
PE9169	173	B5	PE9266	174	A1	PE9359	158	A5	PE9449	159	B4	PE9540	162	C2
PE9171	173	B4	PE9267	174	B1	PE9360	161	B1	PE9450	159	C4	PE9541	158	B5
PE9172	172	B3	PE9268	174	C1	PE9361	178	A5	PE9451	155	C6	PE9542	164	A3
PE9173	158	D4	PE9269	172	A2	PE9362	178	B5	PE9452	155	D6	PE9543	164	D2
PE9174	172	A4	PE9270	163	C1	PE9363	178	C5	PE9453	156	A1	PE9544	164	C3
PE9175	173	D5	PE9271	177	D6	PE9364	178	D4	PE9454	155	D1	PE9545	164	B3
PE9178	159	D6	PE9272	176	C6	PE9365	178	B6	PE9455	155	C1	PE9546	146	A4
PE9179	160	B1	PE9273	146	A2	PE9366	178	D5	PE9456	155	A2	PE9547	158	D1
PE9180	160	D1	PE9274	147	B2	PE9367	178	A6	PE9457	155	B1	PE9548	158	D6
PE9181	168	A6	PE9275	149	A2	PE9368	176	D3	PE9458	156	D3	PE9549	158	C6
PE9182	147	C3	PE9276	150	B1	PE9369	176	C3	PE9459	156	A4	PE9550	159	B3
PE9183	160	B3	PE9277	160	B5	PE9370	176	B3	PE9460	155	B5	PE9551	149	D1
PE9184	147	C1	PE9278	161	C6	PE9371	176	A4	PE9461	155	C5	PE9552	159	B5
PE9185	153	B1	PE9279	179	A5	PE9372	163	A6	PE9462	161	D3	PE9553	161	C1
PE9186	174	D5	PE9280	179	C4	PE9373	179	A1	PE9463	161	C3	PE9554	160	C6
PE9187	148	C3	PE9281	167	B3	PE9374	179	B1	PE9464	161	B3	PE9555	164	D6
PE9188	148	A4	PE9282	167	D3	PE9375	179	D4	PE9465	161	A3	PE9556	165	C2
PE9189	157	A3	PE9283	167	A4	PE9376	179	D3	PE9466	171	C1	PE9557	165	B2
PE9191	157	C5	PE9284	167	C3	PE9377	179	A4	PE9467	171	A1	PE9558	165	A3
PE9192	157	D2	PE9285	179	B3	PE9378	179	B4	PE9468	171	B1	PE9559	165	B3
PE9193	169	A2	PE9286	179	A3	PE9379	147	A3	PE9469	170	D6	PE9560	162	C6
PE9194	161	A1	PE9287	163	C2	PE9380	146	D6	PE9470	152	B2	PE9561	163	A1
PE9195	163	A3	PE9288	163	D2	PE9381	146	B5	PE9471	152	A2	PE9562	164	C5
PE9196	160	A5	PE9289	163	C3	PE9382	158	C4	PE9472	152	D1	PE9563	164	A2
PE9198	157	D6	PE9290	163	B3	PE9383	158	B4	PE9473	152	C1	PE9564	164	D5
PE9199	178	D6	PE9291	163	D5	PE9384	149	D5	PE9474	170	B6	PE9565	161	C5
PE9200	168	B4	PE9292	160	C5	PE9385	160	D2	PE9475	152	A1	PE9566	162	C1
PE9201	165	C6	PE9293	174	B5	PE9386	169	A5	PE9476	151	C6	PE9567	169	B3
PE9204	173	A1	PE9294	174	B6	PE9387	169	B5	PE9477	152	B1	PE9568	168	A4
PE9205	169	C1	PE9295	162	D3	PE9388	161	B6	PE9478	151	D6	PE9569	168	A5
PE9206	162	A2	PE9296	169	C4	PE9389	162	A5	PE9479	170	D5	PE9570	160	D4
PE9207	174	A6	PE9297	172	D5	PE9390	158	C5	PE9480	170	C2	PE9571	168	C4
PE9208	174	C5	PE9298	160	B6	PE9391	175	B2	PE9481	158	A6	PE9572	168	C2
PE9209	165	C4	PE9299	160	D5	PE9392	171	D6	PE9482	159	A5	PE9573	168	B3
PE9210	168	D6	PE9300	174	A5	PE9393	171	B6	PE9483	164	B5	PE9574	169	B3
PE9211	174	D1	PE9301	174	D6	PE9394	172	A1	PE9484	172	B4	PE9575	169	D2
PE9212	169	D4	PE9302	171	A4	PE9395	171	C6	PE9485	147	D2	PE9576	169	B1
PE9213	157	A5	PE9303	167	C1	PE9396	175	B6	PE9486	149	C2	PE9577	169	A1
PE9214	151	D3	PE9304	167	D2	PE9397	175	D6	PE9487	148	C5	PE9578	169	C2
PE9215	151	C3	PE9305	167	B2	PE9398	168	B5	PE9488	148	D5	PE9579	169	B4
PE9216	161	A2	PE9306	175	D2	PE9399	148	B4	PE9489	161	A5	PE9580	169	D1
PE9217	161	D1	PE9307	175	C2	PE9400	150	A6	PE9490	161	D6	PE9581	152	C2
PE9218	164	C2	PE9308	175	A2	PE9401	152	D3	PE9491	161	D5	PE9582	176	C1
PE9219	164	B2	PE9309	171	D3	PE9402	152	A4	PE9492	162	D1	PE9583	176	A2
PE9220	169	A6	PE9310	171	B3	PE9403	168	B2	PE9493	152	B5	PE9584	176	B1
PE9221	169	D5	PE9311	158	C1	PE9404	168	A3	PE9494	152	B6	PE9585	176	D1
PE9222	173	C6	PE9312	147	A2	PE9405	168	D2	PE9495	152	D5	PE9586	175	A5
PE9223	173	B6	PE9313	161	B4	PE9406	172	C5	PE9496	152	D6	PE9587	175	C5
PE9224	179	C1	PE9314	161	A4	PE9407	153	C1	PE9497	148	A6	PE9588	175	D4
PE9225	168	C3	PE9315	161	D4	PE9408	149	C3	PE9498	149	A1	PE9589	175	B5
PE9226	164	D1	PE9316	161	C4	PE9409	165	C1	PE9499	148	D4	PE9590	147	A4
PE9227	176	D6	PE9317	160	A4	PE9410	165	A1	PE9500	158	B3	PE9591	147	B4
PE9228	177	A1	PE9318	160	D3	PE9411	150	A5	PE9501	156	A3	PE9592	147	D4
PE9229	173	C3	PE9319	160	C4	PE9412	150	C5	PE9502	156	C3	PE9593	147	A5
PE9230	173	B3	PE9320	160	B4	PE9413	168	B6	PE9503	156	B3	PE9594	147	C4
PE9231	173	A4	PE9321	154	D3	PE9414	165	A2	PE9504	156	D2	PE9595	158	A2
PE9232	173	D3	PE9322	154	B3	PE9415	150	B6	PE9505	146	B1	PE9596	150	D2
PE9233	173	C1	PE9323	154	A4	PE9416	175	A3	PE9506	146	D2	PE9597	150	C2
PE9234	173	B1	PE9324	154	C3	PE9417	175	B3	PE9507	146	C5	PE9598	150	A3
PE9235	173	A2	PE9325	154	C4	PE9418	146	C2	PE9508	146	A6	PE9599	150	B3
PE9236	173	D1	PE9326	154	B4	PE9419	168	C5	PE9509	165	C3	PE9600	150	D1
PE9237	160	A6	PE9327	151	A4	PE9420	172	A3	PE9510	165	D3	PE9601	150	C1
PE9238	162	D2	PE9330	153	B4	PE9421	166	B1	PE9511	151	C4	PE9602	150	A2
PE9239	162	C3	PE9331	153	C5	PE9422	153	B3	PE9512	151	A5	PE9603	150	B2
PE9240	171	D5	PE9332	153	D4	PE9423	153	C3	PE9513	151	D4	PE9604	150	D3



Free Freight Available
via UPS Ground
to USA & Canada



Real-Time Stock
Levels & Pricing
On Our WebSite



Toll-Free Technical
Support
(866) 727-8376



Same-Day Shipping,
Even Custom
Cable Assemblies

PART NUMBER INDEX

Note: C/R stands for the Column and/or Row location of the specific product on a given page.

Model No.	Page	C/R	Model No.	Page	C/R	Model No.	Page	C/R	Model No.	Page	C/R	Model No.	Page	C/R
PE9605	150	C3	PE9695	146	D5	PE9787	161	B2	PE9863/SF	227	15	PE-B159/RD	181	5
PE9606	150	B4	PE9696	166	B5	PE9788	161	D2	PE9864	227	9	PE-B159/WH	181	6
PE9607	150	A4	PE9697	166	D5	PE9789	161	C2	PE9864/NF	227	3	PE-B159/YW	181	7
PE9608	178	A3	PE9698	166	A6	PE9800	231	38	PE9864/SF	227	6	PE-B305	181	8
PE9609	178	C2	PE9699	163	D6	PE9801	231	27	PE9865	231	21	PE-B400	181	19
PE9610	178	D2	PE9700	164	A1	PE9802	231	16	PE9866	231	39	PE-B405	181	20
PE9611	178	B3	PE9701	165	B6	PE9803	231	35	PE9867	231	34	PE-C100	181	21
PE9612	176	B2	PE9702	150	C6	PE9804	231	24	PE9868	231	28	PE-C195	181	22
PE9613	176	D2	PE9703	151	A1	PE9805	231	13	PE9869	231	17	PE-C200	181	23
PE9614	176	C2	PE9704	160	C3	PE9806	231	40	PE9870	231	23	PE-C240	181	24
PE9615	176	A3	PE9705	166	C3	PE9807	231	29	PE9900	76		PE-C300	181	25
PE9616	178	C3	PE9706	166	D3	PE9808	231	18	PE9901	76		PE-C400	181	26
PE9617	178	D3	PE9707	150	D6	PE9809	231	37	PE9902	76		PE-C500	181	27
PE9618	178	A4	PE9708	151	B1	PE9810	231	26	PE9903	76		PE-C600	181	28
PE9619	178	B4	PE9709	166	A4	PE9811	231	15	PE9904	76		PE-P047	181	29
PE9620	147	B1	PE9710	166	B4	PE9812	231	44	PE9905	76		PE-P047LL	182	1
PE9621	146	B4	PE9711	166	B6	PE9813	231	46	PE9906	76		PE-P086	182	2
PE9622	176	D4	PE9712	166	C6	PE9814	231	41	PE9907	76		PE-P086LL	182	3
PE9623	176	C4	PE9713	164	B1	PE9815	231	30	PE9908	76		PE-P141	182	4
PE9624	176	A5	PE9714	164	C1	PE9816	231	19	PE9909	76		PE-P141LL	182	5
PE9625	176	B5	PE9715	156	D4	PE9817	231	33	PE9910	76		PE-P195	182	6
PE9626	175	D3	PE9716	156	C4	PE9818	231	12	PE9911	76		PE-S330	183	23
PE9627	175	A4	PE9717	156	A5	PE9819	231	31	PE9912	76		PE-SR047AL	183	9
PE9628	175	B4	PE9718	156	C6	PE9820	231	22	PE9913	76		PE-SR047FL	183	10
PE9629	175	C4	PE9719	156	D6	PE9821	231	10	PE9914	76		PE-SR401AL	183	11
PE9630	176	A6	PE9720	157	A1	PE9822	231	8	PE9915	76		PE-SR401FL	183	12
PE9631	176	D5	PE9721	157	B1	PE9823	231	6	PE9916	76		PE-SR402-75	183	13
PE9632	177	B4	PE9722	147	C6	PE9824	231	4	PE9917	76		PE-SR402AL	183	14
PE9633	177	A4	PE9723	147	D6	PE9825	231	2	PE9918	163	D3	PE-SR402FL	183	15
PE9634	177	D4	PE9724	148	A1	PE9826	231	48	PE9930	73	13	PE-SR402FLJ	183	16
PE9635	177	C4	PE9725	148	B1	PE9827	231	47	PE9931-B	73	17	PE-SR405AL	183	17
PE9636	163	B5	PE9726	148	A3	PE9828	231	42	PE9931-R	73	18	PE-SR405FL	183	18
PE9637	163	D4	PE9727	148	C2	PE9829	231	20	PE9932-B	74	5	PE-SR405FLJ	183	19
PE9638	163	A5	PE9728	148	D2	PE9830	231	11	PE9932-R	74	6	RG108A/U	183	24
PE9639	163	C5	PE9729	148	B3	PE9831	231	9	PE9933-B	74	1	RG11A/U	181	9
PE9640	156	B1	PE9730	159	C5	PE9832	231	7	PE9933-R	74	2	RG122/U	182	7
PE9641	146	D4	PE9731	159	D5	PE9833	231	5	PE9934-B	75	1	RG141A/U	182	8
PE9642	146	B2	PE9732	149	B4	PE9834	231	3	PE9934-R	75	2	RG142B/U	182	9
PE9643	147	C2	PE9733	149	C4	PE9835	231	1	PE9935-B	74	7	RG174A/U	182	10
PE9644	154	D5	PE9734	177	C3	PE9836	232	8	PE9935-R	74	8	RG178B/U	182	11
PE9645	154	B5	PE9735	178	A2	PE9837	232	7	PE9936-B	74	3	RG179B/U	181	10
PE9646	154	D6	PE9736	178	D1	PE9838	232	6	PE9936-R	74	4	RG180B/U	182	12
PE9647	154	B6	PE9737	175	A6	PE9839	232	5	PE9950	76		RG187A/U	181	11
PE9648	154	C6	PE9738	175	D5	PE9840	232	4	PE9951	76		RG188A/U	182	14
PE9649	154	B1	PE9739	175	C6	PE9841	232	3	PE9952	76		RG188-DS	182	13
PE9650	154	D1	PE9740	176	A1	PE9842	232	2	PE9953	76		RG196A/U	182	15
PE9651	154	C1	PE9741	177	C5	PE9843	232	1	PE9954	76		RG213/U	182	16
PE9652	154	A2	PE9742	177	A5	PE9844	231	45	PE9955	76		RG214/U	182	17
PE9653	148	C1	PE9743	177	B5	PE9845	231	43	PE9956	76		RG216/U	181	12
PE9654	148	D1	PE9744	177	D5	PE9846	231	36	PE9957	76		RG217/U	182	18
PE9655	148	A2	PE9745	154	C2	PE9847	231	32	PE9958	76		RG218/U	182	19
PE9656	148	B2	PE9746	154	B2	PE9848	231	25	PE9959	76		RG219/U	182	20
PE9657	153	B6	PE9747	154	D2	PE9849	231	14	PE9960	76		RG223/U	182	21
PE9658	153	C6	PE9748	154	A3	PE9850	229	44	PE9961	76		RG225/U	182	22
PE9659	153	D6	PE9749	174	C3	PE9850/2F	229	41	PE9962	76		RG302/U	181	13
PE9660	154	A1	PE9750	168	B1	PE9851	229	38	PE9963	76		RG303/U	182	23
PE9661	155	B4	PE9751	167	C6	PE9851/2F	229	35	PE9964	76		RG316/U	182	25
PE9662	155	C4	PE9752	168	C1	PE9852	229	32	PE9965	76		RG316-DS	182	24
PE9663	155	D4	PE9753	167	D6	PE9852/2F	229	29	PE9966	76		RG393/U	182	26
PE9664	155	A5	PE9754	168	D1	PE9853	229	26	PE9967	76		RG400/U	182	27
PE9665	155	D2	PE9755	168	A1	PE9853/SF	229	23	PE91001	153	A2	RG401/U	183	20
PE9666	155	C2	PE9756	167	D5	PE9854	229	20	PE91002	153	B2	RG402/U	183	21
PE9667	155	B2	PE9757	167	A6	PE9854/NF	229	14	PE91003	153	D1	RG405/U	183	22
PE9668	155	A3	PE9758	172	D1	PE9854/SF	229	17	PE91004	169	C6	RG55B/U	182	28
PE9669	146	C1	PE9759	177	B2	PE9855	229	11	PE91005	151	A6	RG58C/U	182	30
PE9670	146	B6	PE9760	177	D1	PE9855/NF	229	5	PE91006	151	B6	RG58-P	182	29
PE9671	146	C3	PE9761	177	A3	PE9855/SF	229	8	PE91007	151	D5	RG59B/U	181	15
PE9672	156	D1	PE9762	156	D5	PE9856	229	2	PE91028	164	C6	RG59-P	181	14
PE9673	156	B2	PE9763	156	C5	PE9856/NF	228	44	PE91029	165	B1	RG59-WHITE	181	16
PE9674	156	A2	PE9764	156	A6	PE9856/SF	228	47	PE91030	159	A6	RG62A/U	183	1
PE9675	156	C2	PE9765	156	B6	PE9857	228	32	PE91031	160	A1	RG6A/U	181	18
PE9676	153	A6	PE9766	155	C3	PE9857/NF	228	26	PE91032	159	C6	RG6-CATV	181	17
PE9677	153	B5	PE9767	155	B3	PE9857/SF	228	29	PE91033	160	C1	RG71B/U	183	2
PE9678	153	D5	PE9768	155	D3	PE9858	228	41	PE91034	157	B6	RG8A/U	183	3
PE9679	153	C4	PE9769	155	A4	PE9858/NF	228	35	PE91035	158	A3	RG8X	183	4
PE9680	175	B1	PE9770	159	D1	PE9858/SF	228	38	PE91036	150	B5			
PE9681	175	C1	PE9771	159	C1	PE9859	228	23	PE91038	165	D1			
PE9682	147	D5	PE9772	159	A1	PE9859/NF	228	17	PE91039	164	B6			
PE9683	147	A6	PE9773	159	B1	PE9859/SF	228	20	PE91040	158	B1			
PE9684	149	C1	PE9774	146	B3	PE9860	228	14	PE91041	150	D4			
PE9685	157	B2	PE9775	170	A1	PE9860/NF	228	8	PE91042	150	D5			
PE9686	169	D6	PE9776	170	B1	PE9860/SF	228	11	PE91043	150	C4			
PE9687	179	B2	PE9777	170	C1	PE9861	228	5	PE-020SR	183	5			
PE9688	179	A2	PE9778	151	B5	PE9861/NF	227	30	PE-034SR	183	6			
PE9689	179	C2	PE9779	151	C5	PE9861/SF	228	2	PE-047SR	183	7			
PE9690	152	C4	PE9780	170	A2	PE9862	227	27	PE-118SR	183	8			
PE9691	152	D4	PE9781	155	D5	PE9862/NF	227	21	PE-B150	181	1			
PE9692	152	B4	PE9782	155	A6	PE9862/SF	227	24	PE-B159/BK	181	2			
PE9693	152	A5	PE9783	164	C4	PE9863	227	18	PE-B159/BL	181	3			
PE9694	146	A3	PE9786	151	B4	PE9863/NF	227	12	PE-B159/GR	181	4			